

MOROSINI[®]
luce & design



EviStyle[®]
Passion for light

plus



MOROSINI[®]
luce & design

+

EviStyle[®]
Passion for light

2010.2011

+
creativity
experience
technology
design

MOROSINI[®]
luce & design

plus

EviStyle[®]
Passion for light

LUCI ITALIANE CREA **PLUS**, UNO STRUMENTO
INDISPENSABILE PER CONOSCERE TUTTE
LE NOVITÀ DEI SUOI DUE BRAND
LEADER NEL SETTORE DELL'ILLUMINAZIONE:
MOROSINI ED EVI STYLE.

PLUS È “+ **CREATIVITÀ + ESPERIENZA**
+ **TECNOLOGIA + DESIGN**”.

PLUS È UN UNICO CATALOGO, O PER MEGLIO DIRE
UN CATALOGO UNICO, IN CUI **LUCI ITALIANE**
HA SCELTO DI RACCHIUDERE TUTTE LE CREAZIONI
DI DUE BRAND DIVERSI PER STILE E ISPIRAZIONI,
MA ACCOMUNATI DALLA PASSIONE PER
LA SPERIMENTAZIONE E PER LA QUALITÀ TOTALE.
PLUS È **MOROSINI + EVI STYLE** ASSIEME PER
PERMETTERVI DI CONSULTARE PIÙ AGEVOLMENTE
LE INFINITE SOLUZIONI D'ILLUMINAZIONE E DESIGN
CHE SAPRANNO SODDISFARE OGNI ESIGENZA
SIA IN TERMINI DI GUSTO CHE DI UTILIZZO.

LUCI ITALIANE HAS CREATED PLUS, A UNIQUE CATALOGUE THAT INCLUDES ALL THE LIGHTING PRODUCTS OF ITS TWO LEADING BRANDS MOROSINI AND EVI STYLE. PLUS STANDS FOR “+ CREATIVITY + EXPERIENCE + TECHNOLOGY + DESIGN”. PLUS IS AN EXCLUSIVE TOOL IN WHICH LUCI ITALIANE HAS INTEGRATED ALL THE ITEMS OF ITS TWO BRANDS WHOSE PRODUCTS - ALTHOUGH DISTINCT IN TERMS OF STYLE - RESULT FROM THE SAME PASSION FOR INNOVATION AND TOTAL QUALITY. PLUS COMBINES MOROSINI + EVI STYLE IN ORDER TO MAKE IT EASIER FOR YOU TO EVALUATE THE INFINITE VARIETY OF LIGHTING AND DESIGN SOLUTIONS AND THUS LET YOU CHOOSE THE ITEMS THAT FULLY SATISFY YOUR NEEDS.

MOROSINI DESCRIVE UNA VIVACE AZIENDA D'ILLUMINAZIONE, ATTENTA ALLE EVOLUZIONI DEL GUSTO E PRONTA A SPERIMENTARE NUOVE FORME E NUOVI LINGUAGGI ARTISTICI. LE SCELTE DI STILE DI MOROSINI SONO RACCHIUSE NELLA SEMPRE CURATA FRESCHEZZA DELLE LINEE E NELL'ASSOLUTA PULIZIA FORMALE DEI MATERIALI IMPIEGATI.

QUESTI ORIENTAMENTI TROVANO GRATIFICAZIONE NELL'ENERGIA CREATIVA DI UN GRUPPO DI DESIGNERS EMERGENTI, PARTICOLARMENTE DEDITI AL DARE FORZA E VALORE ESPRESSIVO ANCHE A MATERIALI INSOLITI, ORIGINALI, NON CONSUETI AL MONDO DELL'ILLUMINAZIONE. LUCE E DESIGN SONO I CONFINI DEL TERRITORIO CREATIVO DI MOROSINI.

EVI STYLE HA SCELTO DI RILANCIARE L'ATMOSFERA DELLO STILE CLASSICO INTERPRETANDOLO ATTRAVERSO IL SEGNO INNOVATIVO DI DESIGNERS CREATIVI. LA COSTANTE RICERCA DI NUOVI MATERIALI E L'EVOLUZIONE DELLE POSSIBILITÀ PRODUTTIVE, ARRICCHISCONO IL VALORE ESTETICO DELLE FORME CLASSICHE PROIETTANDOLE IN UN'ATTUALITÀ FRESCA E RAFFINATA, CON LA TRADIZIONALE PASSIONE DI EVI STYLE.

LUCI ITALIANE, CON I PROPRI BRANDS **MOROSINI** ED **EVI STYLE** RICALCA LA TRADIZIONE DEL MADE IN ITALY E NE FA ELEMENTO DISTINTIVO ED IRRINUNCIABILE: L'AZIENDA PENSA, SPERIMENTA E PRODUCE IN ITALIA E IN EUROPA, A TESTIMONIANZA DI UN ORGOGLIO E DI UNA SAPIENZA COSTRUTTIVA ED ESTETICA CHE SONO UN VALORE IN PIÙ PER LE LAMPADE PRODOTTE. INOLTRE RICERCA E PERSEGUE COMPORTAMENTI ECOCOMPATIBILI IN OGNI FASE DEL PROCESSO PRODUTTIVO, DALLA SCELTA DEI MATERIALI COLORANTI AGLI IMBALLI COMPLETAMENTE RICICLABILI. LA CURA PER LA QUALITÀ DEL LAVORO È UN PUNTO D'ONORE E DI OSTINAZIONE.

MOROSINI IS A RENOWNED MANUFACTURER OF LIGHTING FIXTURES THAT PAYS PARTICULAR ATTENTION TO WORLDWIDE EVOLUTION IN STYLE, AND RESEARCH AND DEVELOPMENT OF NEW DESIGNS AND ARTISTIC EXPRESSIONS. THE MOROSINI RANGE OF PRODUCTS STANDS IN A CLASS OF ITS OWN, THE RESULT OF PREMIUM MATERIALS COMBINED WITH THE INNOVATIVE DESIGNS AND SKILL OF THE COMPANY'S CREATIVE GROUP OF DESIGNERS WHO ARE ESPECIALLY DEDICATED TO ENHANCING THE EXPRESSIVE QUALITIES OF ORIGINAL MATERIALS RARELY USED IN THE LIGHTING SECTOR.

EVI STYLE HAS OPTED TO RELAUNCH A CLASSIC STYLE WITH INCOMPARABLE APPEAL, RESULTING FROM THE INNOVATIVE INTERPRETATIONS OF HIGHLY CREATIVE DESIGNERS.

A PASSION FOR TRADITION AND INNOVATION, COMBINED WITH CONSTANT RESEARCH FOR NEW MATERIALS AND INVENTIVE PRODUCTION TECHNIQUES, ENABLES EVI STYLE TO ENHANCE THE AESTHETIC OF CLASSIC DESIGNS WITH AN UTTERLY REFINED, UP-TO-DATE LOOK.

LUCI ITALIANE, WITH ITS BRANDS **MOROSINI** AND **EVI STYLE**, FINDS ITS DISTINCTIVE FEATURE IN ITS ABILITY TO APPLY "MADE IN ITALY" TRADITIONS IN ORDER TO EXPERIMENT, DESIGN AND CREATE UNIQUE PRODUCTS OFFERING ADDED VALUE IN TERMS OF AESTHETICS AND STYLE BOTH IN ITALY AND THROUGHOUT EUROPE. LUCI ITALIANE ALSO PURSUES AN ECO-COMPATIBLE POLICY IN EVERY STAGE OF THE PRODUCTION PROCESS – FROM CHOICE OF DYES TO PACKAGING MATERIALS THAT CAN BE FULLY RE-CYCLED. WE ARE PROUD OF THE GREAT CARE WE TAKE IN ORDER TO PROVIDE LIGHTING FIXTURES OFFERING TOTAL QUALITY WORKMANSHIP, SUPREME CREATIVITY AND THE ULTIMATE IN DESIGN.





“CHIUNQUE VOGLIA FARE PROGRESSI
NON VIAGGIA PIÙ SU RUOTE,
MA CON LE ALI [...]”

Vilém Flusser, Filosofia del design

“WHO EVER WANTS TO MAKE PROGRESS,
DOESN'T RUN ON WHEELS
BUT WITH THE WINGS (...)”

Vilém Flusser, Design Philosophy

designers

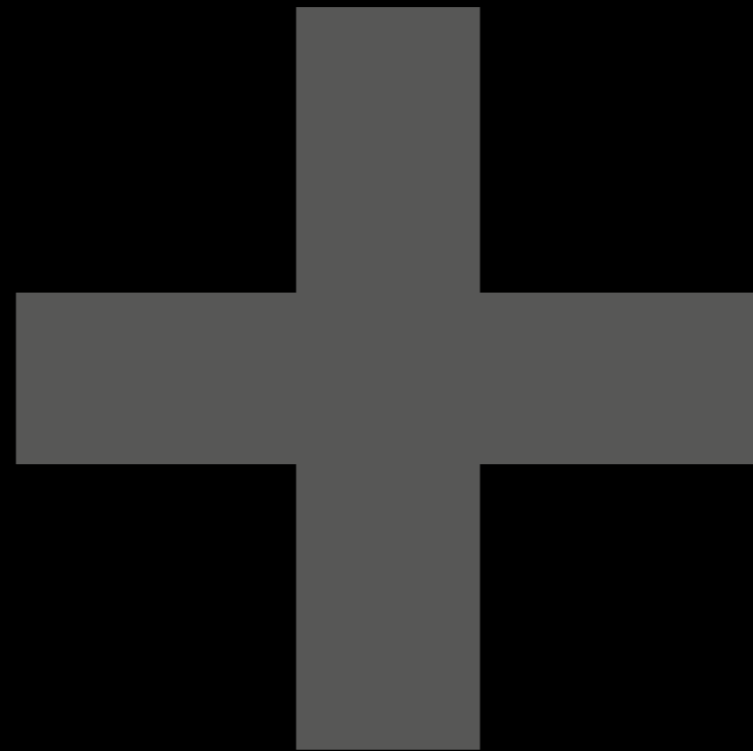

designers

andrea
LAZZARI



serena
PAPAIT



massimo
TONETTO



stefano
CAVAZZANA



ITLAB



brian
RASMUSSEN



carmen
ANDRETTA



simone
BELLAN



sandro
SANTANTONIO



andrea
CANTÙ





+ index

+

+

10

MOROSINI[®]
luce & design

- ALASKA 96
- ASIA 108
- BROADWAY 132
- BUTTERFLY 150
- CLUB 118
- COOL 100
- DIAMOND 18
- DICE 50
- DRESS 140
- DRESS R 122
- EGG 158
- EYE 168
- EVO 164
- FLAT 72
- FLORIAN 56
- FOG 38
- FUNZIONE 200
- GIGLIO 82
- NEMESI 178
- RIBBON 62
- ROUND 88
- SKETCH 172
- SPRING 26
- SUNRISE 186
- WASHI 12
- WAVE 114
- YOUNG + YOUNG MINI 154
- ZEUS 194

202

Evi Style[®]
Passion for light

- CURLY 266
- FALL 238
- FRISÉ + FRISÉ MINI 220
- GROOVE 270
- QUEEN M 230
- RETRÒ + RETRÒ SOFT 210
- ROLL 256
- ROMANCE 260
- SYMPHONY 204
- TESSUTI 280
- YORK 246

INDICE FOTOGRAFICO 302
PHOTOGRAPHIC INDEX

LEGENDA 308

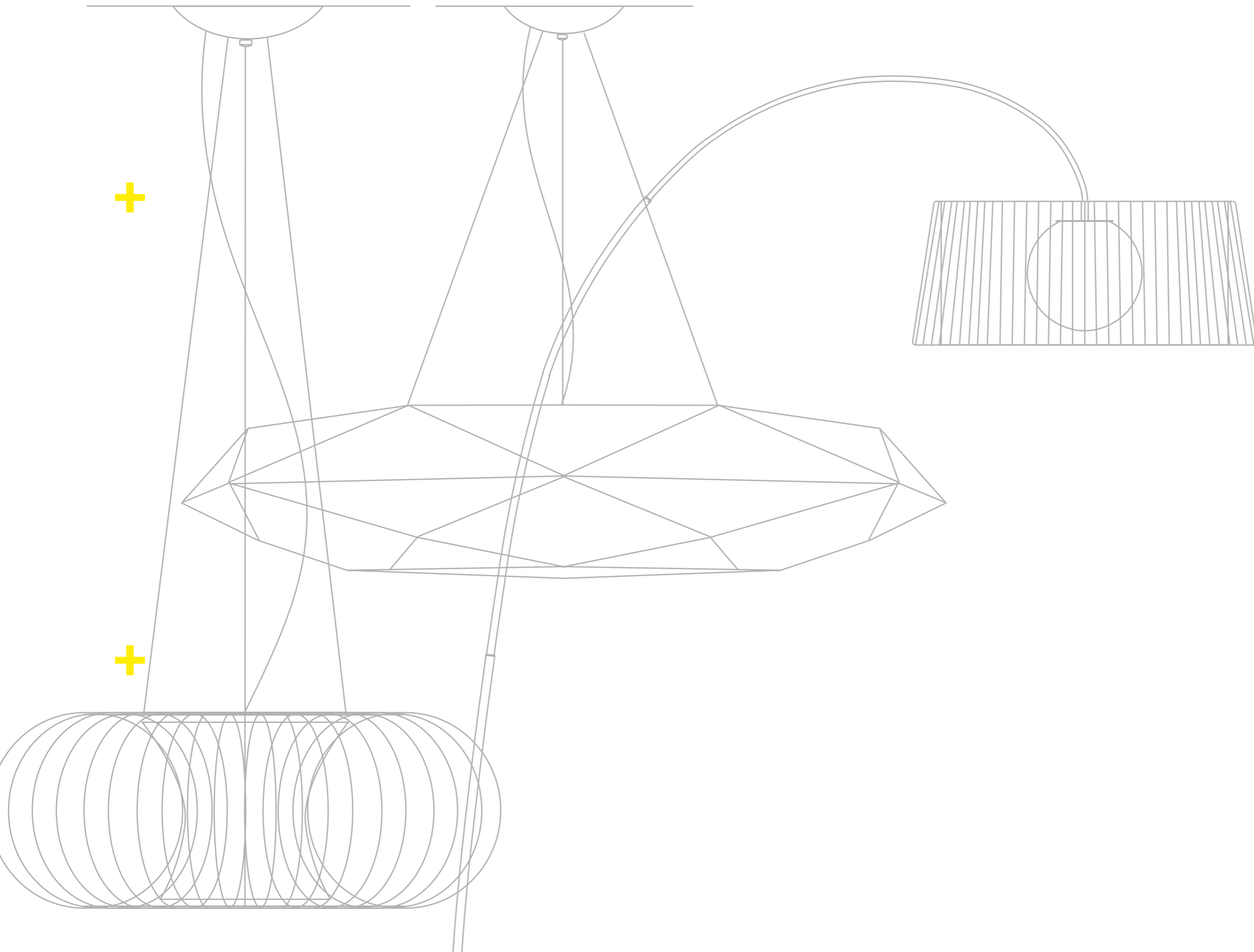

MOROSINI[®]
luce & design

+ washi





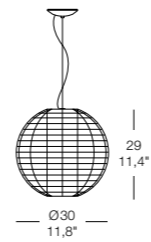

WASHI S030

1 x MAX 15W E14 fluo



LAMPADINA INCLUSA
BULB INCLUDED

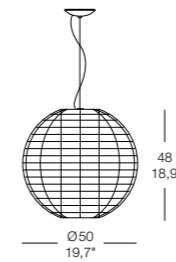

WASHI S050

1 x MAX 27W E27 PL-EL



LAMPADINA INCLUSA
BULB INCLUDED

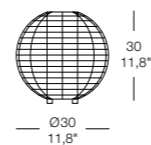

WASHI C0

1 x MAX 15W E14 fluo



LAMPADINA INCLUSA
BULB INCLUDED



WASHI TE

1 x MAX 27W E27 PL-EL



LAMPADINA INCLUSA
BULB INCLUDED

WASHI

technical
detailed lists

design **brian rasmussen**

Collezione di lampade in metallo cromato, i paralumi sono composti da nastro in tessuto elastico intrecciato nei colori: bianco, blu, moca, grigio e rosso.

Collection of lamps in chrome metal, the lampshades are composed by interwoven ribbon made of elastic fabric available in: white, blue, mocha, grey and red.

Collection de lampes en metal cromé; les diffuseurs sont réalisés en ruban élastique tressé, disponible dans les couleurs: blanc, azur, moka, gris et rouge.

Colección de lámparas en metal cromado. Las pantallas son en cinta elástica entretrejida disponible en: blanco, azul, moca, gris y rojo.

Serie aus chromiertem Metall; die Schirmen bestehen aus verflochtenem Gummiband in den Farben weiß, blau, mokka, grau und rot.

Коллекция представлена в хrome, плафоны – вплетенные ленты из эластичной ткани цвета: белый, синий, темно-коричневый, серый и красный

+ diamond







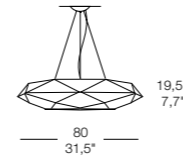





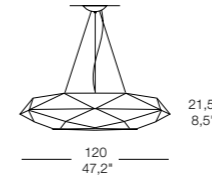

DIAMOND SO 80

3 x MAX 100W E27 inc. 
 o/or
 3 x MAX 70W E27 alo.  ENERGY SAVER
 o/or
 3 x MAX 23W
 E27 PL-EL  ENERGY SAVING

CE  IP 20





DIAMOND SO 120

3 x MAX 100W E27 inc. 
 o/or
 3 x MAX 70W E27 alo.  ENERGY SAVER
 o/or
 3 x MAX 23W
 E27 PL-EL  ENERGY SAVING

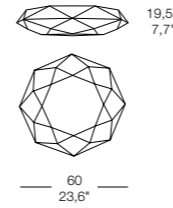
CE  IP 20





DIAMOND PP 60

2 x MAX 60W E27 inc. 
 o/or
 2 x MAX 42W E27 alo.  ENERGY SAVER
 o/or
 2 x MAX 20W
 E27 PL-EL  ENERGY SAVING

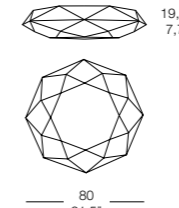
CE  IP 20





DIAMOND PP 80

3 x MAX 100W E27 inc. 
 o/or
 3 x MAX 70W E27 alo.  ENERGY SAVER
 o/or
 3 x MAX 23W
 E27 PL-EL  ENERGY SAVING

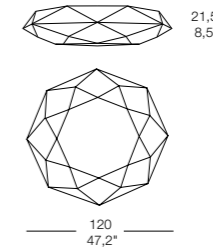
CE  IP 20



DIAMOND PP 120

3 x MAX 100W E27 inc. 
 o/or
 3 x MAX 70W E27 alo.  ENERGY SAVER
 o/or
 3 x MAX 23W
 E27 PL-EL  ENERGY SAVING

CE  IP 20

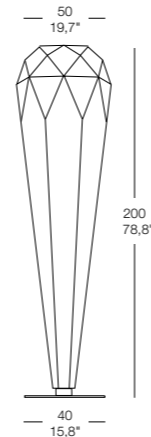

DIAMOND TE

2 x MAX 54W G5 fluo. 

CE  IP 20

DIAMOND

technical detailed lists

sandro santantonio design

Collezione di lampade con struttura metallica e rivestimento in tessuto elasticizzato lucido, sfoderabile e lavabile, disponibile nelle colorazioni bianco e argento.

Collection of lamps composed by a metal structure and a covering made of a removable and washable brilliant elastic fabric, available in white or silver colour.

Collection de lampes avec une structure métallique et un revêtement en tissu élastique brillant, amovible et lavable, available dans les couleurs blanc ou argent.

Colección de lámparas con estructura metálica y revestimiento en tejido elasticado lustroso, desfundable y lavable, disponible en color blanco o plata.

Leuchtenkollektion, Struktur aus Metall, überzogen mit einem elastischen glänzenden Stoff, abnehmbar und waschbar, verfügbar in der Farbe weiss oder silber.

Коллекция ламп с металлической конструкцией и облицовкой из эластичной блестящей ткани, которая снимается и стирается в стиральной машине, предлагается в белом и серебряном цвете.



COLORI - COLOURS

BI = bianco - white
 AG = argento - silver

+ spring





SPRING TE

MOROSINI

28 / 29



DESIGN ANDREA LAZZARI

SPRING SO 55







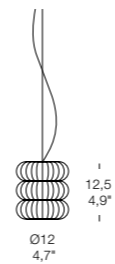
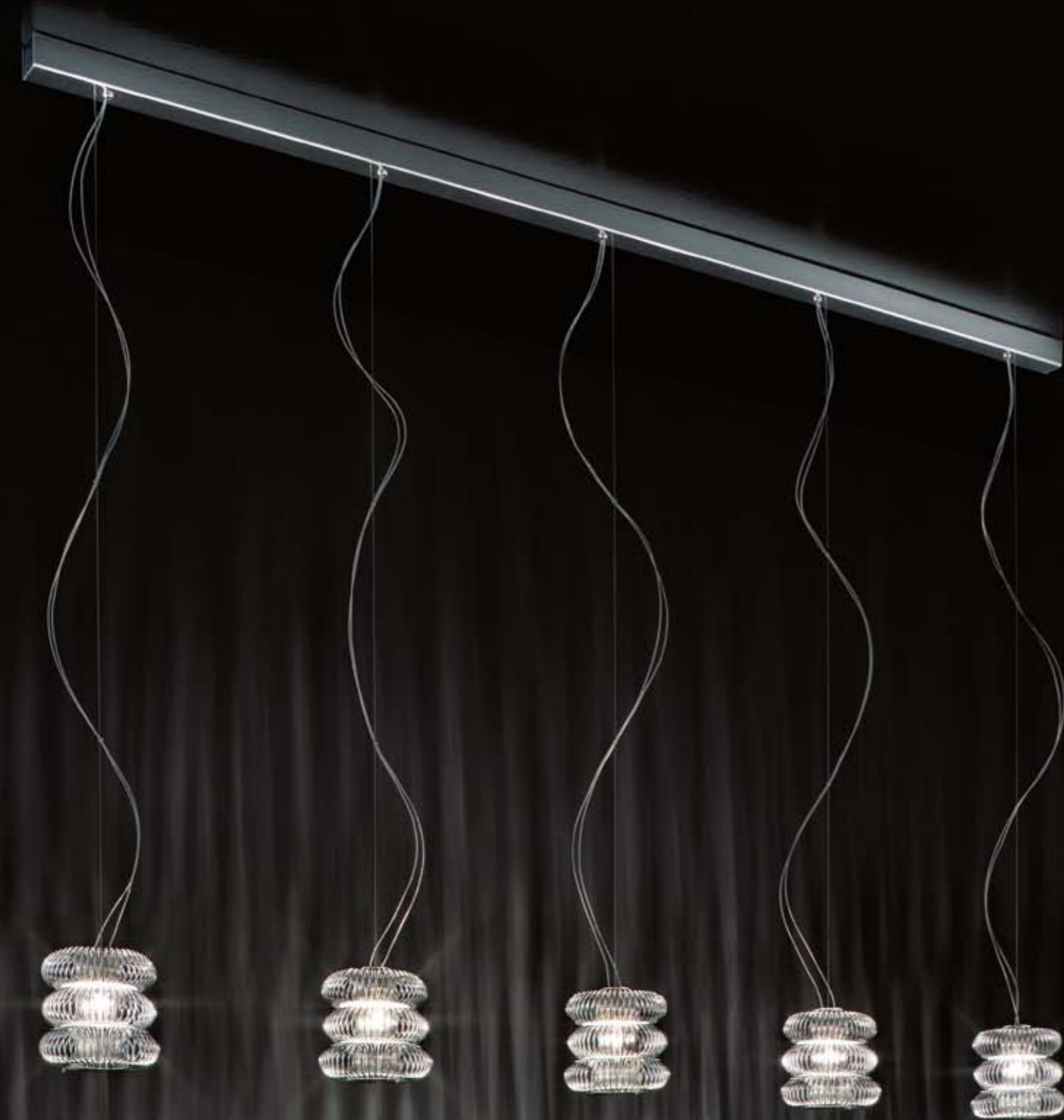

SPRING S0

1 x MAX 60W G9 halopin
 o/or
 1 x MAX 42W G9 alo. ENERGY SAVER
 CE F IP 20

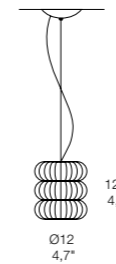

SPRING S01

1 x MAX 60W G9 halopin
 o/or
 1 x MAX 42W G9 alo. ENERGY SAVER
 CE F IP 20

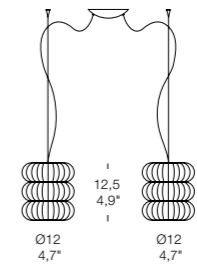

SPRING S01

2 x MAX 60W G9 halopin
 o/or
 2 x MAX 42W G9 alo. ENERGY SAVER
 CE F IP 20

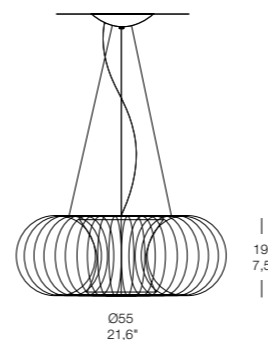

SPRING S0 55

1 x MAX 150W E27 alo./inc.
 o/or
 1 x MAX 105W E27 alo. ENERGY SAVER
 o/or
 1 x MAX 23W E27 PL-EL ENERGY SAVER
 CE F IP 20

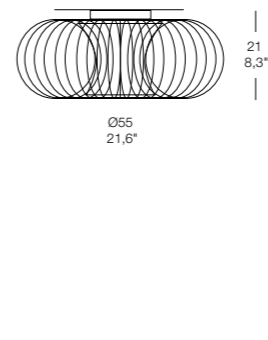

SPRING PL 55

1 x MAX 150W E27 alo./inc.
 o/or
 1 x MAX 100W E27 inc.
 o/or
 1 x MAX 105W E27 alo. ENERGY SAVER
 o/or
 1 x MAX 23W E27 PL-EL ENERGY SAVER
 CE F IP 20

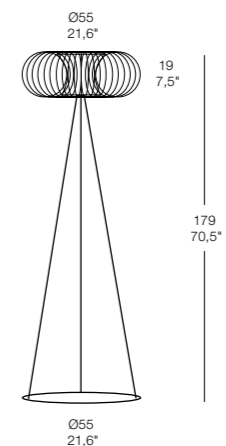

SPRING TE

1 x MAX 150W E27 alo./inc.
 o/or
 1 x MAX 140W E27 alo. ENERGY SAVER
 CE F IP 20

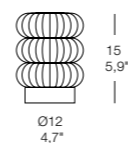

SPRING C0

1 x MAX 60W G9 halopin
 o/or
 1 x MAX 42W G9 alo. ENERGY SAVER
 CE F IP 20

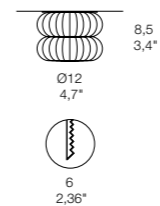

SPRING IN

1 x MAX 60W G9 halopin
 o/or
 1 x MAX 42W G9 alo. ENERGY SAVER
 CE F IP 20

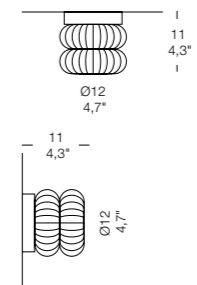

SPRING PP

1 x MAX 60W G9 halopin
 o/or
 1 x MAX 42W G9 alo. ENERGY SAVER
 CE F IP 20

SPRING

technical detailed lists

design **andrea lazzari**

Collezione di lampade in cromo, le spirali in metallo sono disponibili nelle colorazioni; cromo, bianco lucido e nero lucido, le versioni PL55 e TE sono interamente in cromo, bianco lucido e nero lucido, i vetri diffusori sono in vetro borosilicato (pyrex) trasparente e sabbiato.

Collection of lamps in chrome, the metal spirals are available in the colours: chrome, polish white and polish black, the models PL55 and TE are completely in chrome, polish white or polish black, the diffuser are in transparent or sanded pirex glass.

Collection de lampes en chrome, les spirales en metal sont available dans les couleurs: chrome, blanc brillant et noir brillant; les modèles PL55 et TE sont completement en chrome, blanc brillant ou noir brillant, les diffuseurs sont en verre pirex transparent ou sablé.

Kollektion von Leuchten in Chrom, die Spiralen aus metal sind verfügbar in den Farben: chrom, weiss glänzend und schwarz glänzend, die Modelle PL55 und TE sind komplett in chrom, weiss glänzend oder schwarz glänzend; die Diffusoren sind aus Pirex Glas transparent oder sandgestrahlt.

Colección de lámparas en cromo, las espirales en metal son disponibles en los colores: cromo, blanco lustroso y negro lustroso, los modelos PL55 y TE son totalmente en cromo, blanco lustroso y negro lustroso, los cristales difusores son en vidrio pirex transparente o arenado.

Коллекция ламп из хрома, спирали из металла предоставляются следующих цветов: хром, белый блестящий и черный блестящий, версии PL55 и TE сделаны полностью из хрома, белого блестящего и черного блестящего цвета, рассеивающие стекла сделаны из боросиликатного стекла (пирекс), прозрачного и покрытого наждачным порошком.

SYSTEM 100 B

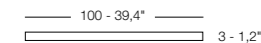

SYSTEM 150 B

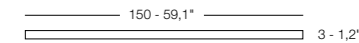

CE F IP 20

KIT SPRING PP

Opzionale: Pyrex coprilampadina
 Optional: Bulb covering in Pyrex
 Optional: Bedeckung für Leuchtmittel aus Pyrex
 Opcional: Couverture pour ampoule en Pyrex
 Opcional: Pyrex cubrebombilla
 Дополнительно: Покрытие из пирекса для лампочки

+
fog











FOG PA 30 - FOG PA 40

MOROSINI

46 / 47



DESIGN ANDREA LAZZARI E MASSIMO TONETTO



FOG TE

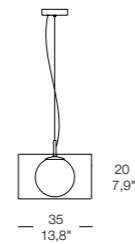

FOG PL 50



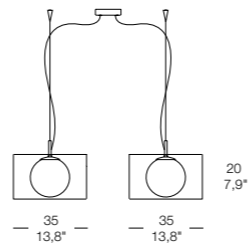

FOG SO 35

1 x MAX 75W G9 halopin 
 o/or
 1 x MAX 42W G9 alo.  ENERGY SAVER
 CE F IP 20



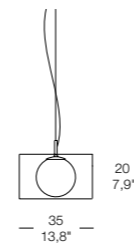

FOG SO 35/2

2 x MAX 75W G9 halopin 
 o/or
 2 x MAX 42W G9 alo.  ENERGY SAVER
 CE F IP 20



FOG SO 35 S/R

1 x MAX 75W G9 halopin 
 o/or
 1 x MAX 42W G9 alo.  ENERGY SAVER
 CE F IP 20

SYSTEM 100 B

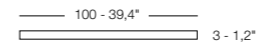

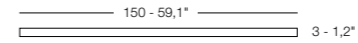

SYSTEM 150 B

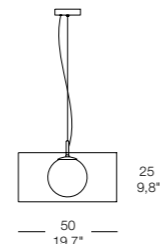

CE F IP 20



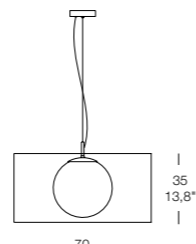

FOG SO 50

1 x MAX 100W E27 inc. 
 o/or
 1 x MAX 70W E27 alo.  ENERGY SAVER
 o/or
 1x MAX 23W E27  ENERGY SAVER
 CE F IP 20



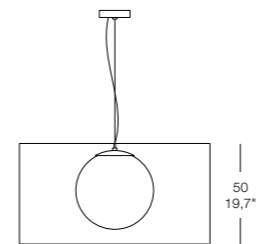

FOG SO 70

1 x MAX 150W E27 inc. 
 o/or
 1 x MAX 105W E27 alo.  ENERGY SAVER
 o/or
 1x MAX 23W E27  ENERGY SAVER
 CE F IP 20



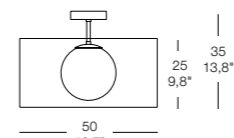

FOG SO100

1 x MAX 150W E27 inc. 
 o/or
 1 x MAX 140W E27 alo.  ENERGY SAVER
 o/or
 1x MAX 23-30W E27  ENERGY SAVER
 CE F IP 20



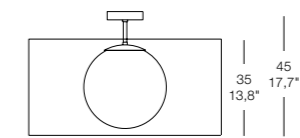

FOG PL 50

1 x MAX 100W E27 inc. 
 o/or
 1 x MAX 70W E27 alo.  ENERGY SAVER
 o/or
 1x MAX 23W E27  ENERGY SAVER
 CE F IP 20



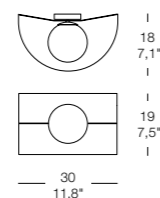

FOG PL 70

1 x MAX 150W E27 inc. 
 o/or
 1 x MAX 105W E27 alo.  ENERGY SAVER
 o/or
 1x MAX 23W E27  ENERGY SAVER
 CE F IP 20



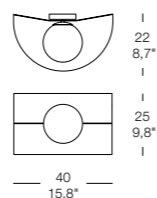

FOG PA 30

1 x MAX 60W G9 halopin 
 o/or
 1 x MAX 42W G9 alo.  ENERGY SAVER
 CE F IP 20



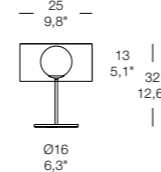

FOG PA 40

1 x MAX 75W G9 halopin 
 o/or
 1 x MAX 42W G9 alo.  ENERGY SAVER
 CE F IP 20



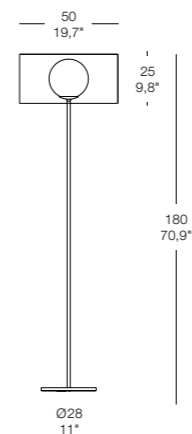

FOG CO

1 x MAX 75W G9 halopin 
 o/or
 1 x MAX 42W G9 alo.  ENERGY SAVER
 CE F IP 20



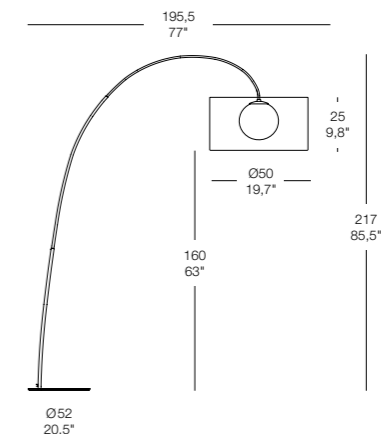

FOG TE

1 x MAX 150W E27 inc. 
 o/or
 1 x MAX 105W E27 alo.  ENERGY SAVER
 CE F IP 20



FOG TE A

1 x MAX 150W E27 inc. 
 o/or
 1 x MAX 105W E27 alo.  ENERGY SAVER
 CE F IP 20

FOG

technical detailed lists

design **andrea lazzari**
 e **massimo tonetto**

Collection of lamps in satin finished nickel metal; milk white satin finished blown glass diffuser; lampshade in white, black, red or mocha Pongé fabric. The arch floor lamp is also available with the structure in matt white and matt black.

Collection de lampes en métal nickel satiné; verre soufflé blanc lait avec finition satinée, diffuseur en tissu Pongé blanc, noir rouge ou moka. Le lampadaire à arc est aussi disponible avec la structure en blanc opaque et noir opaque.

Colección de lámparas en metal níquel satinado; cristal soplado blanco leche en acabado satinado, pantalla en tejido Pongé blanco, negro, rojo o moca. La lámpara de pie con arco está disponibles también con el amazon en los acabados blanco mate y negro mate.

Serie aus Metall Nickel satiniert, mundgeblasenes Glas milchweiß satiniert, Lampenschirm aus Pongé Stoffe weiß, schwarz, rot und mokka. Die Bogen-Stehleuchte ist auch verfügbar mit der Montur in den Ausführungen weiß matt und schwarz matt.

Коллекция светильников из сатинированного никеля; дутое матовое стекло молочного белого цвета; плафон из ткани Pongé белого, черного, красного или темно-коричневого цветов. Ножка торшера, в виде арки, может быть в матовом белом или матовом черном цветах.



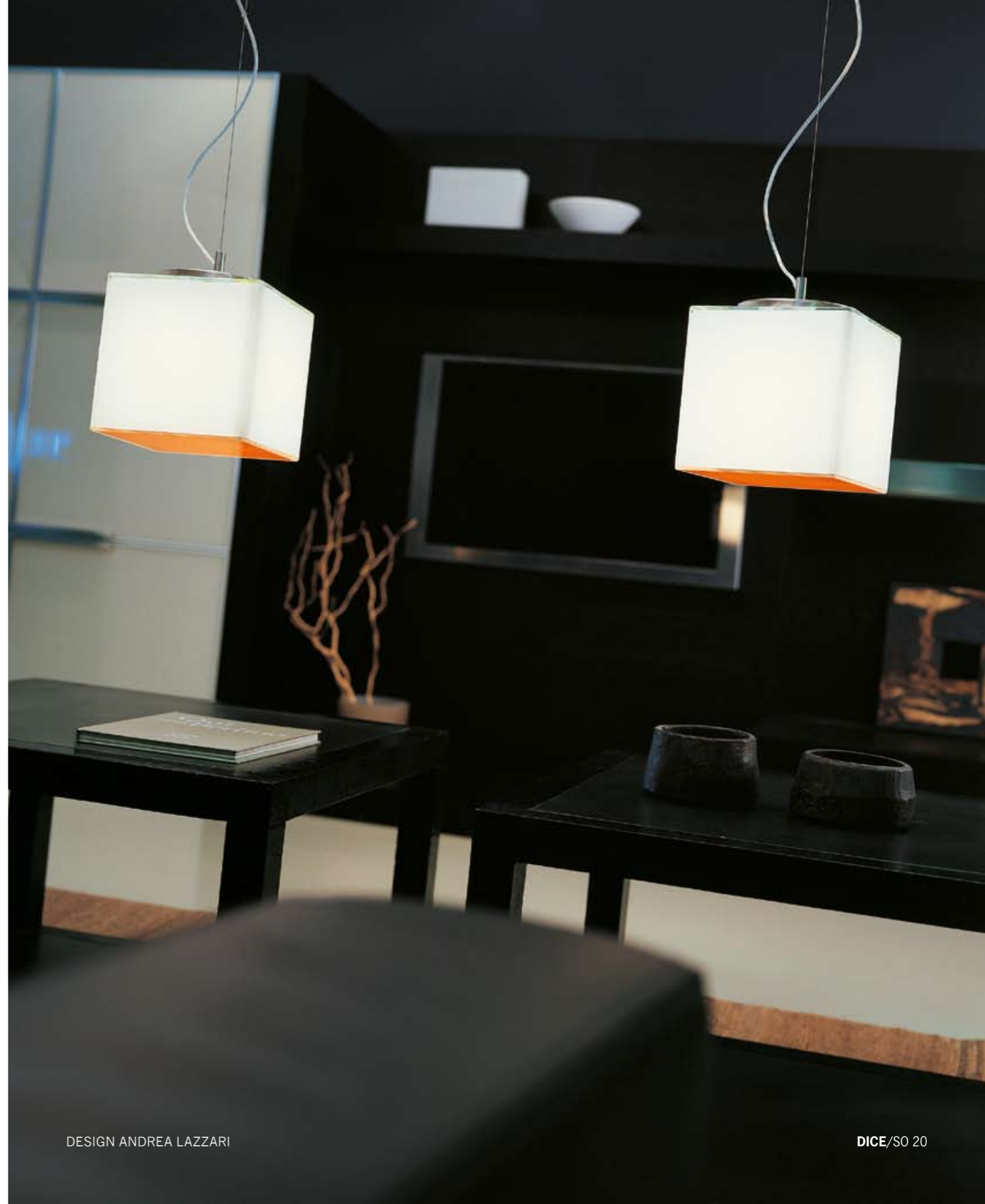
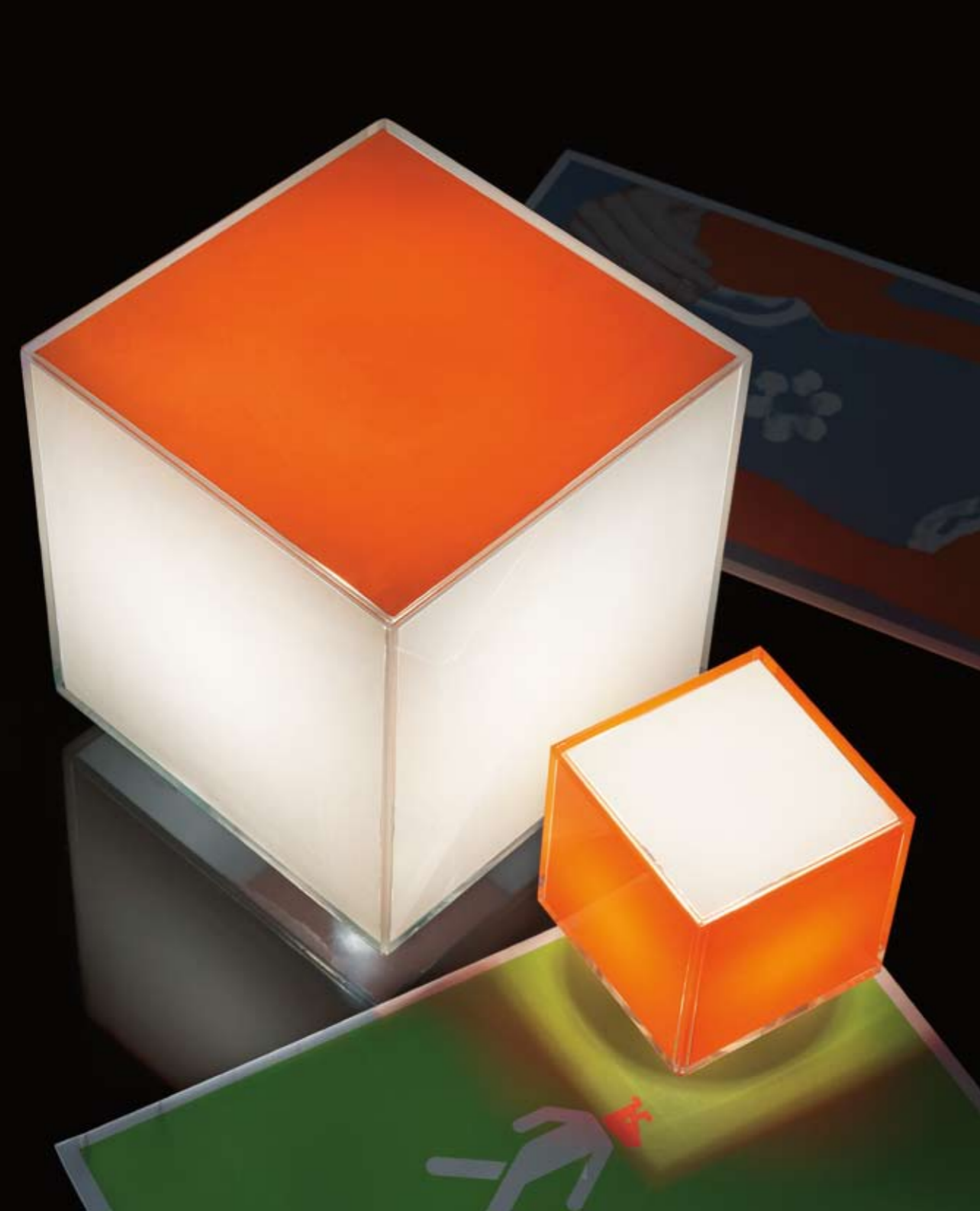

FOG CO

+ dice

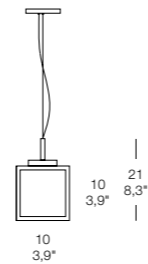



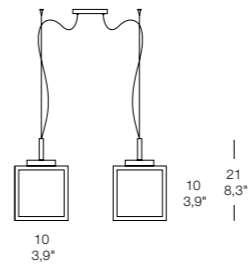

DICE/SO 10

1 x MAX 60W G9 halopin 
 o/or
 1 x MAX 42W G9 alo.  ENERGY SAVER
 o/or
 1 x MAX 9W G9 halopin  ENERGY SAVING ES
 CE F IP 40



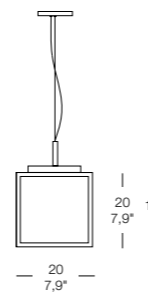

DICE/SO 10/2

2 x MAX 60W G9 halopin 
 o/or
 2 x MAX 42W G9 alo.  ENERGY SAVER
 o/or
 2 x MAX 9W G9 halopin  ENERGY SAVING ES
 CE F IP 40



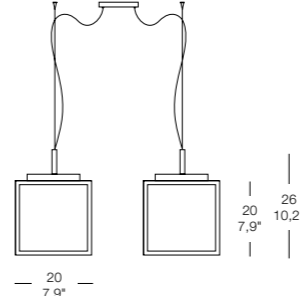

DICE/SO 20

1 x MAX 100W E27 alo./inc. 
 o/or
 1 x MAX 70W E27 alo.  ENERGY SAVER
 o/or
 1x MAX 23W E27  ENERGY SAVING ES
 CE F IP 40



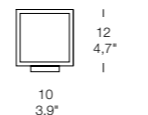

DICE/SO 20/2

2 x MAX 100W E27 alo./inc. 
 o/or
 2 x MAX 70W E27 alo.  ENERGY SAVER
 o/or
 2 x MAX 23W E27  ENERGY SAVING ES
 CE F IP 40



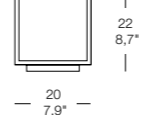

DICE/CO

1 x MAX 60W G9 halopin 
 o/or
 1 x MAX 42W G9 alo.  ENERGY SAVER
 o/or
 1 x MAX 9W G9 halopin  ENERGY SAVING ES
 CE F IP 40



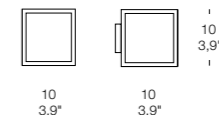

DICE/TA

1 x MAX 100W E27 alo./inc. 
 o/or
 1 x MAX 70W E27 alo.  ENERGY SAVER
 o/or
 1x MAX 23W E27  ENERGY SAVING ES
 CE F IP 40



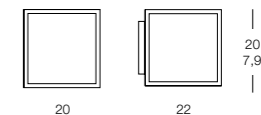

DICE/PP 10

1 x MAX 60W G9 halopin 
 o/or
 1 x MAX 42W G9 alo.  ENERGY SAVER
 o/or
 1 x MAX 9W G9 halopin  ENERGY SAVING ES
 CE F IP 40



DICE/PP 20

1 x MAX 100W E27 alo./inc. 
 o/or
 1 x MAX 70W E27 alo.  ENERGY SAVER
 o/or
 1x MAX 23W E27  ENERGY SAVING ES
 CE F IP 40

DICE
 technical
 detailed lists

design **andrea lazzari**

Collezione di lampade in metallo nichel satinato, vetro extrachiaro lucido con serigrafie bianca e arancione.

Collection of lamps in metal nickel satin finish, polished extra clear glass with screen-printings white and orange.

Collection de lampes en métal nickel satiné, verre extra clair poli avec sérigraphies en couleur blanc et orange.

Colección de lámparas en metal níquel satinado, vidrio extraclaro brillante con serigrafías en blanco y aranjado.

Serie aus Metal Nickel satiniert, extra klares Glas, poliert mit Siebdrücken weiß und orange.

Коллекция ламп из серого металла алюминия, экстрасветлого блестящего стекла с белой и оранжевой сериграфией.

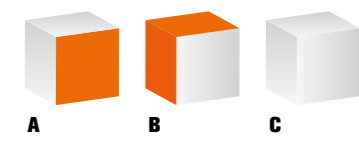



+ florian



FLORIAN/TE





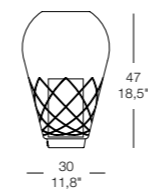

DESIGN STEFANO CAVAZZANA

FLORIAN/SO 30





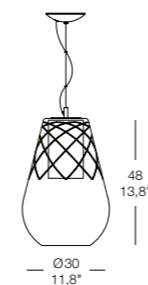

FLORIAN/TA

1 x MAX 150W E27 alo./inc. 
 o/or
 1 x MAX 105W E27 alb.  ENERGY SAVER
 o/or
 1 x 23W E27 PL-EL  ENERGY SAVING
 CE   IP 20





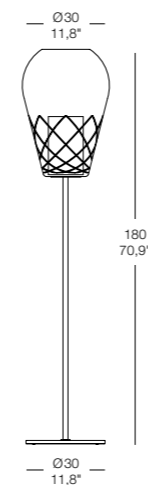

FLORIAN/SO 30

1 x MAX 150W E27 alo./inc. 
 o/or
 1 x MAX 105W E27 alb.  ENERGY SAVER
 o/or
 1x MAX 23W E27  ENERGY SAVING
 CE   IP 20



FLORIAN/TE

1 x MAX 150W E27 alo./inc. 
 o/or
 1 x MAX 140W E27 alb.  ENERGY SAVER
 CE   IP 20

FLORIAN

technical
detailed lists

design **Stefano Cavazzana**

Collezione di lampade in metallo cromato, vetro soffiato cristallo trasparente molato con vetro diffusore interno bianco latte o con cristalli Swarovsky Strass o Spectra.

Collection of lamps in chrome-metal, transparent crystal blown glass with bevelling, inside blown glass in white milk or with crystals Swarovsky Strass or Spectra.

Collection de lampes en métal chromé, verre soufflé cristal transparent avec des meulages, verre soufflé blanc lait ou avec crystals Swarovsky Strass ou Spectra.

Colección de lámparas en metal cromado, cristal soplado transparente con biselados, con cristal difusor interior blanco leche o con cristales Swarovsky Strass o Spectra.

Serie in Chrom, mundgeblasenes Kristallglas mit Schleiferei, mundgeblasenes Glas satiniert in den Farben milchweiß oder mit Crystal Swarovsky Strass oder Spectra.

Коллекция ламп из хромированного металла, выдувного прозрачного стекла с хрустальной шлифовкой, с внутренним стеклянным отражателем молочно-белого цвета или с хрустальными Swarovsky Strass или Spectra.

+ ribbon





RIBBON 40 S02

MOROSINI



DESIGN ANDREA LAZZARI

RIBBON TE



RIBBON TE A



DESIGN ANDREA LAZZARI



RIBBON 80 PL

MOROSINI



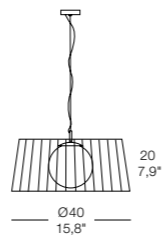

DESIGN ANDREA LAZZARI

RIBBON PA 40



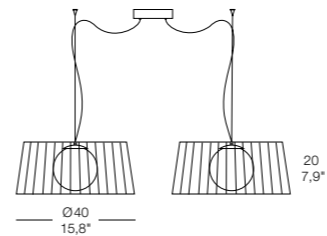

RIBBON SO 40

1 x MAX 75W G9 halopin 
 o/or
 1 x MAX 42W G9 alo.  ENERGY SAVER
 CE F IP 20





RIBBON SO2 40

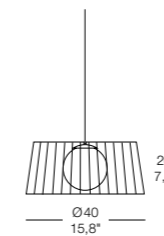

2 x MAX 75W G9 halopin 
 o/or
 2 x MAX 42W G9 alo.  ENERGY SAVER
 CE F IP 20





RIBBON SO S/R

1 x MAX 75W G9 halopin 
 o/or
 1 x MAX 42W G9 alo.  ENERGY SAVER
 CE F IP 20

SYSTEM 100 B

100 - 39,4" 
 3 - 1,2" 

SYSTEM 150 B

150 - 59,1" 
 3 - 1,2" 

CE F IP 20

RIBBON

technical detailed lists

design **andrea lazzari**

Collezione di lampade in metallo nichel satinato, vetro soffiato bianco latte satinato, paralume composto da nastro setato colore bianco, mocha, grigio e nero. La versione da terra ad arco è disponibile anche con montatura bianco opaco e nero opaco.

Collection of lamps in satin nickel metal, matt white or matt black structure; milk white satin finished blown glass diffuser; lampshade is made of a silky ribbon available in the following colours: white, mocha, grey and black. The arch floor lamp is also available in matt white or matt black metal.

Collection de lampes en métal nickel satiné, verre soufflé blanc lait, finition satinée, diffuseur en ruban de soie disponible en: blanc, mocha, gris y noir. Le lampadaire à arc est aussi disponible avec la structure en blanc opaque et noir opaque.



Colección de lámparas en metal níquel satinado, cristal soplado blanco leche, acabado satinado, pantalla en cinta sedosa disponible en: blanco, mocha, gris y negro. La lámpara de pie con arco está disponibles también en los acabados blanco mate y negro mate.

Serie aus Metall Nickel satiniert, mundgeblasenes Glas, milchweiß satiniert, der Lampenschirm besteht aus Seidebänder, verfügbar in den Farben weiß, mokka, grau und schwarz. Die Bogen-Stehleuchte ist auch verfügbar mit der Montur in den Ausführungen weiß matt und schwarz matt.

Основание - матовый никель, матовый белый или матовый черный цвета; дутое матовое стекло молочного белого цвета; Абажур из шелковых лент может быть в белом, темно-коричневом, сером и черном цветах. Ножка торшера, в виде арки, может быть в матовом белом или матовом черном цветах.



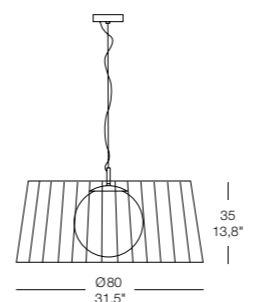

RIBBON SO 60

1 x MAX 100W E27 inc. 
 o/or
 1 x MAX 70W E27 alo.  ENERGY SAVER
 o/or
 1x MAX 23W E27  ENERGY SAVER
 CE F IP 20



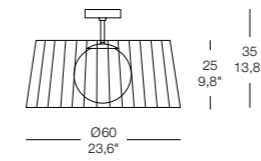

RIBBON SO 80

1 x MAX 150W E27 inc. 
 o/or
 1 x MAX 105W E27 alo.  ENERGY SAVER
 o/or
 1x MAX 23-30W E27  ENERGY SAVER
 CE F IP 20



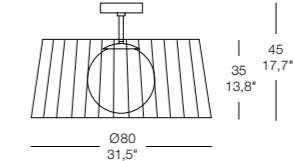

RIBBON PL 60

1 x MAX 100W E27 inc. 
 o/or
 1 x MAX 70W E27 alo.  ENERGY SAVER
 o/or
 1x MAX 23W E27  ENERGY SAVER
 CE F IP 20



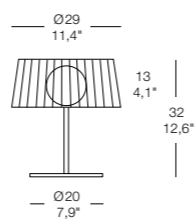

RIBBON PL 80

1 x MAX 150W E27 inc. 
 o/or
 1 x MAX 105W E27 alo.  ENERGY SAVER
 o/or
 1x MAX 23W E27  ENERGY SAVER
 CE F IP 20



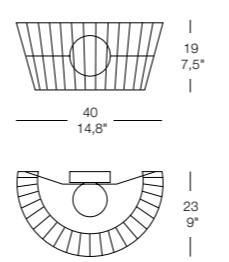

RIBBON CO

1 x MAX 75W G9 halopin 
 o/or
 1 x MAX 42W G9 alo.  ENERGY SAVER
 CE F IP 20



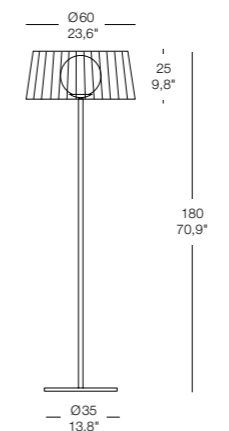

RIBBON PA 40

1 x MAX 75W G9 halopin 
 o/or
 1 x MAX 42W G9 alo.  ENERGY SAVER
 CE F IP 20



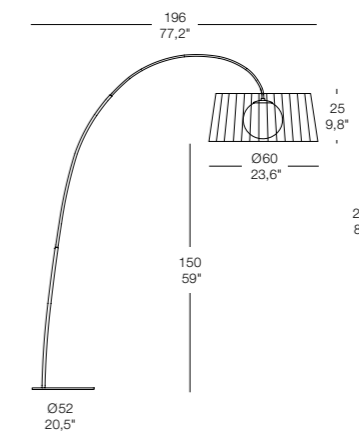

RIBBON TE

1 x MAX 150W E27 inc. 
 o/or
 1 x MAX 105W E27 alo.  ENERGY SAVER
 CE F IP 20



RIBBON TE A

1 x MAX 150W E27 inc. 
 o/or
 1 x MAX 105W E27 alo.  ENERGY SAVER
 CE F IP 20



+ flat/q
flat/r
flat/pp

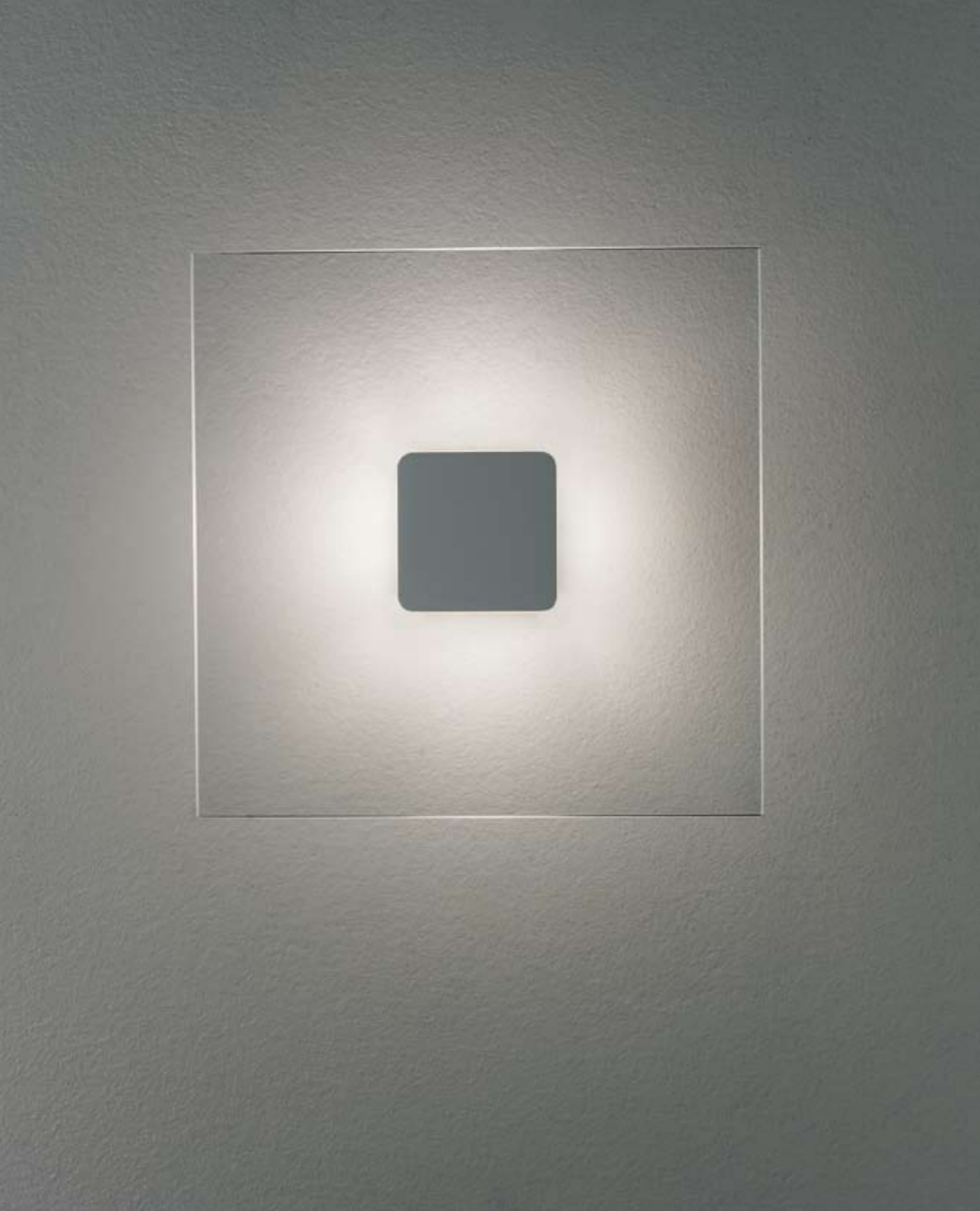

BS

GM

AR





BS



SK



AR





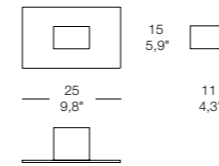

FLAT/R

1 x MAX 60W G9 halopin 
 o/or
 1 x MAX 42W G9 alo.  ENERGY SAVER
 CE   IP 40

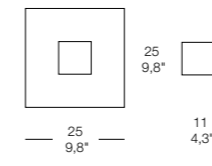

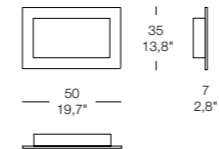

FLAT/Q

1 x MAX 60W G9 halopin 
 o/or
 1 x MAX 42W G9 alo.  ENERGY SAVER
 CE   IP 40





FLAT/PP 35 E

2 x MAX 24W E27
 2G11 Fluo  ENERGY SAVER
 CE   IP 40 ADA

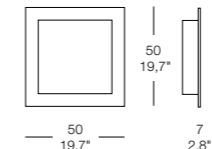
E-ballast elettronico/Electronic ballast



FLAT/PP 50 E

2 x MAX 24W E27
 2G11 Fluo  ENERGY SAVER
 CE   IP 40 ADA

E-ballast elettronico/Electronic ballast

FLAT/Q/R/PP

technical
detailed lists

design **andrea lazzari**

Collezione di lampade da parete e soffitto con diffusore in vetro extrachiaro trasparente con serigrafia nella parte centrale di colore bianco, arancione e grigio metallizzato.

Collection of wall-ceiling lamps, diffuser in extra clear glass with screen printing in the central part in white, orange or metallized grey.

The versions PP35 and PP50 are available only in the colours white, orange and mirror.

Collection de lampes applique-plafonnier avec diffuseur en verre extra-clair sérigraphié dans la partie centrale en couleur blanc, orange ou gris métallisé.

Les versions PP35 et PP50 sont available seulement dans les couleurs: blanc, orange et miroir.

Colección de lámparas de pared y de techo con difusor de vidrio extraclaro transparente con serigrafía en el centro de colores blanco, anaranjado y gris metalizado. Las versiones PP35 y PP50 son disponibles solo en los colores: blanco, anaranjado y espejo.

Serie von Wand-Decken Leuchten, Schirm aus extraklarem Glas mit Siebdruck in der Mitte in den Farben weiß, orange oder grau metallisiert. Die Versionen PP35 und PP50 sind verfügbar nur in den Farben: weiss, orange und spiegel.

Коллекция настенных и потолочных ламп с отражателем из прозрачного экстрасветлого стекла, с сериграфированием в середине белого цвета, оранжевого цвета и металлического серово цвета. Версии PP35 и PP50 доступны только в цветах: белый, оранжевый и зеркальный.

+
giglio



GIGLIO/S02

MOROSINI





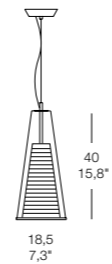

DESIGN ANDREA LAZZARI E MASSIMO TONETTO

GIGLIO/PA





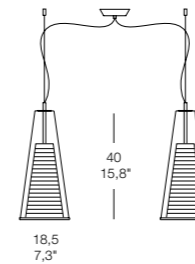

GIGLIO/SO

1 x MAX 150W E27 alo./inc. 
 o/or
 1 x MAX 105W E27 alo.  ENERGY SAVER
 o/or
 1x MAX 23W E27  ENERGY SAVING
 CE   IP 20





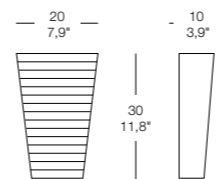

GIGLIO/SO2

2 x MAX 150W E27 alo./inc. 
 o/or
 2 x MAX 105W E27 alo.  ENERGY SAVER
 o/or
 2x MAX 23W E27  ENERGY SAVING
 CE   IP 20





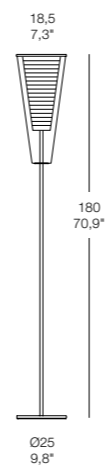

GIGLIO/PA

1 x MAX 100W E27 alo./inc. 
 o/or
 1 x MAX 70W E27 alo.  ENERGY SAVER
 o/or
 1x MAX 20W E27  ENERGY SAVING
 CE   IP 20



GIGLIO/TE

1 x MAX 150W E27 alo./inc. 
 o/or
 1 x MAX 140W E27 alo.  ENERGY SAVER
 CE   IP 20

GIGLIO

technical detailed lists

design **andrea lazzari**
 e **massimo tonetto**

Collezione di lampade in metallo cromato, vetro soffiato cristallo trasparente e vetro soffiato bianco latte con molature cristallo, finitura satinata.

Collection of lamps in chrome-metal, blown crystal transparent glass and milk white blown glass with bevelling in crystal, satin finish.

Collection de lampes en métal chromé, verre soufflé cristal transparent et verre soufflé blanc lait avec des meulages en cristal, finition satinée.

Colección de lámparas en metal cromado, cristal soplado transparente y cristal soplado blanco leche con biselados cristal, acabado satinado.

Serie in Chrom, mundgeblasenes Kristallglas und mundgeblasenes milchweiße Glas mit Kristallchliff, satiniert.

Коллекция ламп из хромированного металла, выдувного прозрачного стекла молочно-белого цвета с хрустальной шлифовкой и сатирированной отделкой.

Lampada da parete in metallo cromato, vetro extrachiaro serigrafato bianco con finitura lucida.

Wall lamp in chrome-metal, extra clear glass with white screen printing, satin finish.

Applique en métal chromé, verre extra-clair sérigraphié blanc, finition satinée.

Aplique en metal cromado, cristal extraclaro serigrafado blanco, acabado satinado.

Wandleuchter in Chrom, Glas extraklar mit Siebdruck weiß, satiniert.

Настенная лампа из хромированного металла, сериграфированное экстрасветлое стекло с блестящей отделкой.

+ round





ROUND/SO 35

MOROSINI

90 / 91



DESIGN ANDREA LAZZARI E MASSIMO TONETTO

ROUND/SO 15





ROUND/PP

MOROSINI

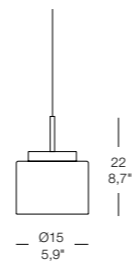

ROUND/SO 15 S

1 x MAX 60W G9 halopin
 o/or
 1 x MAX 42W G9 alo.

CE F IP 20

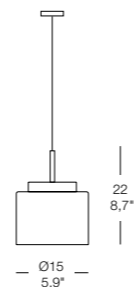

ROUND/SO 15

1 x MAX 60W G9 halopin
 o/or
 1 x MAX 42W G9 alo.

CE F IP 20

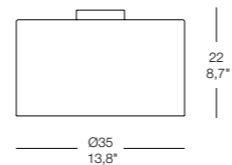

ROUND/PL

3 x MAX 60W E27 inc.
 o/or
 3 x MAX 42W E27 alo.
 o/or
 3 x MAX 11W E27

CE F IP 20

SYSTEM 100 A

100 - 39,4"
 3 - 1,2"

SYSTEM 150 A

150 - 59,1"
 3 - 1,2"

CE F IP 20

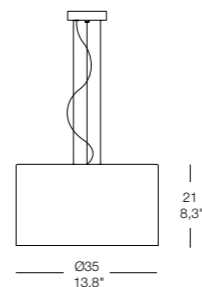

ROUND/SO 35

3 x MAX 60W E27 inc.
 o/or
 3 x MAX 42W E27 alo.
 o/or
 3 x MAX 11W E27

CE F IP 20

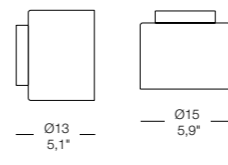

ROUND/PP

1 x MAX 60W G9 halopin
 o/or
 1 x MAX 42W G9 alo.

CE F IP 20

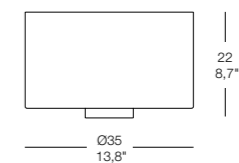

ROUND/TA

3 x MAX 60W E27 inc.
 o/or
 3 x MAX 42W E27 alo.
 o/or
 3 x MAX 11W E27

CE F IP 20

ROUND

technical detailed lists

design **Andrea Lazzari**

Collezione di lampade in metallo cromato o nichel satinato, vetro soffiato bianco latte satinato o rosso satinato. Disponibile con lente in vetro satinato.

Collection of lamps in chrome-metal or satin finished nickel, blown glass milk white or red, satin finish. Available with satin finished glass lens.

Collection de lampes en métal chromé ou nickel satiné, verre soufflé blanc lait ou rouge, finition satinée. Disponible avec lentille en verre satiné.

Colección de lámparas en metal cromado o níquel satinado, cristal soplado blanco leche o rojo acabado satinado. Disponible con lente en cristal satinado.

Serie in Chrom oder Nickel satiniert, mundgeblasenes Glas milchweiß oder rot, satiniert. Auch verfügbar mit Linse aus satiniertem Glas.

Коллекция ламп из хромированного металла или сатинированного никеля, выдувное стекло молочно-белого или красного сатинированного цвета. Предоставляется с линзой из сатинированного стекла.

ROUND GLASS

Lente in vetro satinata.
 Satin finish glass lens.
 Lentille en verre satiné.
 Lente en cristal satinado.
 Schirm aus satiniertem Glas.
 Сатинированная стеклянная линза.

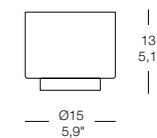

ROUND/CO

1 x MAX 60W G9 halopin
 o/or
 1 x MAX 42W G9 alo.



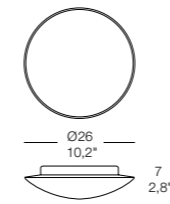

CE F IP 20

+ alaska







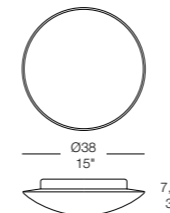

ALASKA/PP 26

1 x MAX 60W E27 inc. 
 o/or
 1 x MAX 42W E27 alo. Sfera 
 o/or
 1x MAX 15W E27  

CE  IP 40 ADA





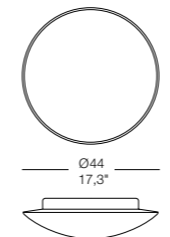

ALASKA/PP 38

2 x MAX 60W E27 inc. 
 o/or
 2 x MAX 42W E27 alo. Sfera 
 o/or
 2 x MAX 15W E27  

CE  IP 40 ADA



ALASKA/PP 44

3 x MAX 60W E27 inc. 
 o/or
 3 x MAX 42W E27 alo. Sfera 
 o/or
 3 x MAX 15W E27  

CE  IP 40 ADA

ALASKA

technical
detailed lists

design **ufficio stile**

Collezione di lampade da parete e soffitto in vetro soffiato bianco latte lucido con bordo in cristallo trasparente.

Collection of wall-ceiling lamps, milkwhite blown glass polished finish with transparent crystal edge.

Collection de lampes applique-plafonnier, diffuseur en verre soufflé blanc lait finition brillante avec bord en cristal transparent.

Colección de lámparas de pared y de techo, de vidrio soplado blanco leche brillante con borde de cristal transparente.

Serie von Wand-Decken Leuchten, Schirm aus mundgeblasenem glänzenden milchweißen Glas mit Bord aus Klar-kristallglas.

Коллекция настенных и потолочных ламп из молочно-белого блестящего выдувного стекла с кромкой из прозрачного хрустала





+ cool





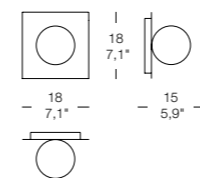
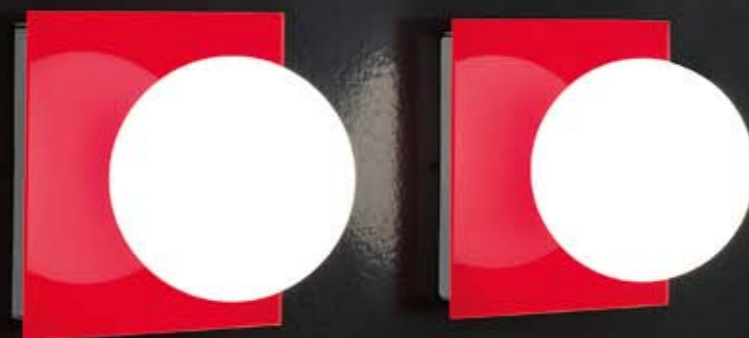

COOL/PA 1

1 x MAX 60W G9 halopin
 o/or
 1 x MAX 42W G9 alo. ENERGY SAVER
 CE IP 40

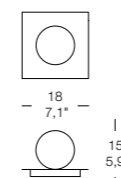

COOL/CO

1 x MAX 60W G9 halopin
 o/or
 1 x MAX 42W G9 alo. ENERGY SAVER
 CE IP 40

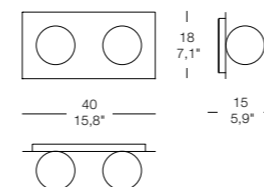

COOL/PA 2

2 x MAX 60W G9 halopin
 o/or
 2 x MAX 42W G9 alo. ENERGY SAVER
 CE IP 40

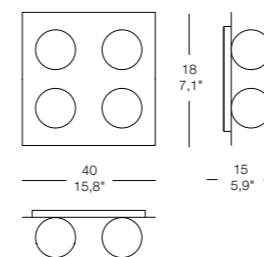

COOL/PL

4 x MAX 60W G9 halopin
 o/or
 4 x MAX 42W G9 alo. ENERGY SAVER
 CE IP 40

COOL

technical detailed lists

design **andrea lazzari**

Collezione di lampade in vetro nero lucido, rosso lucido e specchio, vetro soffiato bianco latte con finitura satinata.

Collection of lamps in glass in colours polished black, red or mirror, milk white blown glass, satin finish.

Collection de lampes avec diffuseur en verre poli noir, rouge ou miroir, verre soufflé blanc lait, finition satinée.

Colección de lámparas en vidrio de colores lucido negro, rojo o espejo, cristal soplado blanco leche, acabado satinado.

Serie mit Schirm aus Glas in den Farben schwarz, rot oder spiegel, mundgeblasenes milchweißes Glas, satiniert.

Коллекция ламп из стекла черного блестящего, красного блестящего цвета и зеркала, выдувного стекла молочно-белого цвета с сатирированной отделкой.



+ asia





ASIA/PA



ASIA/PL

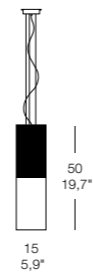

ASIA/SO

1 x MAX 150W E27 alo./inc.

o/or

1 x MAX 105W E27 alo.

o/or

1 x 23W E27 PL-EL

+

1 x MAX 50W E27 Gu10

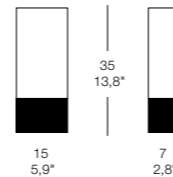

ASIA/PA

2 x MAX 60W G9 halopin

o/or

2 x MAX 42W G9 alo.

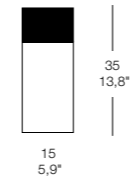

ASIA/PL

1 x MAX 150W E27 alo./inc.

o/or

1 x MAX 105W E27 alo.

o/or

1 x 23W E27 PL-EL

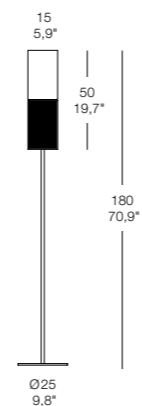

ASIA/TE

1 x MAX 150W E27 alo./inc.

o/or

1 x MAX 140W E27 alo.

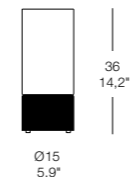

ASIA/CO

1 x MAX 150W E27 alo./inc.

o/or

1 x MAX 105W E27 alo.

o/or

1 x 23W E27 PL-EL

ASIA

technical
detailed lists

design **andrea lazzari**
e **massimo tonetto**

Collezione di lampade in metallo cromato, con doppio vetro soffiato bianco e nero, finitura lucida.

Collection of lamps in chrome-metal, with double white and black blown glass, polished finish.

Collection de lampes en métal chromé, avec double verre soufflé blanc et noire, finition brillante.

Colección de lámparas en metal cromado, con doble cristal soplado blanco y negro, acabado lucido.

Serie aus Metall Chrom mit doppeltem mundgeblasenen Glas weiß und schwarz mit glänzender Ausführung.

Коллекция ламп из хромированного металла, с двойным выдувным белым и черным стеклом и блестящей отделкой.

+ wave



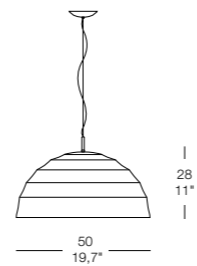

WAVE/SO 50

1 x MAX 150W E27 inc.

o/or

1 x MAX 105W E27 alb. ENERGY SAVER

o/or

1 x 21W E27 PL-EL ENERGY SAVING

CE IP 20

WAVE

technical
detailed lists

design **ufficio stile**

Collezione di sospensioni in metallo cromato o nichel satinato, vetro pressato disponibile nei colori bianco latte satinato, rosso satinato e grigio metallizzato.

Collection of suspensions in chrome-metal or satin finished nickel, pressed glass available in satin finished milk white, satin finished red or grey aluminium.

Collection de suspensions en métal chromé ou nickel satiné, verre pressé disponible en blanc lait satiné, rouge satiné ou gris aluminium.

Colección de suspensiones en metal cromado o niquel satinado, cristal prensado disponible en blanco leche satinado, rojo satinado o gris aluminio.

Serie von Hängelampen in Chrom oder Nickel satiniert, gepresst Glas erhältlich in den Farben milchweiß satiniert, Rot satiniert oder aluminium grau.

Коллекция подвесок из хромированного металла или сатирированного никеля, прессованное стекло предоставляется молочно-белого сатирированного цвета, красного сатирированного и серого металлизированного.



+ club

CLUB

technical
detailed lists

design **andrea lazzari**
e **massimo tonetto**

Collezione di lampade in legno Wengé, Zebrano, vetro extrachiaro serigrafato bianco con finitura satinata.

Collection of lamps in Wengé or Zebrano wood; extra clear glass with white screen printing, satin finish.

Collection de lampes en bois Wengé ou Zebrano, verre extra-clair sérigraphié blanc, finition satinée.

Colección de lámparas en madera Wengé o Zebrano, cristal extraclaro serigrafado blanco, acabado satinado.

Serie aus Holz Wengé oder Zebrano, extraklares Glas mit weißen Siebdruck, satiniert.

Коллекция ламп из древесины Венге, зебрано, с экстрасветлым стеклом с белой сериграфией с сатирированной отделкой.

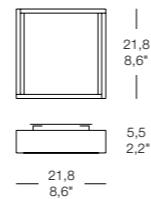

CLUB 20/PP

2 x MAX 40W G9 halopin

o/or

2 x MAX 33W G9 alo. ENERGY SAVER

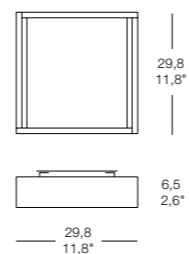

CLUB 30/PP

4 x MAX 40W G9 halopin

o/or

4 x MAX 33W G9 alo. ENERGY SAVER

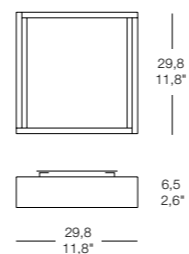

CLUB 30/PP E

2 x MAX 18W

2G11 fluo. ENERGY SAVER



Ballast elettronico / electronic ballast
Elektronische Vorschaltgerate
Ballast électronique / Ballast electrónico
Электронный балласт

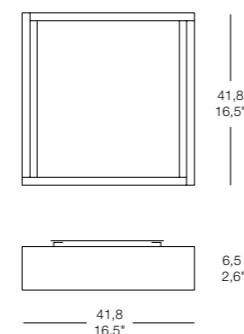

CLUB 40/PP

4 x MAX 60W G9 halopin

o/or

4 x MAX 42W G9 alo. ENERGY SAVER

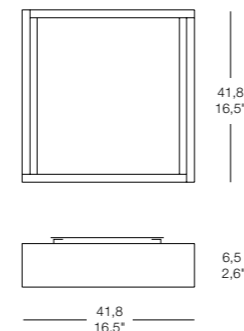

CLUB 40/PP E

2 x MAX 24W 2G11

fluo. ENERGY SAVER



Ballast elettronico / electronic ballast
Elektronische Vorschaltgerate
Ballast électronique / Ballast electrónico
Электронный балласт

+ dress r





select 50
2000
HIGH IN
CYBER



DRESS R/TA

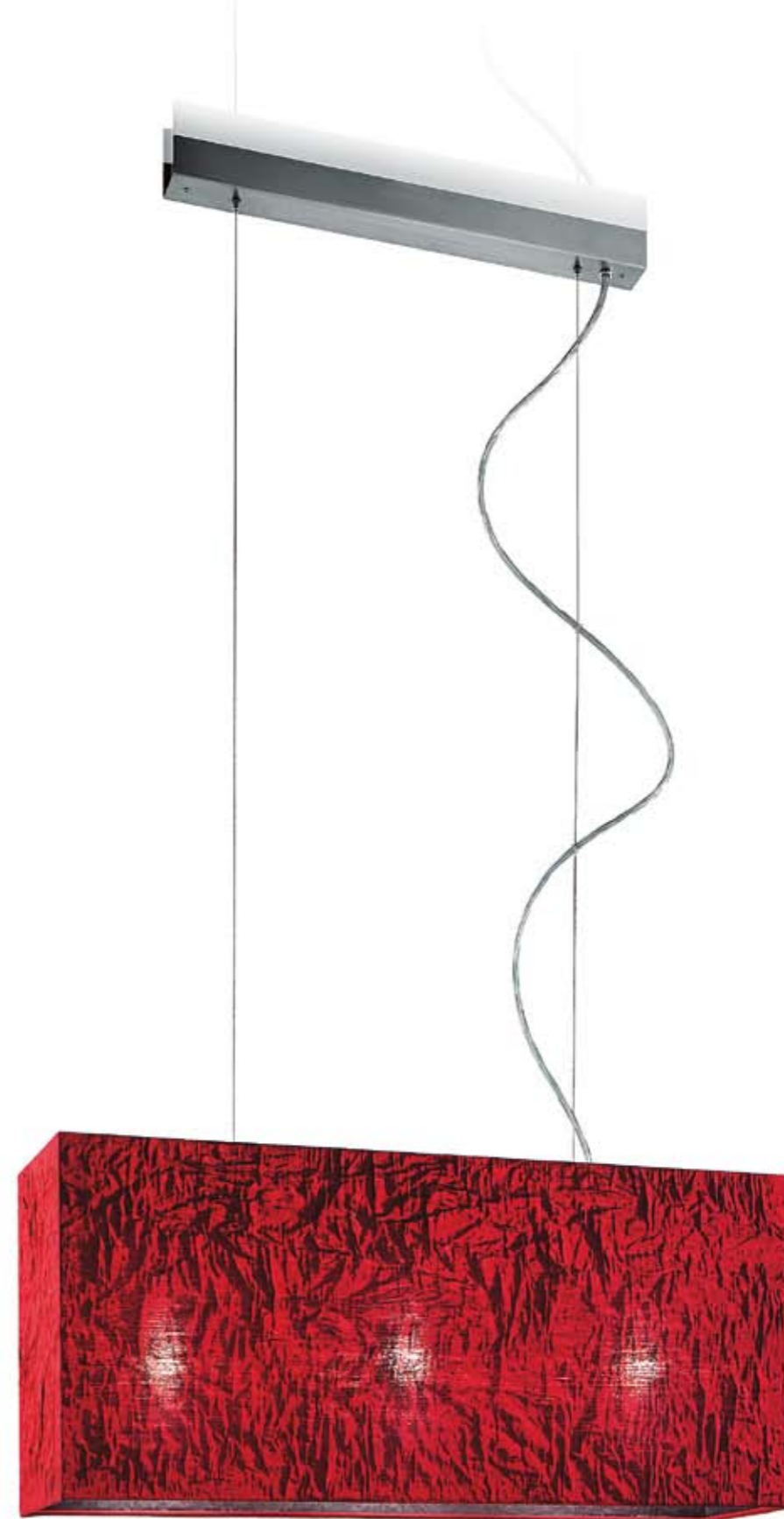

DESIGN ANDREA LAZZARI





DRESS R

technical detailed lists

design **andrea lazzari**

Collezione di lampade in acciaio inox satinato, diffusore in tessuto metallico, colore silver, rosso e avorio.

Collection of lamps in satin finished stainless steel, metal fabric diffuser in the colours silver, red and ivory.

Collection de lampes en acier inox satiné, diffuseur en tissu métallique dans les couleurs silver, rouge et ivoire.

Colección de lámparas en acero inox satinado, difusor en tejido metálico, color silver, rojo y marfil.

Serie in Stahl Inox satiniert, Schirm aus Metallgewebe in den Farben silver, rot und elfenbein.

Коллекция ламп из сатинированной нержавеющей стали, отражатель из металлической ткани серебряного цвета, красного цвета и цвета слоновой кости.

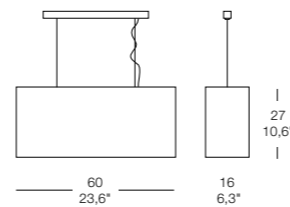

DRESS R/SO 60

- 3 x MAX 60W E27 inc.
 - o/or
 - 3 x MAX 42W E27 alo.
 - o/or
 - 3 x 20W E27 PL-EL
- CE IP 20

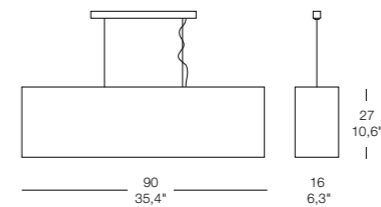

DRESS R/SO 90

- 4 x MAX 60W E27 inc.
 - o/or
 - 4 x MAX 42W E27 alo.
 - o/or
 - 4 x 20W E27 PL-EL
- CE IP 20

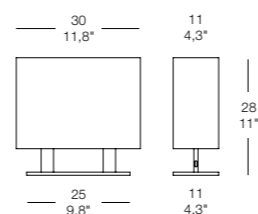

DRESS R/CO

- 2 x MAX 40W E14 inc.
 - o/or
 - 2 x MAX 28W E14 alo.
 - o/or
 - 2 x 11W E14 fluo
- CE IP 20

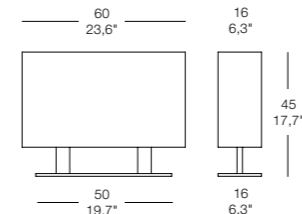

DRESS R/TA

- 3 x MAX 60W E27 inc.
 - o/or
 - 3 x MAX 42W E27 alo.
 - o/or
 - 3 x 20W E27 PL-EL
- CE IP 20

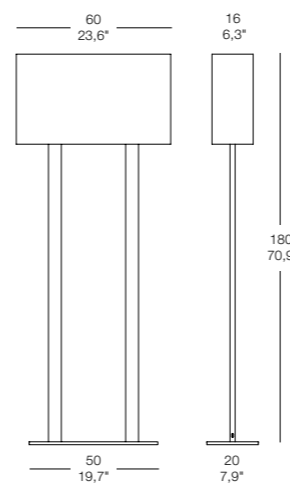

DRESS R/TE

- 3 x MAX 60W E27 inc.
 - o/or
 - 3 x MAX 42W E27 alo.
- CE IP 20

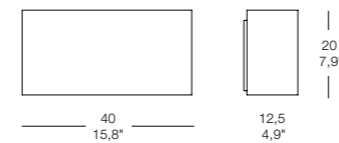

DRESS R/PA 40

- 2 x MAX 60W E27 inc.
 - o/or
 - 2 x MAX 42W E27 alo.
 - o/or
 - 2 x 23W E27 PL-EL
- CE IP 20



+ **broadway**





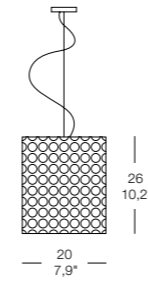

BROADWAY/SO 20

- 1 x MAX 100W E27 inc.
 - o/or
 - 1 x MAX 70W E27 alo.
 - o/or
 - 1 x 23W E27 PL-EL
- CE IP 20

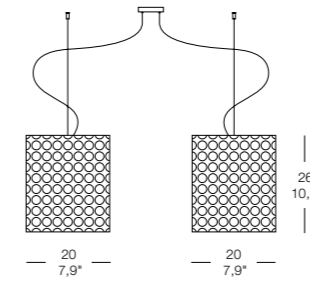

BROADWAY/SO 20/2

- 2 x MAX 100W E27 inc.
 - o/or
 - 1 x MAX 70W E27 alo.
 - o/or
 - 2 x 23W E27 PL-EL
- CE IP 20

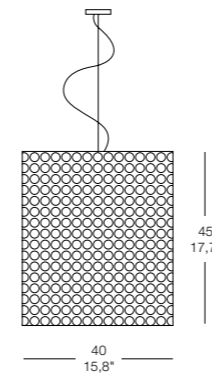

BROADWAY/SO 40

- 4 x MAX 60W E27 inc.
 - o/or
 - 4 x MAX 42W E27 alo.
 - o/or
 - 4 x 20W E27 PL-EL
- CE IP 20

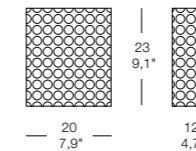

BROADWAY/PA

- 1 x MAX 100W E27 inc.
 - o/or
 - 1 x MAX 70W E27 alo.
 - o/or
 - 1 x 20W E27 PL-EL
- CE IP 20

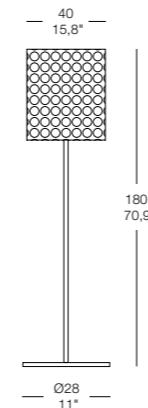

BROADWAY/SO 40

- 4 x MAX 60W E27 inc.
 - o/or
 - 4 x MAX 42W E27 alo.
- CE IP 20

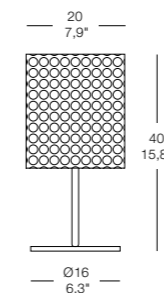

BROADWAY/TA

- 1 x MAX 100W E27 inc.
 - o/or
 - 1 x MAX 70W E27 alo.
 - o/or
 - 1 x 20W E27 PL-EL
- CE IP 20

BROADWAY

technical detailed lists

design **andrea lazzari**

Collezione di lampade in metallo cromo satinato e oro satinato, le versioni da tavolo e terra hanno la base in vetro extrachiaro, i paralumi sono in paillettes di colore oro, argento e nero.

Collection of lamps in satin-finished metal available in the finishes chrome or gold, table lamps and floor lamps with base in extra clear glass, lampshades in paillettes in gold, silver or black colour.

Collection de lampes en métal satiné avec finitions chrome ou or, lampes à poser et lampadaires avec base en verre extra-clair, diffuseur en paillettes dans les couleurs or, argent ou noir.

Colección de lámparas en metal cromo satinado y oro satinado, los modelos de mesa y de piso tienen la base en vidrio extraclaro, las pantallas son en paillettes de color oro, plata y negro.

Serie aus satiniertem Metall in den Ausführungen chrom oder gold, Tischleuchten und Stehleuchten mit Basis aus extraklarem Glas, Lampenschirm aus Paillettes in den Farben gold, silver oder schwarz.

Collezione di lampade in metallo, satinato e oro satinato, le versioni da tavolo e terra hanno la base in vetro extrachiaro, i paralumi sono in paillettes di colore oro, argento e nero.

+
dress









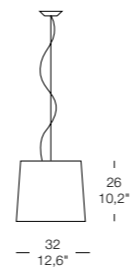

DRESS SO 32

- 1 x MAX 100W E27 alo./inc.
 - o/or
 - 1 x MAX 70W E27 alo.
 - o/or
 - 1 x 23W E27 PL-EL
- CE IP 20

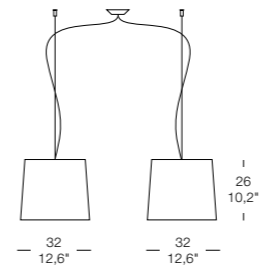

DRESS SO 32/2

- 2 x MAX 100W E27 alo./inc.
 - o/or
 - 2 x MAX 70W E27 alo.
 - o/or
 - 2 x 23W E27 PL-EL
- CE IP 20

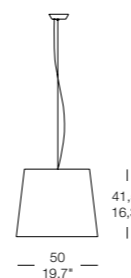

DRESS SO/C

- 1 x MAX 150W E27 alo./inc.
 - o/or
 - 1 x MAX 105W E27 alo.
 - o/or
 - 1 x 23W E27 PL-EL
- CE IP 20

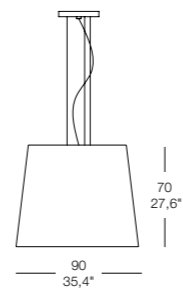

DRESS SO/XXL

- 4 x MAX 150W E27 alo./inc.
 - o/or
 - 4 x MAX 105W E27 alo.
 - o/or
 - 4 x 23W E27 PL-EL
- CE IP 20

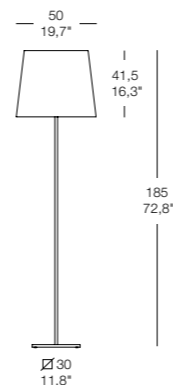

DRESS/TE

- 1 x MAX 150W E27 alo./inc.
 - o/or
 - 1 x MAX 140W E27 alo.
- CE IP 20

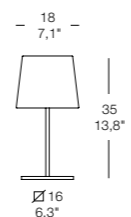

DRESS/CO

- 1 x MAX 60W E14 inc.
 - o/or
 - 1 x MAX 42W E14 alo.
- CE IP 20

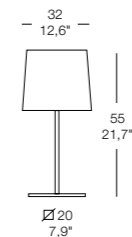

DRESS/TA

- 1 x MAX 100W E27 inc.
 - o/or
 - 1 x MAX 70W E27 alo.
 - o/or
 - 1 x 20W E27 PL-EL
- CE IP 20

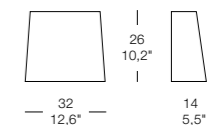

DRESS/PA

- 1 x MAX 100W E27 inc.
 - o/or
 - 1 x MAX 70W E27 alo.
 - o/or
 - 1 x 20W E27 PL-EL
- CE IP 20

DRESS

technical
detailed lists

design **andrea lazzari**
e **massimo tonetto**

Collezione di lampade in acciaio inox satinato, diffusore in tessuto metallico, colore silver, rosso e avorio.

Collection of lamps satin finished stainless steel, metal fabric diffuser in the colours silver, red and ivory.

Collection de lampes en acier inox satiné, diffuseur en tissu métallique dans les couleurs silver, rouge et ivoire.

Colección de lámparas en acero inox satinado, difusor en tejido metálico, color silver, rojo y marfil.

Serie in Stahl Inox satiniert, Schirm Metallgewebe in den Farben silver, rot und elfenbein.

Collección de lámpas de satinirovannoy nerzhaveyushchey stali, otrazhatel' iz metallicheskoy tkani serebryannogo, krasnogo tsveta i tsveta slonovoy kosti.

+ butterfly



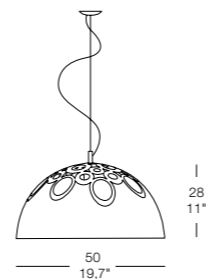



BUTTERFLY/SO

1 x MAX 150W E27 inc. 

o/or

1 x MAX 105W E27 alb.  ENERGY SAVER

o/or

1 x 21W E27 PL-EL  ENERGY SAVING

CE  IP 20

BUTTERFLY

technical
detailed lists

design **andrea lazzari**

Collezione di sospensioni in metallo, verniciatura antigraffio nelle colorazioni; Arancio Sun, Bianco Moon e Nero Crow.

Collection of suspensions in metal, with anti-scratch lacquering in the colours Sun orange, Moon white and Crow black.

Collection de suspensions en métal, vernis anti-égratignure dans les couleurs Sun orange, Moon blanc et Crow noir.

Colección de suspensiones en metal, barniz irrayable en colores Anaranjado Sun, Blanco Moon y Negro Crow.

Serie von Hängelampen aus Metall, mit anti-kratzen Lackierung in den Farben Sun orange, Moon weiß und Crow schwarz.

Коллекция подвесок из металла, нецарапываемая окраска в цветах: Оранжевый Солнечный, Белый Лунный и Черный Вороной.



+ young
young
mini



MOROSINI

154 / 155



DESIGN ANDREA LAZZARI E MASSIMO TONETTO

YOUNG/SO 3 MINI (BONE CHINA) + SYSTEM 100 A

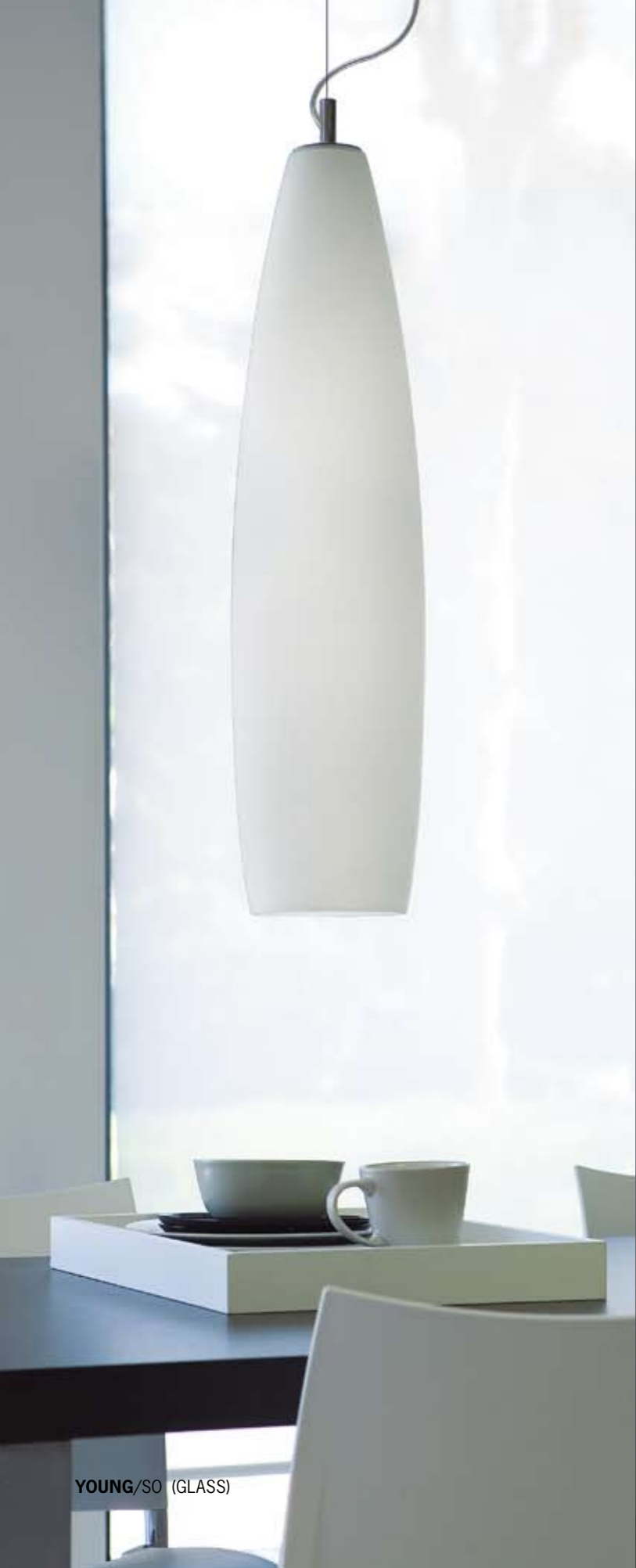

YOUNG/SO (GLASS)



YOUNG/TE (GLASS)

MOROSINI

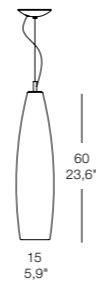

YOUNG SO

1 x MAX 100W E27 alo./inc.
 o/or
 1 x MAX 70W E27 alo.
 o/or
 1 x 23W PL-EL

CE F IP 20

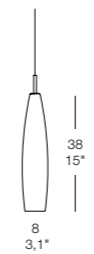

YOUNG/SO MINI

1 x MAX 75W G9 halopin
 o/or
 1 x MAX 42W G9 alo.

CE F IP 20

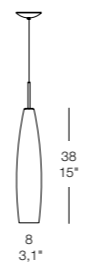

YOUNG/SO 1 MINI

1 x MAX 75W G9 halopin
 o/or
 1 x MAX 42W G9 alo.

CE F IP 20

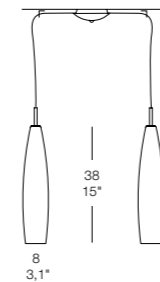

YOUNG/SO 2 MINI

2 x MAX 75W G9 halopin
 o/or
 2 x MAX 42W G9 alo.

CE F IP 20

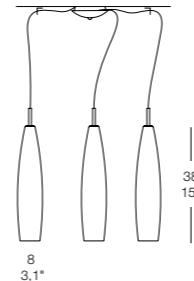

YOUNG/SO 3 MINI

3 x MAX 75W G9 halopin
 o/or
 3 x MAX 42W G9 alo.

CE F IP 20

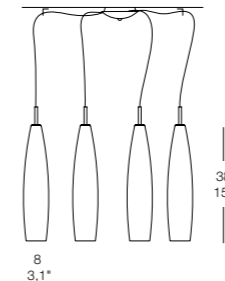

YOUNG/SO 4 MINI

4 x MAX 75W G9 halopin
 o/or
 4 x MAX 42W G9 alo.

CE F IP 20

SYSTEM 100 A

100 - 39,4"
 3 - 1,2"

SYSTEM 150 A

150 - 59,1"
 3 - 1,2"

CE F IP 20

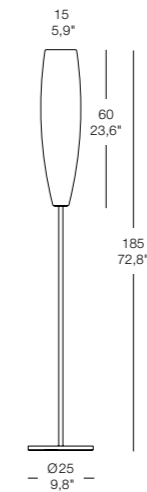

YOUNG TE

1 x MAX 150W E27 alo./inc.
 o/or
 1 x MAX 140W E27 alo.

CE F IP 20

DRESS

technical detailed lists

design **andrea lazzari**
 e **massimo tonetto**

Collezione di lampade in metallo cromato, diffusore in vetro soffiato bianco latte satinato e solo per versione Mini Young in Bone China bianco con finitura lucida.

Collection of lamps in chrome-metal, diffuser in satinéd milk white blown glass and only for the versions MINI YOUNG in white Bone China, polished finish.

Collection de lampes en métal chromé, diffuseur en verre soufflé blanc lait satiné et seulement pour les versions MINI YOUNG en Bone China blanc, finition brillante.

Colección de lámparas en metal cromado, difusor en cristal soplado blanco leche satinado y solo para la versión MINI YOUNG en Bone China blanco con acabado lucido.

Serie aus Metall Chrom, Schirm aus Mund geblasenem Glas milch weiss satiniert und nur für die Version MINI YOUNG aus Bone China, weiß glänzend.

Collección de lámpas de metal cromado, reflector de vidrio soplado de color blanco satinado y solo para la versión MINI YOUNG de Bone China con acabado brillante.

+
egg



EGG/PA (GLASS)

MOROSINI

158 / 159

DESIGN UFFICIO STILE



EGG/TE (BONE CHINA)



EGG/S01 (BONE CHINA)



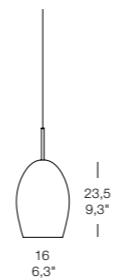

DESIGN UFFICIO STILE

EGG/S02 (BONE CHINA)



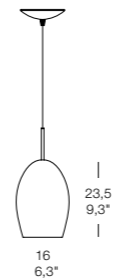

EGG/SO

1 x MAX 100W E27 inc. 
 o/or
 1 x MAX 70W E27 alo.  ENERGY SAVER
 o/or
 1 x 20W PL-EL  ENERGY SAVING ES
 CE F IP 20



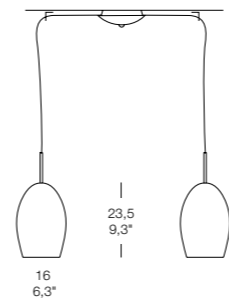

EGG/SO1

1 x MAX 100W E27 inc. 
 o/or
 1 x MAX 70W E27 alo.  ENERGY SAVER
 o/or
 1 x 20W PL-EL  ENERGY SAVING ES
 CE F IP 20



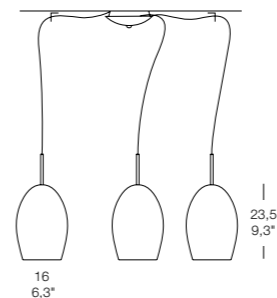

EGG/SO2

2 x MAX 100W E27 inc. 
 o/or
 2 x MAX 70W E27 alo.  ENERGY SAVER
 o/or
 2 x 20W PL-EL  ENERGY SAVING ES
 CE F IP 20



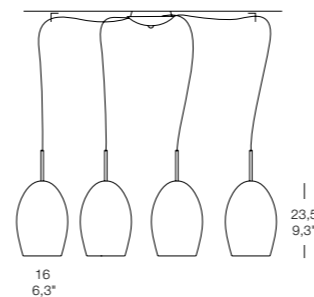

EGG/SO3

3 x MAX 100W E27 inc. 
 o/or
 3 x MAX 70W E27 alo.  ENERGY SAVER
 o/or
 3 x 20W PL-EL  ENERGY SAVING ES
 CE F IP 20



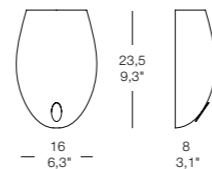

EGG/SO4

4 x MAX 100W E27 inc. 
 o/or
 4 x MAX 70W E27 alo.  ENERGY SAVER
 o/or
 4 x 20W PL-EL  ENERGY SAVING ES
 CE F IP 20



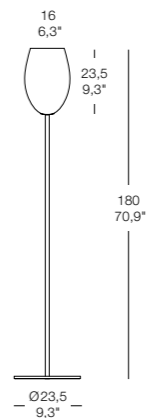

EGG/PA

2 x MAX 40W E14 inc. 
 o/or
 2 x MAX 28W E14 alo.  ENERGY SAVER
 CE F IP 20



EGG/TE

1 x MAX 100W E27 alo./inc. 
 o/or
 1 x MAX 70W E27 alo.  ENERGY SAVER
 CE F IP 20

EGG

technical detailed lists

design ufficio stile

Collezione di lampade in metallo cromato, diffusore in Bone China bianco con finitura lucida o in vetro soffiato bianco latte satinato.

Collection of lamps in chrome-metal, diffuser in white Bone China, polished finish or in satined milk white blown glass.

Collection de lampes en métal chromé, diffuseur en Bone China blanc, finition brillante ou en verre soufflé blanc lait satiné.

Colección de lámparas en metal cromado, difusor en Bone China blanco, con acabado lucido o en cristal soplado blanco leche satinado.

Serie in Chrom, Schirm aus Bone China, weiß glänzend oder aus mundgeblasenem Glas milchweiss satiniert.

Коллекция ламп из хромированного металла, отражатель из белого Bone China с блестящей отделкой или из выдувного стекла сатинированного молочно-белого цвета.

SYSTEM 100 A

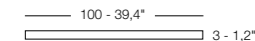

SYSTEM 150 A

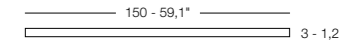

CE F IP 20

+
evo



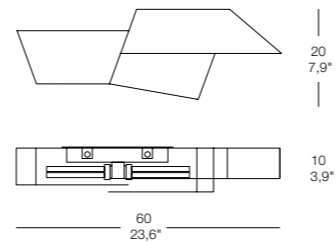

EVO PA 60

2 x MAX 26W G24q3

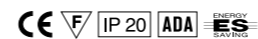

Ballast elettronico / Electronic ballast
Elektronische Vorschaltgerate
Ballast électronique / Ballast electrónico
Электронный балласт

EVO

technical
detailed lists

design **serena papait**

Lampada da parete in metallo piegato con angolazioni scomposte che generano un gioco di luci ed ombre.

Metal wall lamp of irregular shape. Its asymmetrical components create a nice light effect on the wall.

Aplique en metal.
Les composants asymétriques projettent un beau jeu de lumière sur le mur.

Lámpara de pared en metal.
Las componentes asimétricas proyectan en la pared un juego de luz y sombra.

Wandleuchte aus Metall.
Die asymmetrischen Teilen werfen ein schönes Lichtspiel an die Wand.

Бра необычной формы из металла. Асимметричные детали создают неповторимый световой эффект на стену.

+ eye



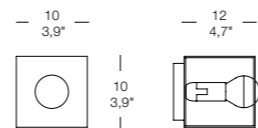

EYE PA

1 x MAX 40W E14 inc. 

LAMPADINA INCLUSA
BULB INCLUDED

EYE

technical
detailed lists

design **andrea lazzari**

Lampada da parete in alluminio anodizzato, nei colori alluminio, nero, oro.

Wall bracket lamp in anodized aluminium, in the colours aluminium, black and gold.

Applique en aluminium anodisé, dans les couleurs aluminium, noir et or.

Aplique en aluminio anodizado, color aluminio, negro y oro.

Wandleuchter in rein Aluminium eloxiert, in den Farben aluminium, schwarz und gold.

Настенная лампа из анодированного алюминия, алюминиевого цвета, чёрного цвета и золотого цвета.

+ sketch

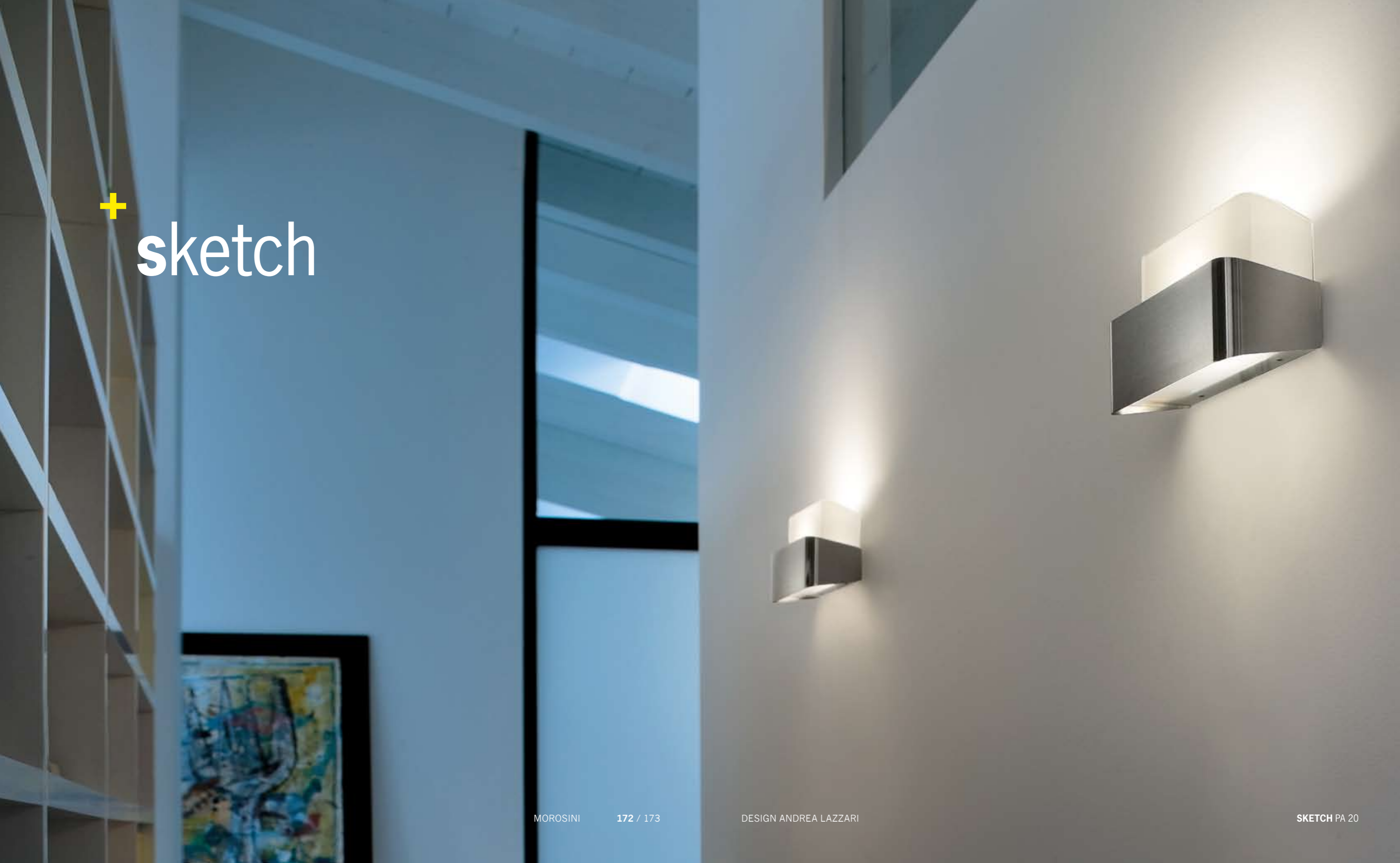





SKETCH PA 65 E

SKETCH

technical
detailed lists

design **andrea lazzari**

Collezione di lampade in metallo disponibile nelle finiture: acciaio inox satinato, acciaio inox lucido e alluminio anodizzato oro. Vetro extrachiaro serigrafato bianco con finitura lucida.

Collection of lamps in metal available in: satin finish stainless steel, polished stainless steel and gold anodized aluminium. Polished, extra-clear glass with white screen-printing.

Collection de lampes en metal disponible en: acier inox satiné, acier inox poli et aluminium anodisé en couleur or. Verre extra-claire poli avec serigraphie blanche

Colección de lámparas en metal disponible en: acero satinado y inoxidable, acero inoxidable lucido y aluminio anodizado oro. Vidrio extra claro lucido, serigrafado en blanco.

Serie aus Metall verfügbar in den Ausführungen: Inox Stahl satiniert, Inox Stahl poliert und Aluminium anodisiert goldfarbig. Poliertes extraklare Glas mit weißem Siebdruckverfahren.

Коллекция представлена в матовой или полированной нержавеющей стали и алюминии, анодированном золотом. Полированное экстра-прозрачное стекло с белыми элементами.

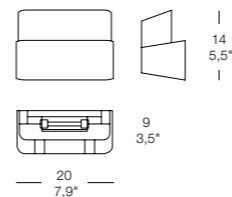

SKETCH PA 20

1 x MAX 80W R7s 74,9 mm. ENERGY SAVER

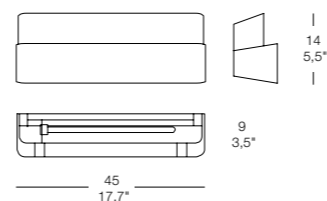

SKETCH PA 45 E

1 x MAX 24W 2G11 fluo. ENERGY SAVER

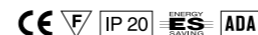

Ballast elettronico / electronic ballast
Elektronische Vorschaltgeräte
Ballast électronique / Ballast electronic
Электронный балласт

SKETCH PA 45 E DIM

1 x MAX 24W 2G11 fluo. ENERGY SAVER

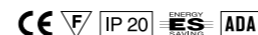

Ballast elettronico / electronic ballast
Elektronische Vorschaltgeräte
Ballast électronique / Ballast electronic
Электронный балласт

Dimmerabile / Dimmable / Dimmbar
Возможность регулировки
интенсивности света

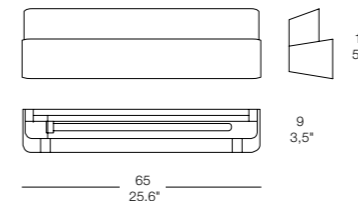

SKETCH PA 65 E

1 x MAX 55W 2G11 fluo. ENERGY SAVER

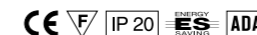

Ballast elettronico / electronic ballast
Elektronische Vorschaltgeräte
Ballast électronique / Ballast electronic
Электронный балласт

SKETCH PA 65 E DIM

1 x MAX 55W 2G11 fluo. ENERGY SAVER

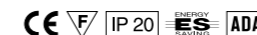

Ballast elettronico / electronic ballast
Elektronische Vorschaltgeräte
Ballast électronique / Ballast electronic
Электронный балласт

Dimmerabile / Dimmable / Dimmbar
Возможность регулировки
интенсивности света

+
nemesi





NEMESI 23/PA

MOROSINI



DESIGN ANDREA LAZZARI E MASSIMO TONETTO

NEMESI/PP - NEMESI/PP E



NEMESI

technical
detailed lists

design **andrea lazzari**
e **massimo tonetto**

Collezione di lampade in alluminio anodizzato, vetro extrachiaro serigrafato bianco, con finitura satinata.

Collection of lamps in anodized aluminium metal, extra clear glass with screen printing in white, satin finish.

Collection de lampes en aluminium anodisé, verre extra-clair sérigraphié en blanc, finition satinée.



Colección de lámparas en aluminio anodizado, cristal extraclaro serigrafado blanco, amarillo, aranjado o verde manzana, acabado satinado.

Serie aus eloxiertem Aluminium, Glas extraktlar mit Siebdruck weiß, satiniert.

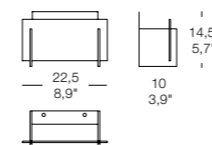
Коллекция ламп из анодированного алюминия, экстрасветлое сериграфированное стекло белого цвета с сатирированной отделкой.



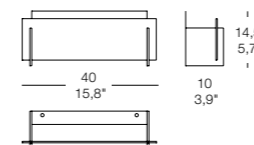

NEMESI 23/PA

1 x MAX 150W
R7s 114,2 mm. 
o/or
1 x MAX 120W
R7s 114,2 mm. 
CE **F** **IP 20** **ADA**



NEMESI 40/PA

2 x MAX 150W
R7s 114,2 mm. 
o/or
2 x MAX 120W
R7s 114,2 mm. 
CE **F** **IP 20** **ADA**

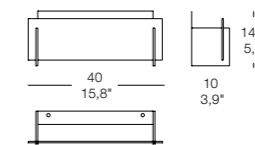

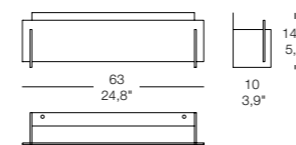

NEMESI 40/PA E

1 x MAX 24W 2G11 fluo 
CE **F** **IP 20** **ES** **ADA**
E: ballast elettronico/
electronic ballast



NEMESI 63/PA

2 x MAX 150W
R7s 114,2 mm. 
o/or
2 x MAX 120W
R7s 114,2 mm. 
CE **F** **IP 20** **ADA**

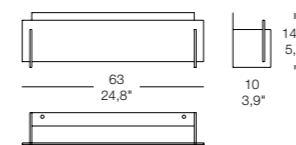

NEMESI 63/PA E

1 x MAX 55W 2G11 fluo 
CE **F** **IP 20** **ES** **ADA**
E: ballast elettronico/
electronic ballast

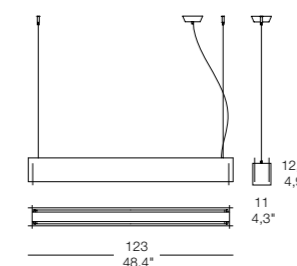

NEMESI/SO E - NEMESI/SO E DIM.

2 x MAX 54W
G5 fluo 
CE **F** **IP 20** **ES**
E: ballast elettronico/electronic ballast
DIM: dimmerabile / dimmable / dimmbar
Возможность регулировки
интенсивности света

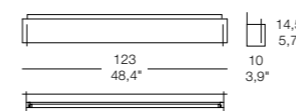

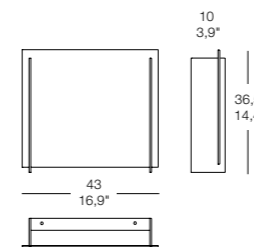

NEMESI 123/PA E

1 x MAX 54W G5 fluo 
CE **F** **IP 20** **ES** **ADA**
E: ballast elettronico/
electronic ballast



NEMESI/PP

4 x MAX 60W E14 inc. 
o/or
4 x MAX 42W E14 alo. 
CE **F** **IP 20** **ADA**

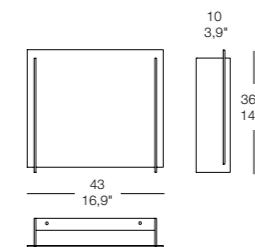

NEMESI/PP E

2 x MAX 24W 2G11 fluo 
CE **F** **IP 20** **ES** **ADA**
E: ballast elettronico/
electronic ballast

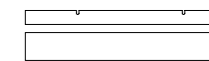

KIT NEMESI/PP - PPE

Opzionale: 2 schermi protezione in policarbonato.
Optional: 2 protective polycarbonate screens.
Optional: 2 Lichtschutzen aus Polycarbonat.
Optional: 2 écrans de protection en polycarbonate.
Opcional: 2 pantallas de proteccion en policarbonato.
Дополнительно: 2 защитных экрана из поликарбоната.

+ sunrise





SUNRISE/500 PA



SUNRISE/260 PA



SUNRISE/PA-GLASS

MOROSINI 190 / 191



DESIGN UFFICIO STILE

SUNRISE/PA

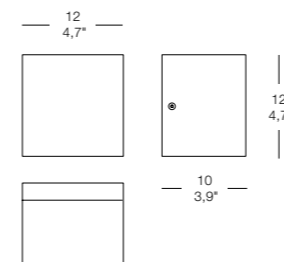

SUNRISE 120/PA GLASS

1 x MAX 75W G9 halopin
 o/or
 1 x MAX 42W G9 alo. ENERGY SAVER
 CE F IP 40 ADA

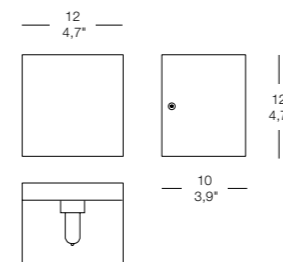

SUNRISE 120/PA

1 x MAX 75W G9 halopin
 o/or
 1 x MAX 42W G9 alo. ENERGY SAVER
 CE F IP 20 ADA

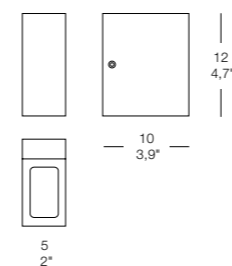

SUNRISE/PA GLASS

1 x MAX 60W G9 halopin
 o/or
 1 x MAX 42W G9 alo. ENERGY SAVER
 CE F IP 40 ADA

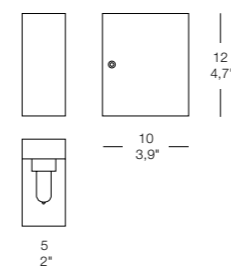

SUNRISE/PA

1 x MAX 75W G9 halopin
 o/or
 1 x MAX 42W G9 alo. ENERGY SAVER
 CE F IP 20 ADA

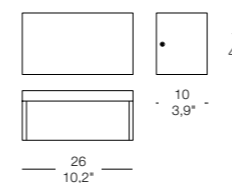

SUNRISE/260 PA

1 x MAX 150W
 R7s 114,2 mm.
 o/or
 1 x MAX 120W
 R7s 114,2 mm. ENERGY SAVER
 CE F IP 40 ADA

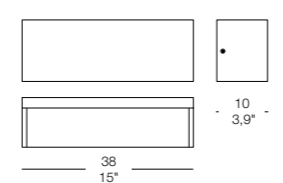

SUNRISE/380 PA

2 x MAX 100W
 R7s 74,9 mm.
 o/or
 2 x MAX 80W
 R7s 74,9 mm. ENERGY SAVER
 CE F IP 40 ADA

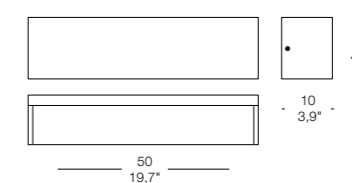

SUNRISE/500 PA

2 x MAX 150W
 R7s 114,2 mm.
 o/or
 2 x MAX 120W
 R7s 114,2 mm. ENERGY SAVER
 CE F IP 40 ADA

SUNRISE/260 PA E

1 x MAX 24W 2G11 Fluo
 CE F IP 40 ES ADA

E: ballast elettronico/
 electronic ballast

SUNRISE/380 PA E

1 x MAX 24W 2G11 Fluo
 CE F IP 40 ES ADA

E: ballast elettronico/
 electronic ballast

SUNRISE/500 PA E

1 x MAX 36W 2G11 Fluo
 CE F IP 40 ES ADA

E: ballast elettronico/
 electronic ballast

SUNRISE

technical
 detailed lists

design **Ufficio Stile**

SUNRISE: Lampade da parete in acciaio nelle finiture; inox satinato, bianco e nero, disponibile in versione con lenti ottiche trasparenti.

Wall bracket lamps made of steel in the finishes satin stainless steel, white and black, available with transparent optical lenses.

Appliques en acier avec finitions acier inox satiné, blanc et noir, disponible avec lentilles optiques transparentes.

Apliques acabado en acero, acero inox satinado, blanco y negro, disponible con lentes opticas transparentes.

Wandleuchten aus Stahl in den Ausführungen Stahl Inox satiniert, weiß und schwarz, erhältlich auch mit optischer transparenten Linse.

Настенные лампы из стали в отделке; сатинированная нержавеющая сталь белого и черного цвета предоставляется в версии с прозрачными оптическими линзами.

SUNRISE 120 - 260 - 380 - 500: Lampade da parete in acciaio nelle finiture; inox satinato, bianco e nero, disponibile in versione con vetro extrachiaro satinato.

Wall bracket lamps made of steel in the finishes satin stainless steel, white and black, available with extra clear satin glass.

Applique en acier avec finitions acier inox satiné, blanc et noir, disponible avec verre extra-clair satiné.

Apliques acabado en acero, acero inox satinado, blanco y negro, disponible con cristal extraclaro satinado.

Wandleuchten aus Stahl in den Ausführungen Stahl Inox satiniert, weiß und schwarz, erhältlich auch mit extraklarem satinierten Glas.

Настенные лампы из стали в отделке; сатинированная нержавеющая сталь белого и черного цвета предоставляется в версии с экстрасветлым сатинированным стеклом.

+
zeus





ZEUS

technical
detailed lists

design **andrea lazzari**
e **massimo tonetto**

Lampade da parete in acciaio inox satinato, vetro extrachiario curvato serigrafato bianco con finitura satinata.

Wall bracket satin finished stainless steel, extra clear bent glass with white screen printing, satin finish.

Appliques en acier inox satiné, verre extra-clair courbe sérigraphié blanc, finition satinée.

Apliques en acero inox satinato, cristal extraclaro curvado serigrafado blanco, acabado satinado.

Wandleuchter aus Stahl Inox satiniert, Glas extraklar gebogen mit Siebdruck, weiß satiniert.

Настенные лампы из нержавеющей сатинированное стали, экстрасветлое стекло, изогнутое, белая сериграфия с сатинированной отделкой.

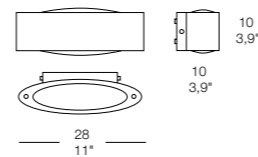

ZEUS 28/PA

1 x MAX 100W

R7s 74,9 mm.

o/or

1 x MAX 80W

R7s 74,9 mm.

CE IP 40 ADA

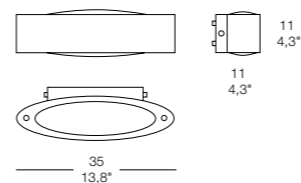

ZEUS 35/PA

1 x MAX 150W

R7s 114,2 mm.

o/or

1 x MAX 120W

R7s 114,2 mm.

CE IP 40

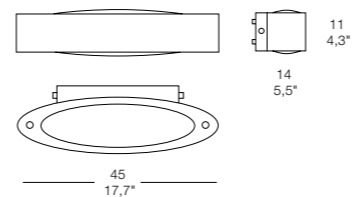

ZEUS 45/PA

2 x MAX 100W

R7s 74,9 mm.

o/or

2 x MAX 80W

R7s 74,9 mm.

CE IP 40

+ funzione

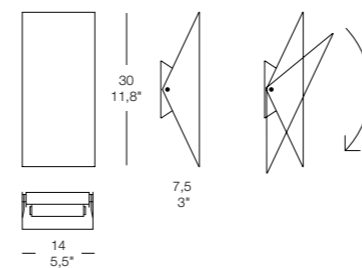

FUNZIONE/PA

1 x MAX 150W

R7s 74,9 mm. 

o/or

1 x MAX 120W

R7s 74,9 mm. 

CE  IP 20

FUNZIONE

technical
detailed lists

design **It Lab**

Lampada da parete in acciaio
inox satinato.

Wall bracket, satin finished
stainless steel.

Applique en acier inox satiné.

Aplique en acero inox satinado.

Wandleuchter aus Stahl
Inox satiniert.

Настенная лампа из
сатирированной
нержавеющей ткани.





EviStyle[®]
Passion for light

+
symphony



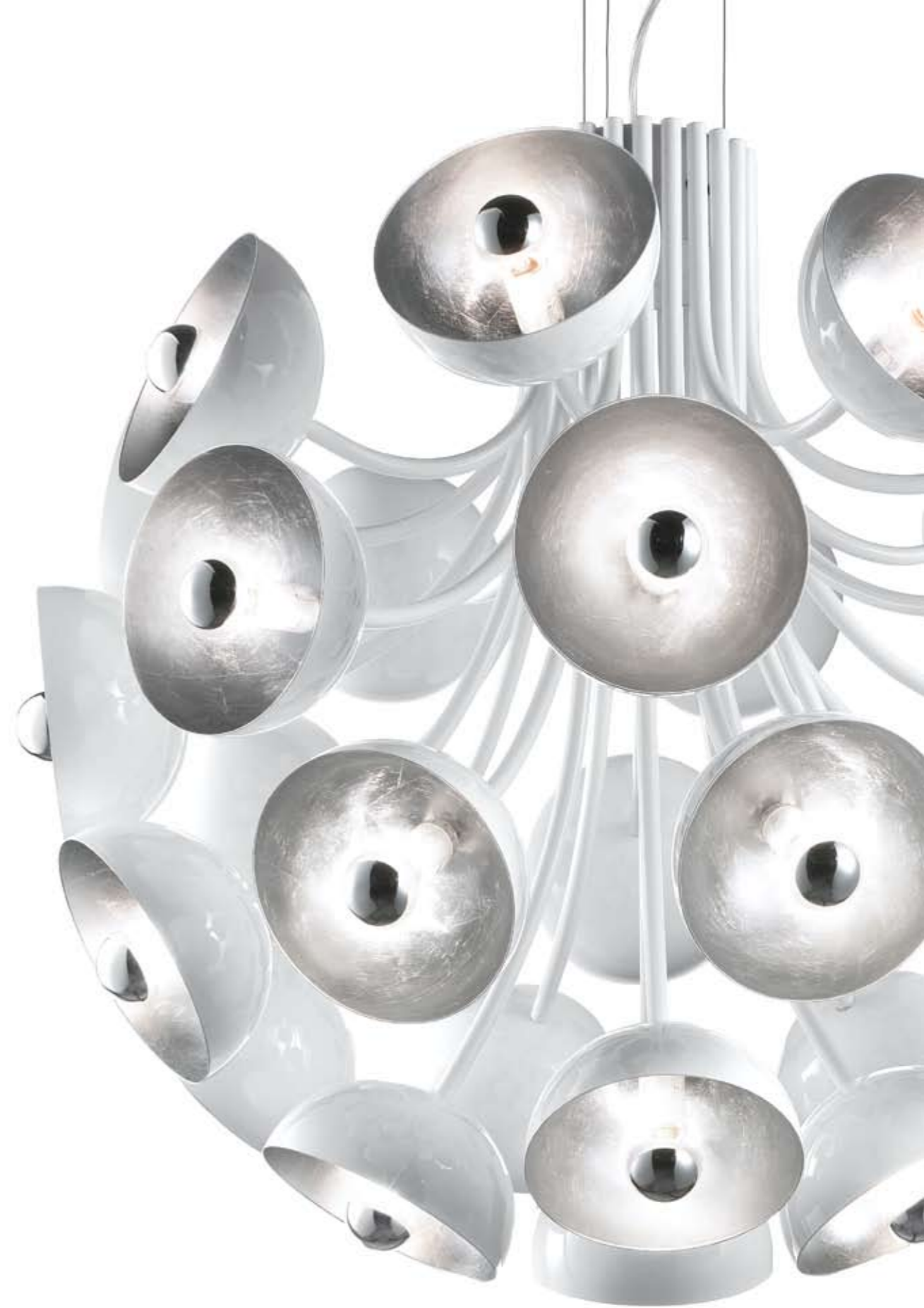



SYMPHONY LA 06 BI



SYMPHONY LA 06 FA



SYMPHONY LA 06 FO



SYMPHONY LA 07 BI



SYMPHONY LA 07 FA



SYMPHONY LA 07 FO



SYMPHONY LA 04 BI

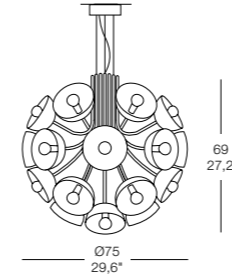

SYMPHONY LA75

28 x MAX 25W E14 inc.

o/or

28 x MAX 25W E14 inc.

o/or

28 x MAX 7W E14 fluo

CE IP 20

SYMPHONY

technical detailed lists

design **Brian Rasmussen**

Lampadario in metallo disponibile nelle finiture: cromo lucido con diffusore bianco lucido; bianco lucido con diffusore in foglia oro o argento oppure completamente bianco; nero lucido con diffusore in foglia oro o argento o bianco lucido.

Metal pendant available in the following finishes: polished chrome with glossy white diffuser; polished white with gold leaf or silver leaf diffuser or completely white; polished black with gold leaf, silver leaf or glossy white diffuser.

Lustre en métal disponible dans les finitions: chrome poli avec diffuseur blanc poli; blanc poli avec diffuseur en feuille d'or ou d'argent ou complètement blanc; noir poli avec diffuseur en feuille d'or ou d'argent ou blanc poli.

Metallampe verfügbar in den folgenden Ausführungen: glanzchrom mit glänzendem weißen Diffusor; glänzendes weiß mit Diffusor in Gold- oder Silberfolie oder komplett weiß; glänzendes schwarz mit Diffusor in Gold- oder Silberfolie oder weiß glänzend.

Lámpara de techo con estructura en metal disponible en los acabados: cromo brillante y difusor en color blanco brillante; blanco brillante y difusor con hoja de oro o plata o todo blanco; negro brillante y difusor con hoja de oro o plata o blanco brillante.

Металлическая лампа предоставляется в следующих вариантах отделки: блестящей хромированной с блестящим белым рассеивателем, блестящей белой с рассеивателем из золотого или серебряного листа или полностью белой, блестящей черной с рассеивателем из золотого или серебряного листа или блестящей белой.

+ retrò
retrò soft





RETRO TE

EVISTYLE

212 / 213



DESIGN ANDREA LAZZARI

RETRO SOFT TE





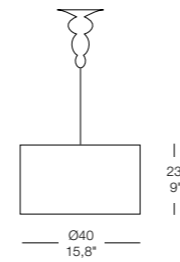

RETRÒ SO 40

- 1 x MAX 150W
E27 alo. / inc.
- o/or
- 1 x MAX 105W
E27 alo. ENERGY SAVER
- o/or
- 1 x MAX 23W
E27 PL-EL ENERGY SAVER

RETRÒ SOFT SO 40

- 1 x MAX 150W E27 alo.
 - o/or
 - 1 x MAX 105W
E27 alo. ENERGY SAVER
 - o/or
 - 1 x MAX 23W
E27 PL-EL ENERGY SAVER
- CE F IP 20

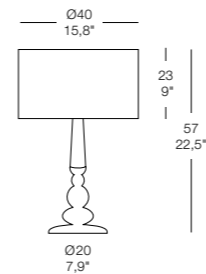

RETRÒ TA

- 1 x MAX 150W
E27 alo. / inc.
- o/or
- 1 x MAX 105W
E27 alo. ENERGY SAVER
- o/or
- 1 x MAX 23W
E27 PL-EL ENERGY SAVER

RETRÒ SOFT TA

- 1 x MAX 150W E27 alo.
 - o/or
 - 1 x MAX 105W
E27 alo. ENERGY SAVER
 - o/or
 - 1 x MAX 23W
E27 PL-EL ENERGY SAVER
- CE F IP 20

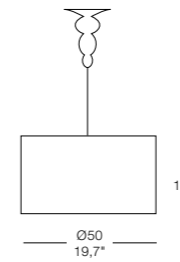

RETRÒ SO 50

- 1 x MAX 150W
E27 alo. / inc.
- o/or
- 1 x MAX 105W
E27 alo. ENERGY SAVER
- o/or
- 1 x MAX 23W
E27 PL-EL ENERGY SAVER

RETRÒ SOFT SO 50

- 1 x MAX 150W E27 alo.
 - o/or
 - 1 x MAX 105W
E27 alo. ENERGY SAVER
 - o/or
 - 1 x MAX 24W
E27 PL-EL ENERGY SAVER
- CE F IP 20

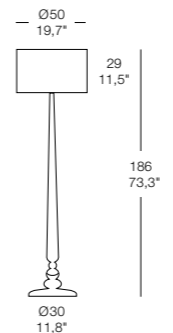

RETRÒ TE

- 1 x MAX 150W
E27 alo. / inc.
- o/or
- 1 x MAX 140W
E27 alo. ENERGY SAVER

RETRÒ SOFT TE

- 1 x MAX 150W
E27 alo. / inc.
 - o/or
 - 1 x MAX 140W
E27 alo. ENERGY SAVER
- CE F IP 20

RETRÒ: Collezione di lampade in legno, metallo, Alutex (tessuto in fibra di vetro composita) e fibra di carbonio composita. Disponibile nelle finiture Alutex "oro" con base foglia oro, Alutex "argento" con base foglia argento, fibra di carbonio nera con base in nero opaco o foglia oro o foglia argento.

Collection of lamps in wood, metal, Alutex (fabric made of composite glass fibre) and composite carbon fibre. Available in the finishes Alutex "gold" with base in gold leaf, Alutex "silver" with base available in the finishes matt black, gold leaf or silver leaf.

Collection de lampes en bois, metal, Alutex (tissu de fibre composite de verre) et fibre composite de carbone. Available dans les finitions Alutex "or" avec base en feuille d'or, Alutex "silver" avec base en feuille d'argent, fibre de carbone noir avec base available dans les finitions noir opaque, feuille d'or ou feuille d'argent.

Kollektion von Leuchten aus Holz, Metall, Alutex (Stoff aus mehrteiligem Glasfaser) und mehrteiliges Kohlenstoff-Fiber. Verfügbar in den Ausführungen Alutex "gold" mit Fuß in Goldfolie, Alutex "silber" mit Fuß in Silberfolie, schwarze Kohlenstoff-Fiber mit Fuß verfügbar in den Ausführungen matt Schwarz, Goldfolie oder Silberfolie.

Colección de lamparas en madera, metal, Alutex (tejido en fibra de vidrio compuesta) y fibra de carbono compuesta. Disponible en acabados Alutex "oro" con base en hoja plata, fibra de carbono negro con base en los acabados negro opaco, hoja oro o hoja plata.

Коллекция ламп из дерева, металла, Алютекса (смесовая ткань из стекловолокна) и смесового углеродистого волокна. Предоставляется в вариантах отделки Алютекс «позолоченный» с основанием из золотого листа, Алютекс «серебрянный» с основанием из серебряного листа, углеродистого волокна черного цвета с черным матовым основанием или золотым или серебрянным листом.

RETRÒ RETRÒ SOFT

technical
detailed lists

design **andrea lazzari**

RETRÒ SOFT: Collezione di lampade in legno, metallo, Alutex (tessuto in fibra di vetro composita) e fibra di carbonio composita. Disponibile nelle finiture Alutex "oro" con base foglia oro, Alutex "argento" con base foglia argento, fibra di carbonio nera con base in nero opaco o foglia oro o foglia argento. Paralumi in tessuto Pongé bianco o nero.

Collection of lamps in wood, metal, Alutex (fabric made of composite glass fibre) and composite carbon fibre. Available in the finishes Alutex "gold" with base in gold leaf, Alutex "silver" with base in silver leaf, black carbon fiber with base available in the finishes matt black, gold leaf or silver leaf. Lampshades in Pongé fabric white or black.

Collection de lampes en bois, metal, Alutex (tissu de fibre composite de verre) et fibre composite de carbone. Available dans les finitions Alutex "or" avec base en feuille d'or, Alutex "silver" avec base en feuille d'argent, fibre de carbone noir avec base available dans les finitions noir opaque, feuille d'or ou feuille d'argent. Diffuseurs en tissu Pongé blanc ou noir.

Kollektion von Leuchten aus Holz, Metall, Alutex (Stoff aus mehrteiligem Glasfaser) und mehrteiliges Kohlenstoff-Fiber. Verfügbar in den Ausführungen Alutex "gold" mit Fuß in Goldfolie, Alutex "silber" mit Fuß in Silberfolie, schwarze Kohlenstoff-Fiber mit Fuß verfügbar in den Ausführungen matt Schwarz, Goldfolie oder Silberfolie. Lampenschirme aus Pongé stoffe weiß oder schwarz.

Colección de lamparas en madera, metal, Alutex (tejido en fibra de vidrio compuesta) y fibra de carbono compuesta. Disponible en acabados Alutex "oro" con base en hoja oro, Alutex "plata" con base en hoja plata, fibra de carbono negro con base en los acabados negro opaco, hoja oro o hoja plata. Pantallas en tejido Pongé blanco o negro.

Коллекция ламп из дерева, металла, Алютекса (смесовая ткань из стекловолокна) и смесового углеродистого волокна. Предоставляется в вариантах отделки Алютекс «позолоченный» с основанием из золотого листа, Алютекс «серебрянный» с основанием из серебряного листа, углеродистого волокна черного цвета с черным основанием или золотым или серебряным листом. Абажуры из белой или черной ткани Pongé.

+ frisé
frisé mini





FRISÉ SO 6

EVISTYLE

224 / 225



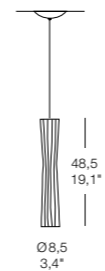

DESIGN ANDREA LAZZARI

FRISÉ SO 9



FRISÈ S01 G9

1 x MAX 60W G9 halopin 
 o/or
 1 x MAX 42W G9 alo.  ENERGY SAVER

FRISÈ S01 PAR AL



1 x MAX 50W GU10 

FRISÈ S01 PAR FL

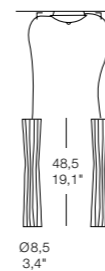
1 x MAX 11/14W
 GU10 fluo.  ENERGY SAVER
 CE F IP 20



FRISÈ S02 G9

2 x MAX 60W G9 halopin 
 o/or
 2 x MAX 42W G9 alo.  ENERGY SAVER

FRISÈ S02 PAR AL



2 x MAX 50W GU10 

FRISÈ S02 PAR FL

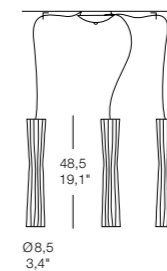
2 x MAX 11/14W
 GU10 fluo.  ENERGY SAVER
 CE F IP 20



FRISÈ S03 G9

3 x MAX 60W G9 halopin 
 o/or
 3 x MAX 42W G9 alo.  ENERGY SAVER

FRISÈ S03 PAR AL



3 x MAX 50W GU10 

FRISÈ S03 PAR FL

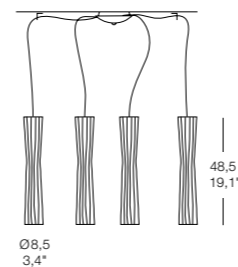
3 x MAX 11/14W
 GU10 fluo.  ENERGY SAVER
 CE F IP 20



FRISÈ S04 G9

4 x MAX 60W G9 halopin 
 o/or
 4 x MAX 42W G9 alo.  ENERGY SAVER

FRISÈ S04 PAR AL



4 x MAX 50W GU10 

FRISÈ S04 PAR FL

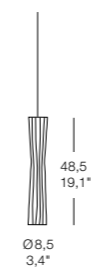
4 x MAX 11/14W
 GU10 fluo.  ENERGY SAVER
 CE F IP 20



FRISÈ S0 G9

1 x MAX 60W G9 halopin 
 o/or
 1 x MAX 42W G9 alo.  ENERGY SAVER

FRISÈ S0 PAR AL

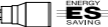

1 x MAX 50W GU10 

FRISÈ S0 PAR FL

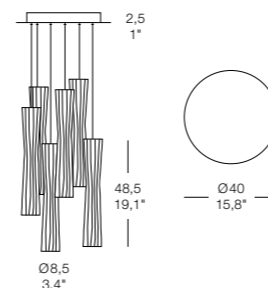
1 x MAX 11/14W
 GU10 fluo.  ENERGY SAVER
 CE F IP 20





FRISÈ S06 G9

6 x MAX 60W G9 halopin 
 o/or
 6 x MAX 42W G9 alo.  ENERGY SAVER

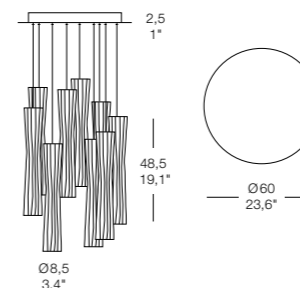
CE F IP 20



FRISÈ S09 G9

9 x MAX 60W G9 halopin 
 o/or
 9 x MAX 42W G9 alo.  ENERGY SAVER

CE F IP 20

SYSTEM 100 A

100 - 39,4" 3 - 1,2"

SYSTEM 150 A

150 - 59,1" 3 - 1,2"

CE F IP 20

FRISÈ

technical detailed lists

design andrea lazzari

Collezione di lampade in metallo nichel satinato, oro satinato e rame satinato, diffusore in vetro lavorato a mano disponibile nelle colorazioni; bianco seta, nero, oro, argento e rame metallizzati.

Lamp collection with metal frame in nickel satin finish, gold satin finish or copper satin finish; hand-made glass diffuser available in the following colours: silk white, black, gold, silver and metallized copper.

Collection de lampes en métal nickel satiné, or satin et cuivre satiné, diffuseur en verre travaillé à la main disponible dans les coloris: blanc soie, noir, or, argent et cuivre métallisés.

Lampenkollektion bestehend aus satiniertem Nickel-, Gold- und Kupferfarbenem Metall, Diffusor aus handgefertigtem Glas in den folgenden Farben: Seidenweiß, Schwarz, Gold-, Silber- und Kupfermetalllic.



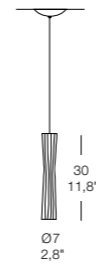

Colección de lámparas de metal níquel satinado, oro satinado y cobre satinado, pantalla de vidrio hecha a mano disponible en los colores blanco seda, negro, oro, plata y cobre metalizados

Коллекция металлических ламп из сатирированного никеля, сатирированного золота и сатирированной меди, стеклянный рассеиватель из стекла ручной обработки, предоставляется следующих цветов: белый шелковистый, Черный, металлизированный золотой, серебрянный и медный.







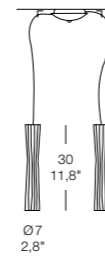

FRISÈ MINI S01 G9

1 x MAX 60W G9 halopin 
 o/or
 1 x MAX 42W G9 alo.  ENERGY SAVER
 CE  





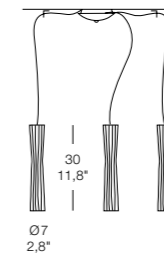

FRISÈ MINI S02 G9

2 x MAX 60W G9 halopin 
 o/or
 2 x MAX 42W G9 alo.  ENERGY SAVER
 CE  





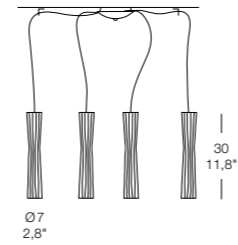

FRISÈ MINI S03 G9

3 x MAX 60W G9 halopin 
 o/or
 3 x MAX 42W G9 alo.  ENERGY SAVER
 CE  





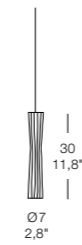

FRISÈ MINI S04 G9

4 x MAX 60W G9 halopin 
 o/or
 4 x MAX 42W G9 alo.  ENERGY SAVER
 CE  



FRISÈ MINI S0 G9

1 x MAX 60W G9 halopin 
 o/or
 1 x MAX 42W G9 alo.  ENERGY SAVER
 CE  

SYSTEM 100 A

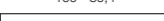
100 - 39,4" 
 3 - 1,2"



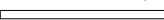

SYSTEM 150 A

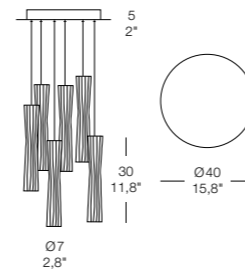
150 - 59,1" 
 3 - 1,2"

CE  





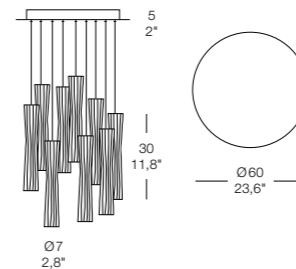

FRISÈ MINI S06 G9

6 x MAX 60W G9 halopin 
 o/or
 6 x MAX 42W G9 alo.  ENERGY SAVER
 CE  



FRISÈ MINI S09 G9

9 x MAX 60W G9 halopin 
 o/or
 9 x MAX 42W G9 alo.  ENERGY SAVER
 CE  

FRISÈ MINI

technical
detailed lists

design **andrea lazzari**

Collezione di lampade in metallo nichel satinato, oro satinato e rame satinato, diffusore in vetro lavorato a mano colore bianco seta.

Lamp collection with metal frame in nickel satin finish, gold satin finish or copper satin finish; hand-made glass diffuser, silk white colour.

Collection de lampes en métal nickel satiné, or satin et cuivre satiné, diffuseur en verre travaillé à la main en couleur blanc soie.

Lampenkollektion bestehend aus satiniertem Nickel-, Gold- und Kupferfarbenem Metall, Diffusor aus handgefertigtem Glas in der Farbe Seidenweiß.

Colección de lámparas de metal níquel satinado, oro satinado y cobre satinado, pantalla de vidrio hecha a mano en color blanco seda.

Коллекция металлических ламп из сатинированного никеля, сатинированного золота и сатинированной меди, стеклянный рассеиватель из стекла ручной обработки, предоставляется следующих цветов: белый шелковистый

+ queen m





QUEEN M TE
ORO / GOLD



QUEEN M PA
ARGENTO / SILVER



QUEEN M PA
FOGLIA ORO / GOLD LEAF

EVISTYLE

234 / 235



DESIGN BRIAN RASMUSSEN

QUEEN M S055
BIANCO / WHITE



QUEEN M

technical
detailed lists

design **brian rasmussen**

Collezione di lampade in metallo lavorato a mano, disponibile nelle finiture: foglia oro, foglia argento, bianco opaco, oro e argento.

Collection of lamps in hand-made worked metal, available in the finishes: gold leaf, silver leaf, matt white, gold and silver.

Collection de lampes en metal travaillé à main, disponibles dans les finitions: feuille d'or, feuille d'argent, blanc opaque, or et argent.

Kollektion von Leuchten aus handwerklich gearbeitetem Metall, verfügbar in den Ausführungen: Goldfolie, Silberfolie, matt weiß, gold und silber.

Colección de lámparas en metal hecho a mano, disponible acabado con: hoja de oro, hoja de plata, blanco opaco, oro y plata.

Коллекция ламп из металла изработанного вручную, доступный в отделках: золотой лист, серебрянный лист, белый матовый, золото и серебро.

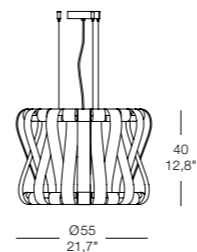

QUEEN M S055

1 x MAX 150W E27 alo. / inc.

o/or

1 x MAX 105W E27 alo.

o/or

1 x MAX 24W E27 PL-EL

CE IP 20

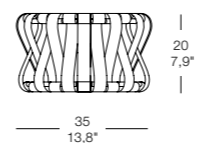

QUEEN M PA

2 x MAX 60W G9 halopin

o/or

2 x MAX 42W G9 alo.

CE IP 20

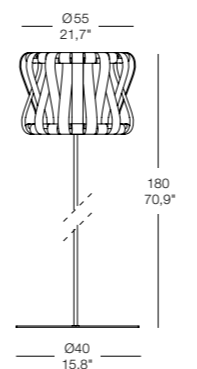

QUEEN M TE

1 x MAX 150W E27 alo. / inc.

o/or

1 x MAX 140W E27 alo.

CE IP 20

+ fall







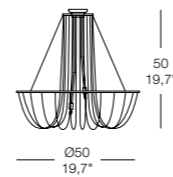





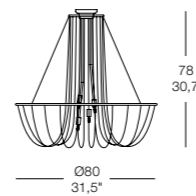

FALL PL50

3 x MAX 60W G9 halopin 
 o/or
 3 x MAX 42W G9 alo.  ENERGY SAVER
 CE  IP 20



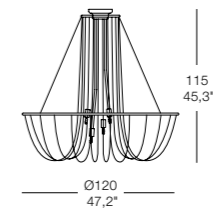

FALL PL80

6 x MAX 60W G9 halopin 
 o/or
 6 x MAX 42W G9 alo.  ENERGY SAVER
 CE  IP 20



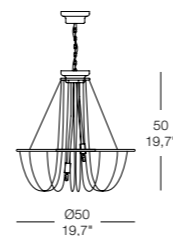

FALL PL120

6 x MAX 75W G9 halopin 
 o/or
 6 x MAX 42W G9 alo.  ENERGY SAVER
 CE  IP 20



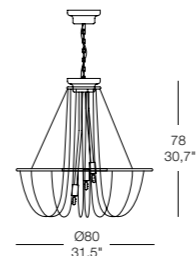

FALL S050

3 x MAX 60W G9 halopin 
 o/or
 3 x MAX 42W G9 alo.  ENERGY SAVER
 CE  IP 20



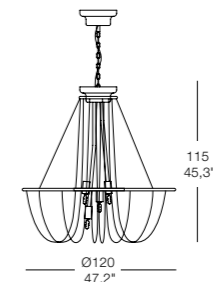

FALL S080

6 x MAX 60W G9 halopin 
 o/or
 6 x MAX 42W G9 alo.  ENERGY SAVER
 CE  IP 20



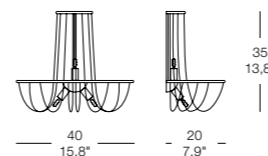

FALL S0120

6 x MAX 75W G9 halopin 
 o/or
 6 x MAX 42W G9 alo.  ENERGY SAVER
 CE  IP 20



FALL PA

3 x MAX 40W G9 halopin 
 o/or
 3 x MAX 33W G9 alo.  ENERGY SAVER
 CE  IP 20

FALL

technical detailed lists

design **Carmen Andretta**

Collezione di lampade in metallo cromato. Gli ornamenti sono disponibili nelle seguenti varianti: perla cristallo, perla nera, cristalli Swarovsky Strass e Spectra.

Collection of lamps in chrome-metal. Decorations available in the following options: crystal pearl, black pearl, Swarovsky crystals Strass and Spectra.

Collection de lampes en métal chromé. Ornaments disponibles dans les finitions suivantes: perle crystal, perle noire, Swarovsky crystals Strass et Spectra.

Kollektion von Leuchten aus Metall Chrom. Ornamente verfügbar in den Ausführungen: Kristallperle, schwarze Perle, Swarovsky Kristalle Strass und Spectra.

Colección de lámparas en metal cromado. Las decoraciones son disponibles en las siguientes opciones: perla cristal, perla negra, cristales Swarovsky Strass y Spectra.

Коллекция ламп из металла с хромированной отделкой. Украшения доступны в следующих вариантах: хрустальный жемчуг, чёрный жемчуг, хрустали Сваровский Страсс и Спектра.

+
york



YORK SO 50

EVISTYLE

248 / 249



DESIGN ANDREA LAZZARI

YORK TA



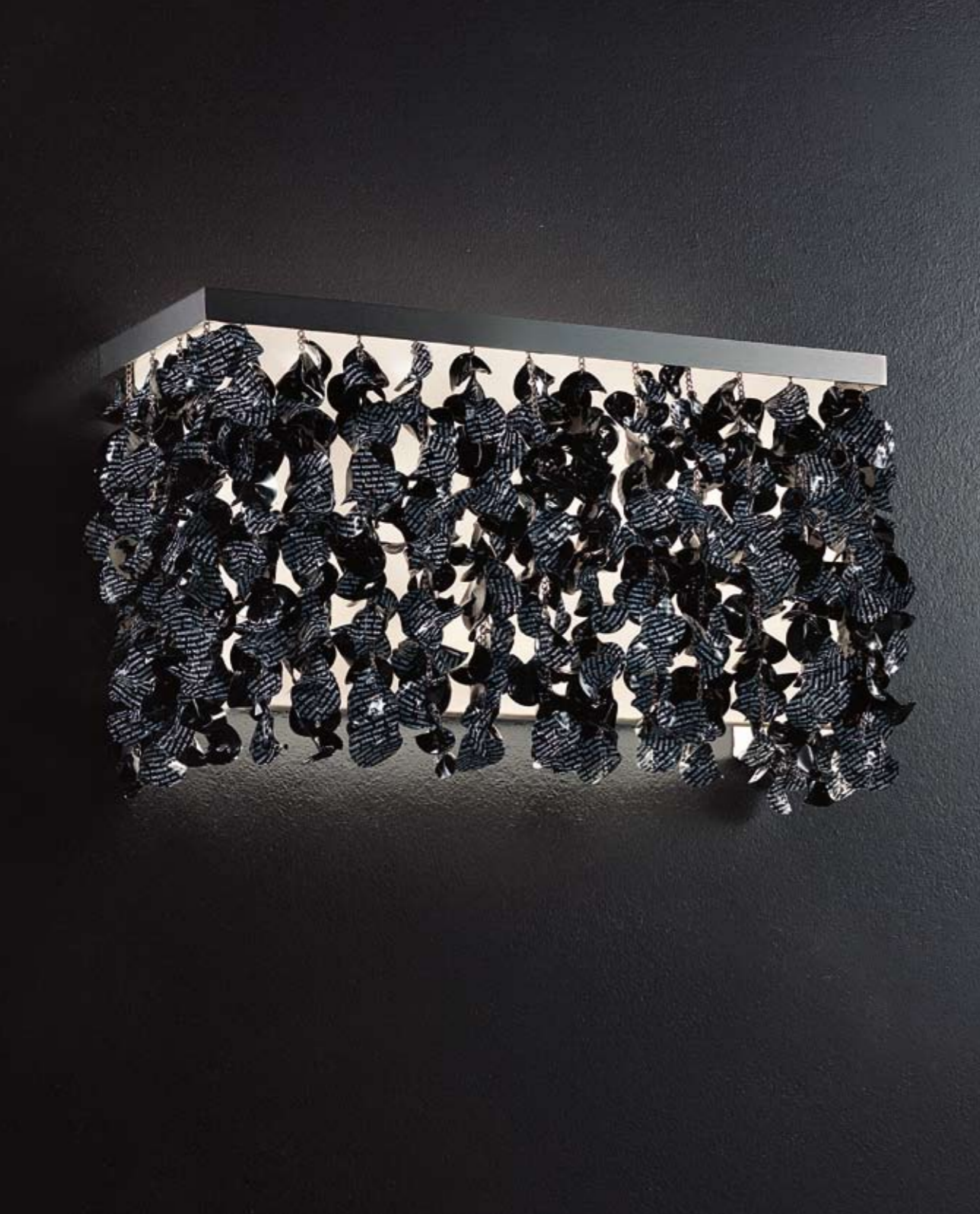

YORK PA 50 - YORK PA 35

EVISTYLE

252 / 253



DESIGN ANDREA LAZZARI

YORK SO 80

YORK

technical
detailed lists

design **andrea lazzari**

Collezione di lampade in metallo, disponibile nelle finiture oro satinato e nichel satinato. Gli accessori sono disponibili di serie nelle colorazioni: bianco perlato, oro opaco e cromo iridato. Su richiesta possono essere forniti nelle colorazioni: BT) bianco con testi in nero, NT) nero con testi in bianco e VI) viola iridato.

Collection of lamps in metal, available in the satin finishes gold and nickel. The accessories are available as standard in the colours: pearly white, matt gold and rainbow-coloured chrome. Upon request, they can be supplied in the colours: BT) white with black texts, NT) black with white texts and VI) rainbow-coloured violet.

Collection de lampes en metal, disponible dans les finitions satinées or et nickel. Les accessoires sont disponibles de serie dans les couleurs: blanc perlé, or opaque et chrome irisé. A la demande, ils peuvent être fourni dans les couleurs: BT) blanc avec textes noirs, NT) noir avec textes blancs et VI) violet irisé.



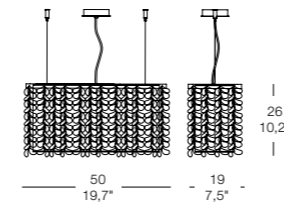

Kollektion von Leuchten aus Metall, verfügbar in den satinierten Ausführungen gold und Nickel. Die Zubehörteile sind serienmäßig verfügbar in den Farben: perlfarbig weiß, matt gold und regenbogenfarbig Chrom. Auf Wunsch sie können auch in den folgenden Farben geliefert: BT) weiß mit schwarzen Texten, NT) schwarz mit weißen Texten und VI) regenbogenfarbig violett.

Colección de lámparas en metal, disponible acabado con oro satinado y níquel satinado. Los accesorios son disponibles de serie en los colores: blanco perlado, oro opaco y cromo iridiscente. A solicitud pueden ser provistos en los colores: BT) blanco con textos en negro, NT) negro con textos en blanco y VI) morado iridiscente.

Коллекция ламп из металла, доступный в отделках сатинированное золото и сатинированный никель. Аксессуары доступны по серии в цветах: белый жемчуг, золотой матовый и радужный хром. По запросу могут быть в цветах: BT) белый с чёрными текстами, NT) чёрный с белыми текстами и, VI) радужно-фиолетовый.





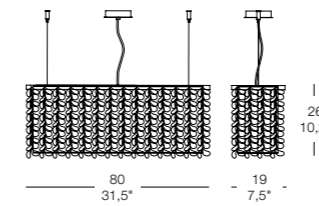

YORK SO 50

2 x MAX 75W E27 inc. 
 o/or
 2 x MAX 52W E27 alo.  ENERGY SAVER
 o/or
 2 x MAX 20W E27 PL-EL  ENERGY SAVING ES
 CE   IP 20





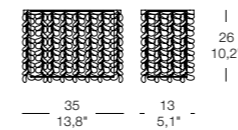

YORK SO 80

3 x MAX 75W E27 inc. 
 o/or
 3 x MAX 52W E27 alo.  ENERGY SAVER
 o/or
 3 x MAX 20W E27 PL-EL  ENERGY SAVING ES
 CE   IP 20





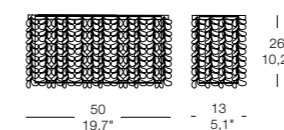

YORK PA 35

2 x MAX 60W E27 inc. 
 o/or
 2 x MAX 42W E27 alo.  ENERGY SAVER
 o/or
 2 x MAX 20W E27 PL-EL  ENERGY SAVING ES
 CE   IP 20





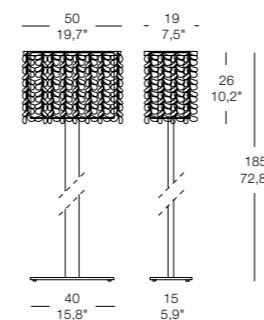

YORK PA 50

2 x MAX 75W E27 inc. 
 o/or
 2 x MAX 52W E27 alo.  ENERGY SAVER
 o/or
 2 x MAX 20W E27 PL-EL  ENERGY SAVING ES
 CE   IP 20





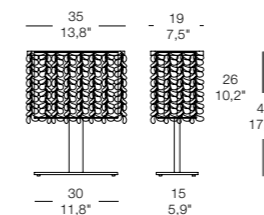

YORK TE

2 x MAX 75W E27 inc. 
 o/or
 2 x MAX 52W E27 alo.  ENERGY SAVER
 CE   IP 20



YORK TA

2 x MAX 75W E27 inc. 
 o/or
 2 x MAX 52W E27 alo.  ENERGY SAVER
 o/or
 2 x MAX 20W E27 PL-EL  ENERGY SAVING ES
 CE   IP 20

+ roll



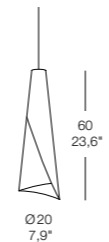

ROLL SO S/R

SOLO ONLY

1 x MAX 75W E27 PAR 30

o/or

1 x MAX 23W E27 PL-EL fluo

CE IP 20

SYSTEM 100 A

100 - 39,4" 3 - 1,2"

SYSTEM 150 A

150 - 59,1" 3 - 1,2"

CE IP 20

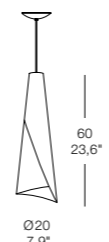

ROLL SO

SOLO ONLY

1 x MAX 75W E27 PAR 30

o/or

1 x MAX 23W E27 PL-EL fluo

CE IP 20

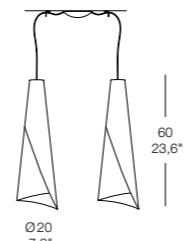

ROLL SO 2

SOLO ONLY

2 x MAX 75W E27 PAR 30

o/or

2 x MAX 23W E27 PL-EL fluo

CE IP 20

ROLL

technical
detailed lists

design **andrea lazzari**

Collezione di lampade in metallo e diffusore in lamina di PVC, disponibile nelle finiture oro satinato, rame satinato e acciaio satinato.

Collection of lamps in metal with shade in PVC lamina, available in the satin finishes gold, copper and steel.

Collection de lampes en metal et diffuseur en feuille de PVC, disponible dans les finitions satinées or, cuivre et acier.

Kollektion von Leuchten aus Metall und Diffusor aus PVC Lamina, verfügbar in den satinieren Ausführungen gold, Kupfer und Stahl.

Colección de lámparas en metal y difusor en lámina PVC, disponible acabado con oro satinado, cobre satinado y acero satinado.

Коллекция ламп из металла и отражатель из пластины из ПВХ, доступный в отделка сатинированное золото, сатинированное медь и сатинированный сталь.





+ romance

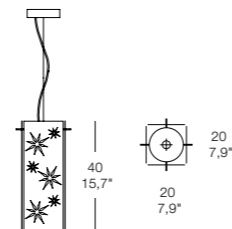







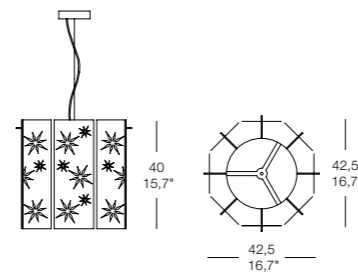

ROMANCE SO 15

1 x MAX 100W E27 alo. / inc. 
 o/or
 1 x MAX 70W E27 alo.  ENERGY SAVER
 o/or
 1 x MAX 23W E27 PL-EL  ENERGY SAVER
 CE  IP 20





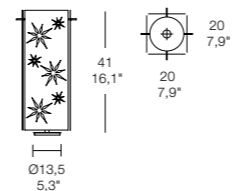

ROMANCE SO 40

1 x MAX 150W E27 alo. / inc. 
 o/or
 1 x MAX 105W E27 alo.  ENERGY SAVER
 o/or
 1 x MAX 21W E27 PL-EL  ENERGY SAVER
 CE  IP 20



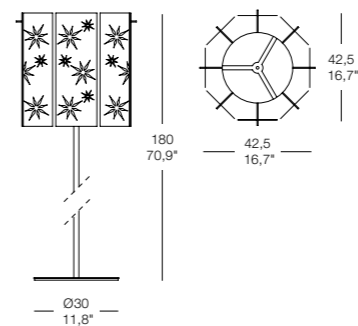

ROMANCE TA

1 x MAX 100W E27 alo. / inc. 
 o/or
 1 x MAX 70W E27 alo.  ENERGY SAVER
 o/or
 1 x MAX 23W E27 PL-EL  ENERGY SAVER
 CE  IP 20



ROMANCE TE

1 x MAX 150W E27 alo. / inc. 
 o/or
 1 x MAX 140W E27 alo.  ENERGY SAVER
 CE  IP 20

ROMANCE

technical detailed lists

design **andrea lazzari**

Collezione di lampade in metallo, disponibile nelle finiture: finitura bianco opaco con particolari in foglia argento o nero opaco con particolari in foglia oro.

Collection of lamps in metal, available in the finishes: matt white with details in silver leaf or matt black with details in gold leaf.

Collection de lampes en metal, disponible dans les finitions: blanc opaque avec details en feuille d'argent ou noir opaque avec details en feuille d'or.

Kollektion von Leuchten aus Metall, verfügbar in den Ausführungen: matt weiß mit Details aus Silberfolie oder matt schwarz mit Details aus Goldfolie.

Colección de lámparas en metal, disponible acabado: blanco opaco con detalles en hoja plata o negro opaco con detalles en hoja oro.

Коллекция ламп из металла, доступный в отделках: белый матовый с деталями из серебрянного листа или чёрный матовый с деталями из золотого листа.



+ curly

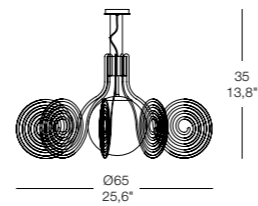

CURLY SO 65

1 x MAX 100W E27 inc. 

o/or

1 x MAX 70W E27 alo.  ENERGY SAVER

o/or

1 x MAX 23W E27 PL-EL  ENERGY SAVER

CE  IP 20

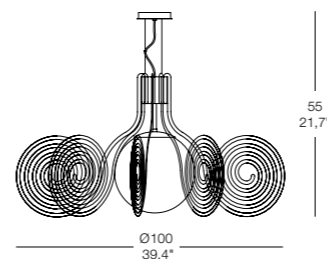

CURLY SO 100

1 x MAX 150W E27 inc. 

o/or

1 x MAX 105W E27 alo.  ENERGY SAVER

o/or

1 x MAX 23W E27 PL-EL  ENERGY SAVER

CE  IP 20

CURLY

technical
detailed lists

design **brian rasmussen**

Collezione di lampade in metallo nichel satinato, diffusore in vetro soffiato bianco latte satinato, particolari lavorati disponibili in metacrilato trasparente o nero lucido.

Collection of lamps in nickel metal satin-finish, shade in blown milk white glass satin-finish, details in methacrylate available in transparent or polish black colour.

Collection de lampes en nickel satiné, diffuseur en verre soufflé blanc lait satiné, détails en méthacrylate disponibles dans les couleurs transparent ou noir poli.

Kollektion von Leuchten aus Metall in der Ausführung Nickel satiniert, Diffusoren aus Mund geblasenem milchweißen Glas, Details verfügbar in Methacrylat transparent oder schwarz poliert.

Colección de lámparas en metal níquel satinado, difusor en cristal soplado blanco leche satinado, detalles en metacrilato disponibles en color transparente o negro lucido.

Коллекция ламп из металла с отделкой из сатинированного никеля, отражатель из выдувного стекла сатинированного молочно-белого цвета, детали доступны из прозрачного метакрилата или блестящего чёрного цвета.

+ groove





GROOVE Q 55



DESIGN ANDREA LAZZARI

GROOVE R 55



GROOVE Q 35

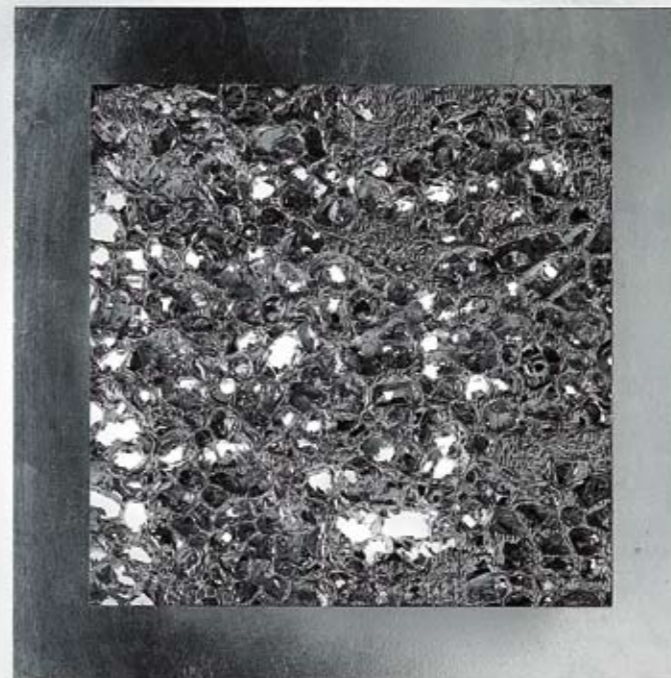

GROOVE Q 55

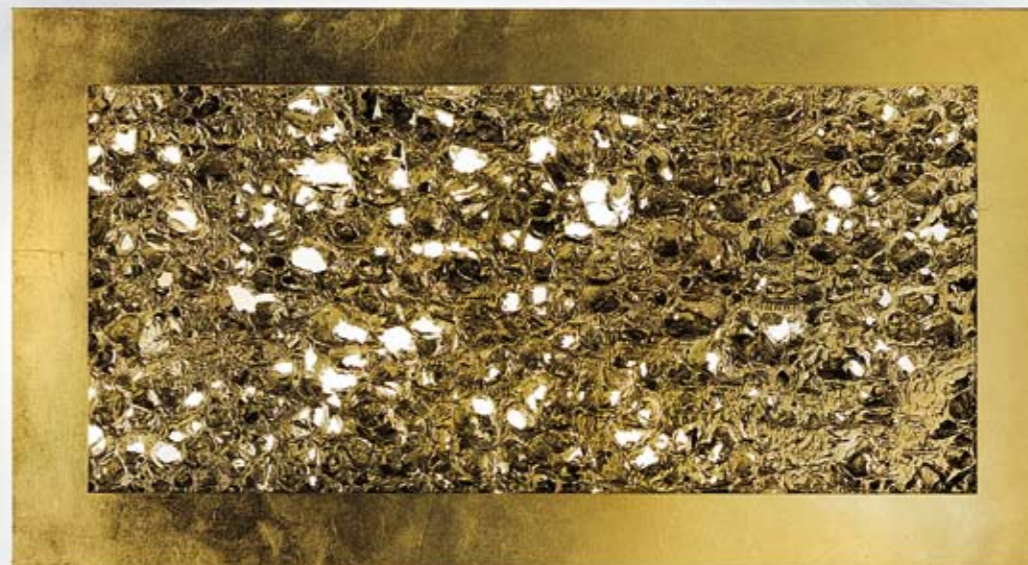

GROOVE R 55

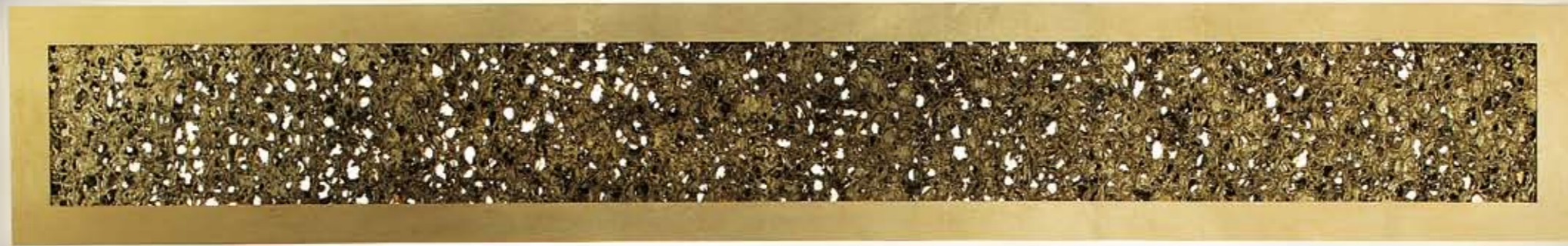

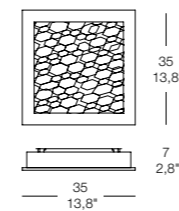



GROOVE Q 35

2 x MAX 18W 2G11 fluo 

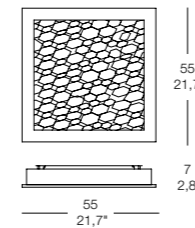
Ballast elettronico
Electronic ballast



GROOVE Q 55

4 x MAX 36W 2G11 fluo 

Ballast elettronico
Electronic ballast

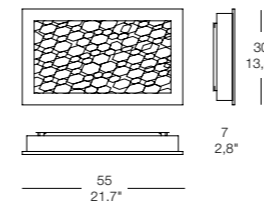

GROOVE R 55

2 x MAX 36W 2G11 fluo 

Ballast elettronico
Electronic ballast

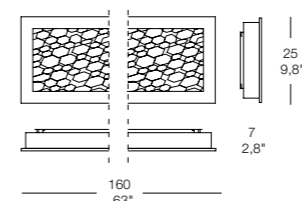

GROOVE R 160

2 x MAX 80W G5 fluo 

Ballast elettronico
Electronic ballast

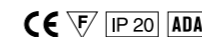

GROOVE

technical
detailed lists

design **Andrea Lazzari**

Collezione di lampade in metallo disponibile nelle finiture: foglia oro, foglia argento, foglia rame o bianco opaco; diffusore in schiuma di alluminio verniciata oro, argento o bianco opaco.

Collection of lamps in metal available in the finishes: gold leaf, silver leaf, copper leaf or matt white; shade in aluminium foam painted in gold or silver colour.

Collection de lampes en metal disponible dans les finitions: feuille d'or, feuille d'argent, feuille de cuivre or blanc opaque; diffuseur en écume d'aluminium teintée en couleur or ou argent.

Kollektion von Leuchten aus Metall verfügbar in den Ausführungen: Goldfolie, Silberfolie, Kupferfolie oder matt weiß; Diffusoren aus Aluminiumschaum lackiert in den Farben gold oder silber.

Colección de lámparas en metal disponible acabado con: hoja de oro, hoja de plata, hoja de cobre o blanco opaco; difusor en espuma de aluminio pintada oro, plata o blanco opaco.

Коллекция ламп из металла доступный в отделках: золотой лист, серебрянный лист, медянный лист или белый матовый, отражатель из алюминиевой пены раскрашена золотом, серебром или матовым белым.

+ tessuti





TESSUTI SO 30 MAXI

EVISTYLE

282 / 283



DESIGN SIMONE BELLAN

TESSUTI SO 90 MINI



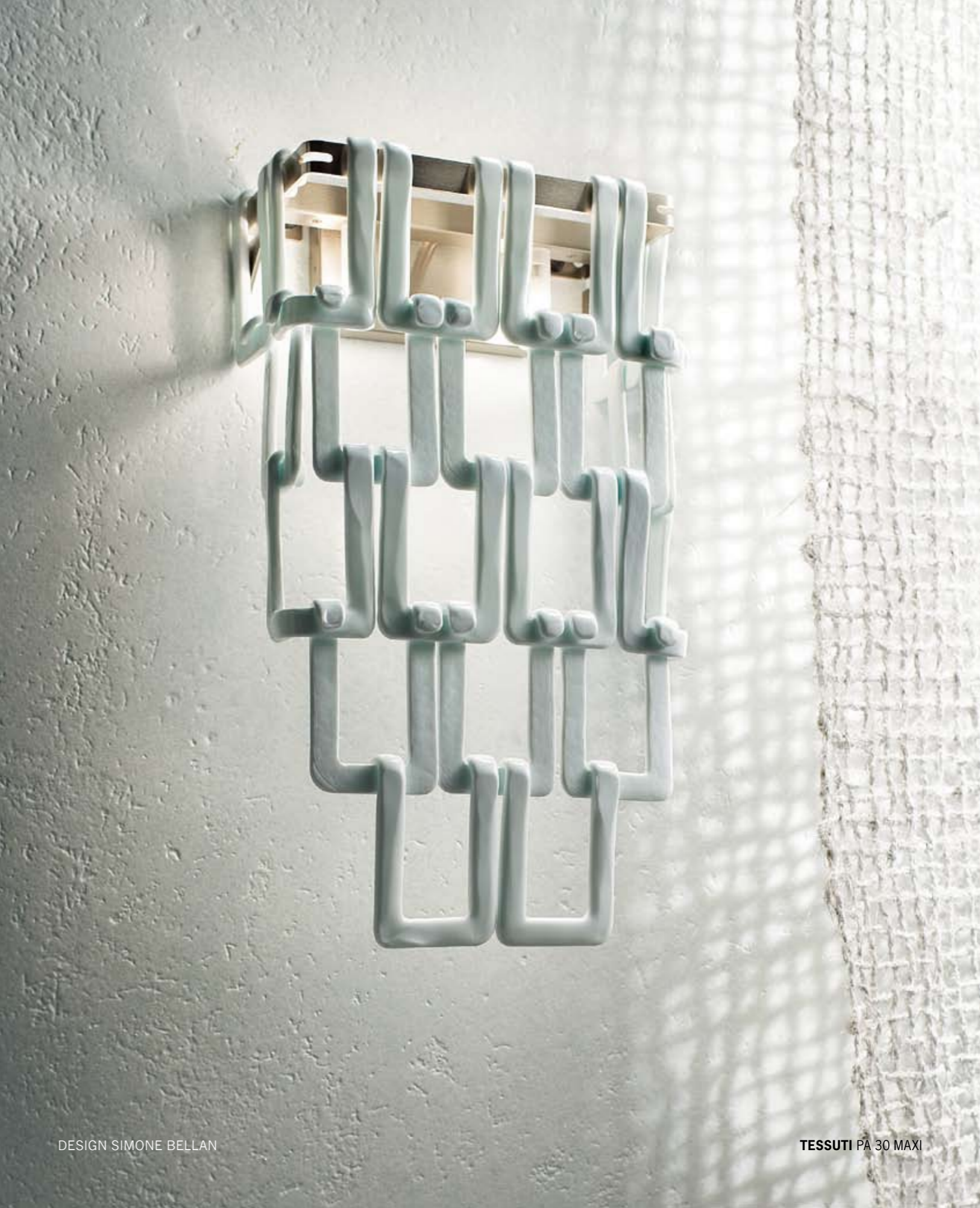

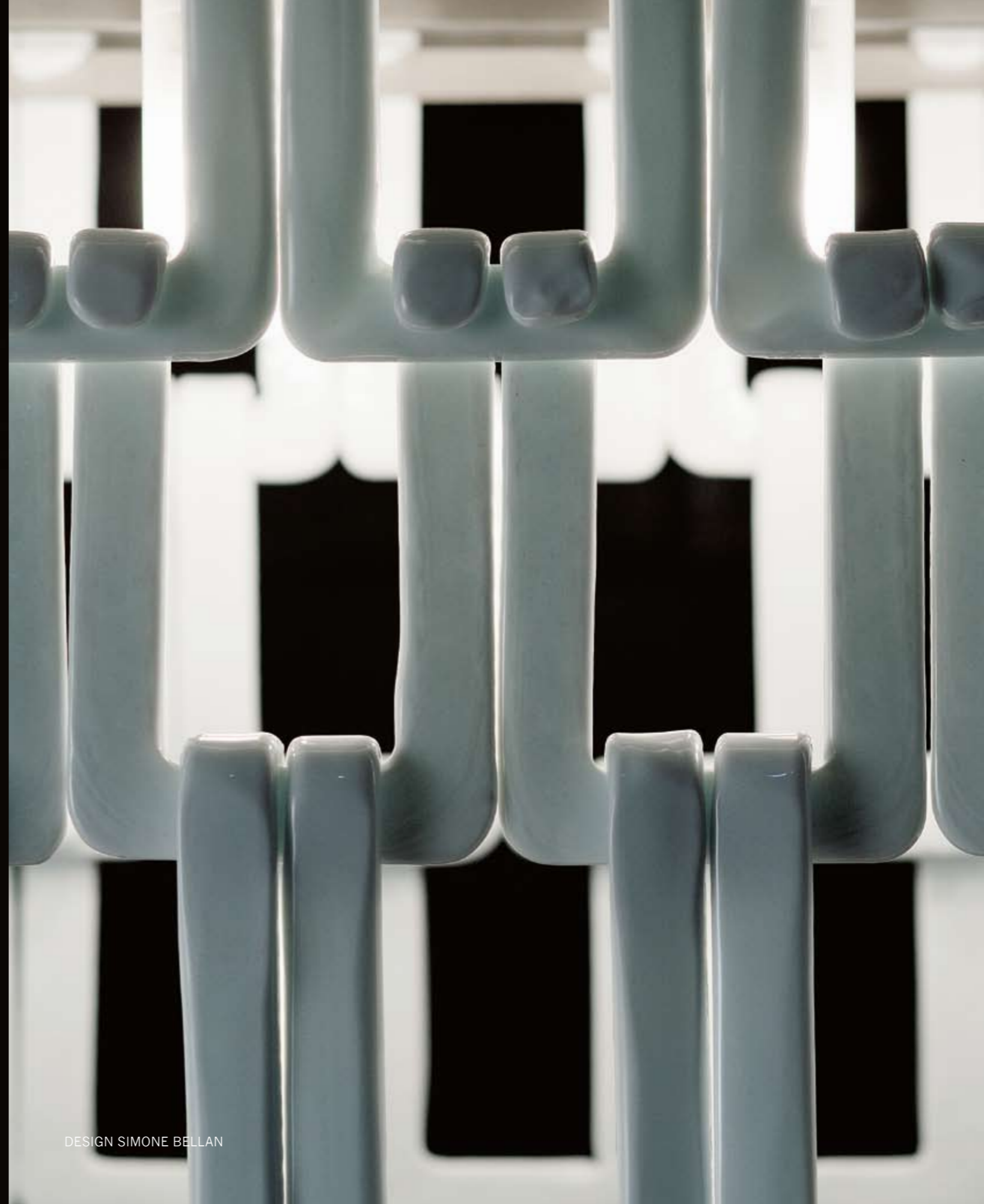



TESSUTI ESECUZIONE SPECIALE (vedi indicazioni a pag. 293)
TESSUTI SPECIAL FITTING (see indications at pag. 293)

EVISTYLE

290 / 291

DESIGN SIMONE BELLAN



esempi di possibili combinazioni
SOSPENSIONE - PLAFONIERA

examples of possible combinations
SUSPENSION - CEILING



300 x 30 cm - 118,10" x 11,8" dimensione struttura - frame dimension
312 x 35 cm - 122,8" x 13,8" dimensione struttura con vetri
 overall dimension with glasses

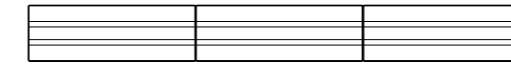

270 x 30 cm - 106,3" x 11,8" dimensione struttura - frame dimension
281 x 35 cm - 110,6" x 13,8" dimensione struttura con vetri
 overall dimension with glasses



240 x 30 cm - 94,5" x 11,8" dimensione struttura - frame dimension
251 x 35 cm - 98,8" x 13,8" dimensione struttura con vetri
 overall dimension with glasses

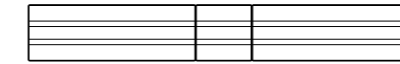

210 x 30 cm - 82,7" x 11,8" dimensione struttura - frame dimension
220 x 35 cm - 86,6" x 13,8" dimensione struttura con vetri
 overall dimension with glasses

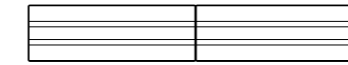

180 x 30 cm - 70,9" x 11,8" dimensione struttura - frame dimension
189 x 35 cm - 74,4" x 13,8" dimensione struttura con vetri
 overall dimension with glasses

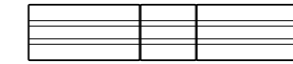

150 x 30 cm - 59" x 11,8" dimensione struttura - frame dimension
159 x 35 cm - 62,6" x 13,8" dimensione struttura con vetri
 overall dimension with glasses



120 x 30 cm - 47,2" x 11,8" dimensione struttura - frame dimension
128 x 35 cm - 50,4" x 13,8" dimensione struttura con vetri
 overall dimension with glasses

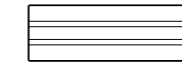

90 x 30 cm - 35,4" x 11,8" dimensione struttura - frame dimension
97 x 35 cm - 38,2" x 13,8" dimensione struttura con vetri
 overall dimension with glasses

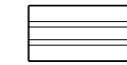

60 x 30 cm - 23,6" x 11,8" dimensione struttura - frame dimension
66 x 35 cm - 26" x 13,8" dimensione struttura con vetri
 overall dimension with glasses



30 x 30 cm - 11,8" x 11,8" dimensione struttura - frame dimension
35 x 35 cm - 13,8" x 13,8" dimensione struttura con vetri
 overall dimension with glasses

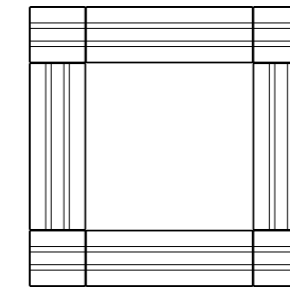

150 x 150 cm dimensione struttura
 59" x 59" frame dimension

159 x 159 cm dimensione struttura con vetri
 62,6" x 62,6" overall dimension with glasses

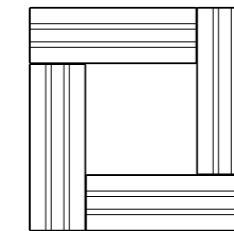

120 x 120 cm dimensione struttura
 47,2" x 47,2" frame dimension

128 x 128 cm dimensione struttura con vetri
 50,4" x 50,4" overall dimension with glasses

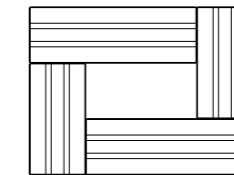

120 x 90 cm dimensione struttura
 47,2" x 35,4" frame dimension

128 x 97 cm dimensione struttura con vetri
 50,4" x 38,2" overall dimension with glasses

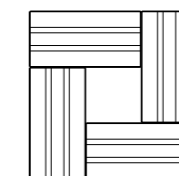

90 x 90 cm dimensione struttura
 35,4" x 35,4" frame dimension

97 x 97 cm dimensione struttura con vetri
 38,2" x 38,2" overall dimension with glasses

TESSUTI

technical
 detailed lists

design **simone bellan**

Collezione di lampade in metallo nichel satinato. I ganci in vetro sono eseguiti secondo le tecniche artistiche Muranesi, disponibili nelle colorazioni: cristallo trasparente, fumè, ambra e bianco lucido. Sono possibili combinazioni cromatiche di serie o su richiesta.

Collection of lamps in satinated nickel. The glass hooks are made according to the Murano artistic techniques, available in the colours: transparent crystal, smoke-grey, amber and polish white. They are available also with chromatic standard combinations or upon requests.

Collection de lampes en metal nickel satiné. Les crochets en verre sont réalisés selon les techniques artistiques de Murano, ils sont disponibles dans les couleurs: crystal transparent, fumé, amber et blanc brillant. Ils sont aussi disponibles avec compositions chromatiques standards ou sur demande.



Kollektion von Leuchten aus Metall Nickel satiniert. Die Glashaken sind realisiert nach den Murano artistischen Techniken und sind verfügbar in den Farben: chrystal transparent, Rauchgrau, amber und weiß glänzend. Sie sind verfügbar auch mit standard chromatischen Kombinationen oder nach Anfrage.

Colección de lamparas en metal niquel satinado. Los ganchos en vidrio son realizados según las técnicas artísticas de Murano, disponibles en los colores: cristal transparente, gris, ámbar y blanco lustroso. Son posibles combinaciones cromáticas de serie o a petición.

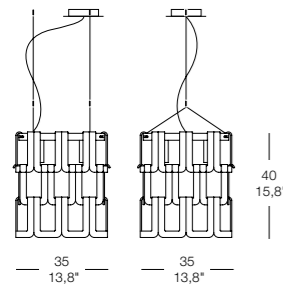
Коллекция ламп из металла сатиновый никель. Стеклопаянные крючки изготовлены согласно художественными техниками Мурано, доступные в цветах: прозрачный хрусталь, дымчатый и белый матовый. Возможны стандартные цветные сочетания или по заказу.



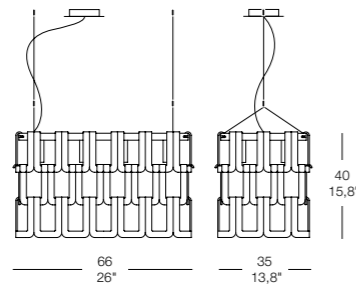

TESSUTI SO 30 MINI

4 x MAX 60W G9 halopin 
 o/or
 4 x MAX 42W G9 alo.  ENERGY SAVER



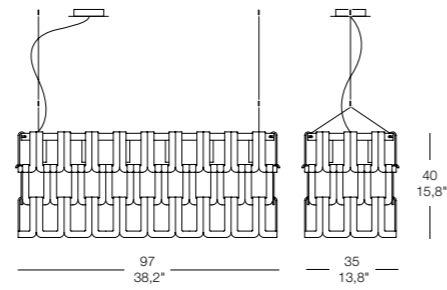

TESSUTI SO 60 MINI

8 x MAX 60W G9 halopin 
 o/or
 8 x MAX 42W G9 alo.  ENERGY SAVER



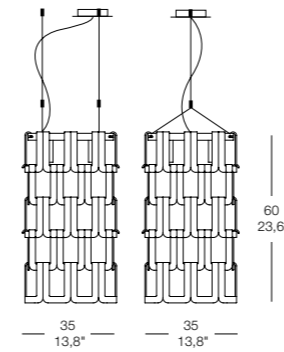

TESSUTI SO 90 MINI

12 x MAX 60W G9 halopin 
 o/or
 12 x MAX 42W G9 alo.  ENERGY SAVER



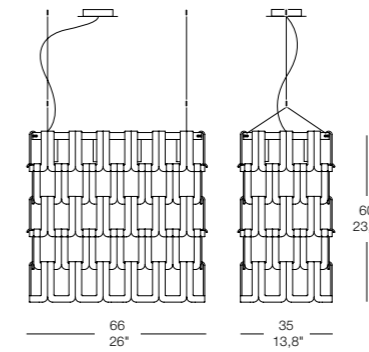

TESSUTI SO 30 MAXI

4 x MAX 60W G9 halopin 
 o/or
 4 x MAX 42W G9 alo.  ENERGY SAVER



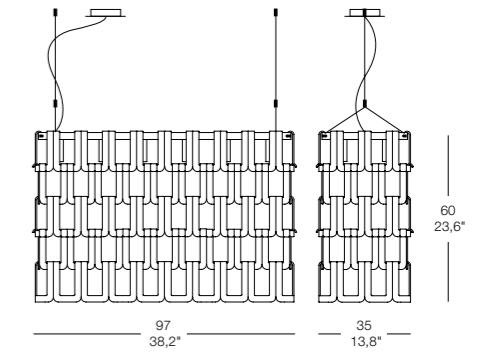

TESSUTI SO 60 MAXI

8 x MAX 60W G9 halopin 
 o/or
 8 x MAX 42W G9 alo.  ENERGY SAVER



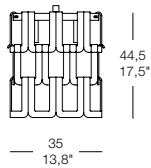

TESSUTI SO 90 MAXI

12 x MAX 60W G9 halopin 
 o/or
 12 x MAX 42W G9 alo.  ENERGY SAVER



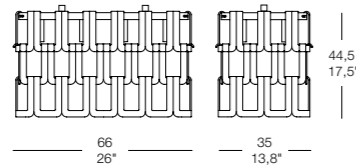

TESSUTI PL 30 MINI

4 x MAX 60W G9 halopin 
 o/or
 4 x MAX 42W G9 alo.  ENERGY SAVER



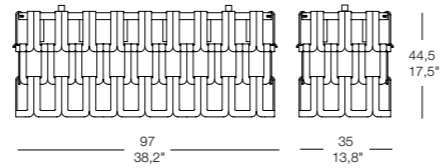

TESSUTI PL 60 MINI

8 x MAX 60W G9 halopin 
 o/or
 8 x MAX 42W G9 alo.  ENERGY SAVER



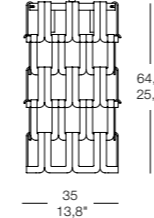

TESSUTI PL 90 MINI

12 x MAX 60W G9 halopin 
 o/or
 12 x MAX 42W G9 alo.  ENERGY SAVER



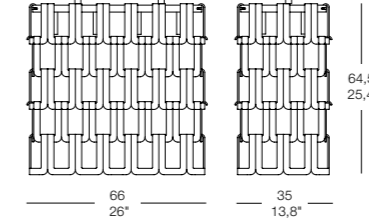

TESSUTI PL 30 MAXI

4 x MAX 60W G9 halopin 
 o/or
 4 x MAX 42W G9 alo.  ENERGY SAVER



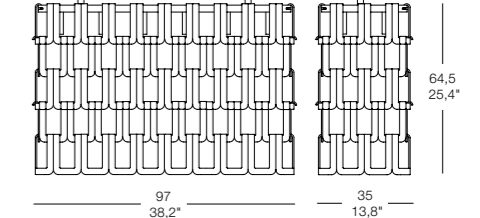

TESSUTI PL 60 MAXI

8 x MAX 60W G9 halopin 
 o/or
 8 x MAX 42W G9 alo.  ENERGY SAVER



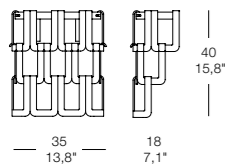

TESSUTI PL 90 MAXI

12 x MAX 60W G9 halopin 
 o/or
 12 x MAX 42W G9 alo.  ENERGY SAVER



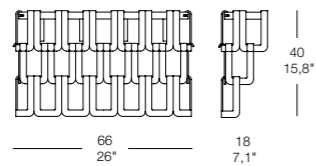

TESSUTI PA 30 MINI

2 x MAX 60W G9 halopin 
 o/or
 2 x MAX 42W G9 alo.  ENERGY SAVER



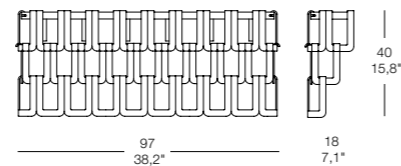

TESSUTI PA 60 MINI

4 x MAX 60W G9 halopin 
 o/or
 4 x MAX 42W G9 alo.  ENERGY SAVER



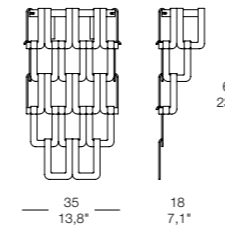

TESSUTI PA 90 MINI

6 x MAX 60W G9 halopin 
 o/or
 6 x MAX 42W G9 alo.  ENERGY SAVER



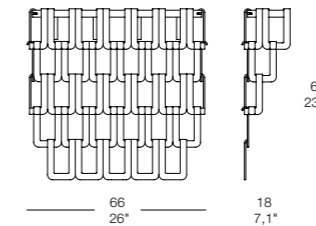

TESSUTI PA 30 MAXI

2 x MAX 60W G9 halopin 
 o/or
 2 x MAX 42W G9 alo.  ENERGY SAVER



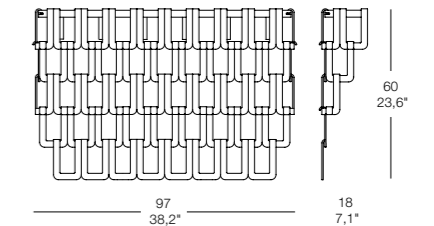

TESSUTI PA 60 MAXI

4 x MAX 60W G9 halopin 
 o/or
 4 x MAX 42W G9 alo.  ENERGY SAVER



TESSUTI PA 90 MAXI

6 x MAX 60W G9 halopin 
 o/or
 6 x MAX 42W G9 alo.  ENERGY SAVER



**SOSPENSIONE, PLAFONIERA
SUSPENSION, CEILING**

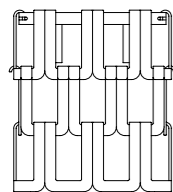

35 x 35 x h40 cm
13,8" x 13,8" x h15,8"

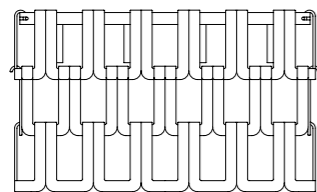

66 x 35 x h40 cm
26" x 13,8" x h15,8"

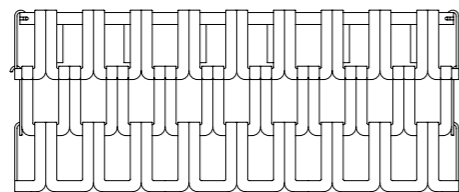

97 x 35 x h40 cm
38,2" x 13,8" x h15,8"

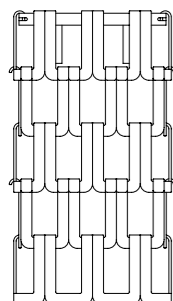

35 x 35 x h60 cm
13,8" x 13,8" x h23,6"

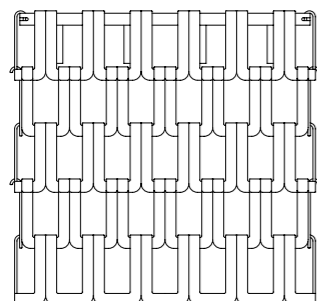

66 x 35 x h60 cm
26" x 13,8" x h23,6"

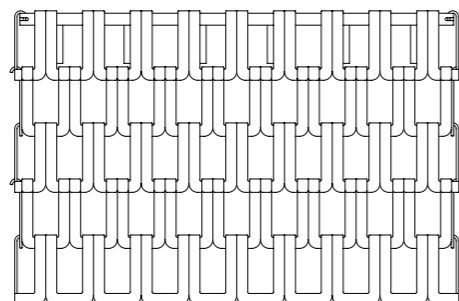

97 x 35 x h60 cm
38,2" x 13,8" x h23,6"

**MONOCROMATICO: CRISTALLO, AMBRA, FUMÉ, BIANCO
MONOCHROMATIC: CRYSTAL, AMBER, SMOKE-GREY, WHITE**

**SOSPENSIONE, PLAFONIERA
SUSPENSION, CEILING**

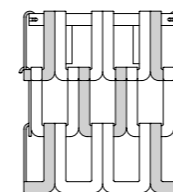

35 x 35 x h40 cm
13,8" x 13,8" x h15,8"

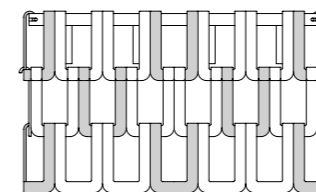

66 x 35 x h40 cm
26" x 13,8" x h15,8"

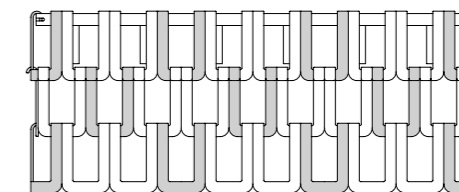

97 x 35 x h40 cm
38,2" x 13,8" x h15,8"

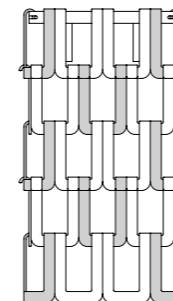

35 x 35 x h60 cm
13,8" x 13,8" x h23,6"

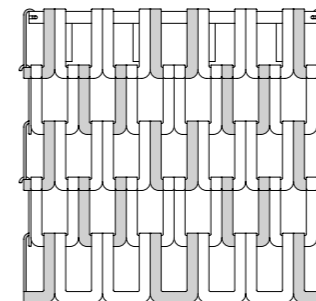

66 x 35 x h60 cm
26" x 13,8" x h23,6"

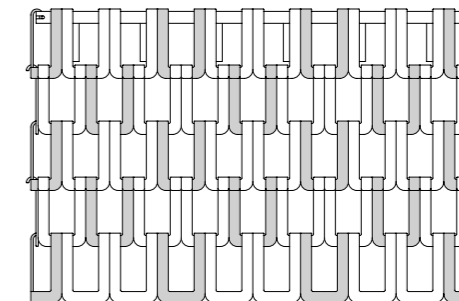

97 x 35 x h60 cm
38,2" x 13,8" x h23,6"

**INTRECCIO: AMBRA/CRISTALLO, FUMÉ/CRISTALLO
INTERWOVEN: AMBER/CRYSTAL, SMOKE-GREY/CRYSTAL**

**APPLIQUE
WALL BRACKET**

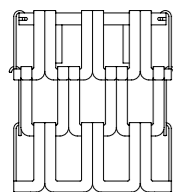

35 x 35 x h40 cm
13,8" x 13,8" x h15,8"

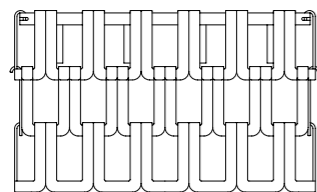

66 x 35 x h40 cm
26" x 13,8" x h15,8"

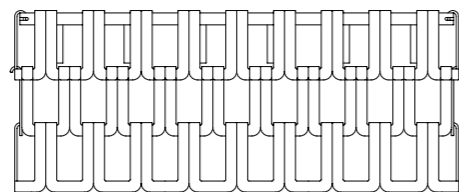

97 x 35 x h40 cm
38,2" x 13,8" x h15,8"

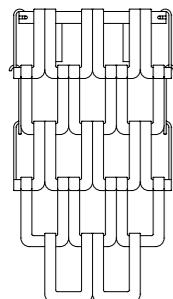

35 x 35 x h60 cm
13,8" x 13,8" x h23,6"

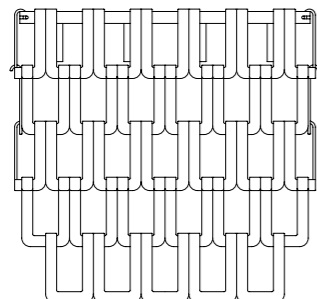

66 x 35 x h60 cm
26" x 13,8" x h23,6"

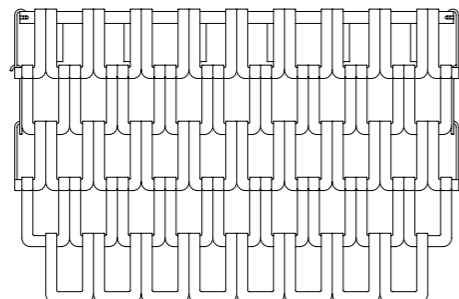

97 x 35 x h60 cm
38,2" x 13,8" x h23,6"

**MONOCROMATICO: CRISTALLO, AMBRA, FUMÉ, BIANCO
MONOCHROMATIC: CRYSTAL, AMBER, SMOKE-GREY, WHITE**

**APPLIQUE
WALL BRACKET**

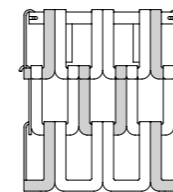

35 x 35 x h40 cm
13,8" x 13,8" x h15,8"

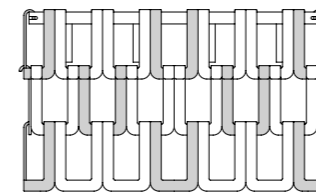

66 x 35 x h40 cm
26" x 13,8" x h15,8"

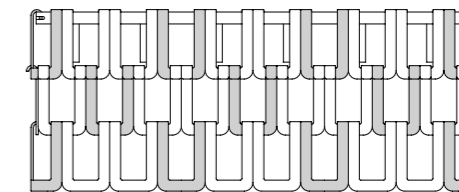

97 x 35 x h40 cm
38,2" x 13,8" x h15,8"

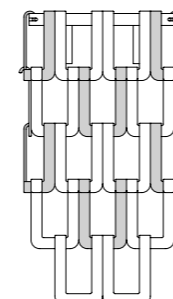

35 x 35 x h60 cm
13,8" x 13,8" x h23,6"

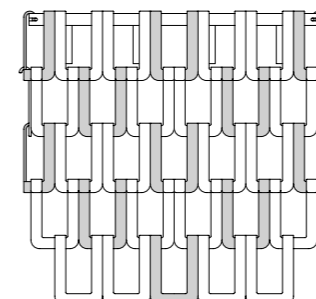

66 x 35 x h60 cm
26" x 13,8" x h23,6"

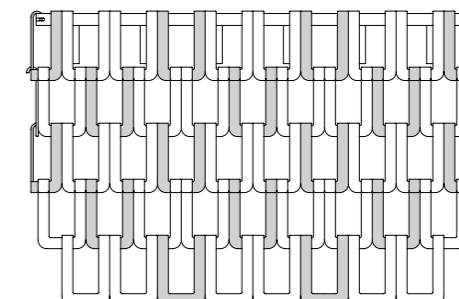

97 x 35 x h60 cm
38,2" x 13,8" x h23,6"

**INTRECCIO: AMBRA/CRISTALLO, FUMÉ/CRISTALLO
INTERWOVEN: AMBER/CRYSTAL, SMOKE-GREY/CRYSTAL**

SOSPENSIONE, PLAFONIERA
SUSPENSION, CEILING

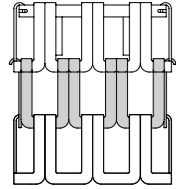

35 x 35 x h40 cm
13,8" x 13,8" x h15,8"

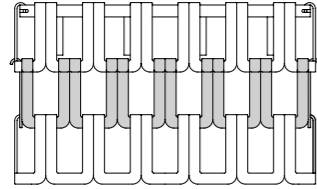

66 x 35 x h40 cm
26" x 13,8" x h15,8"

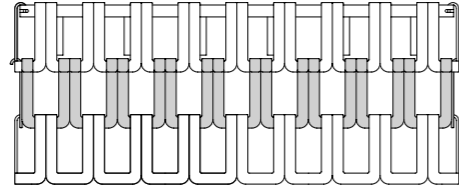

97 x 35 x h40 cm
38,2" x 13,8" x h15,8"

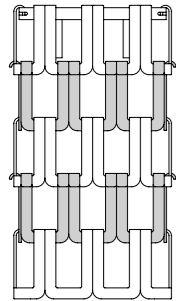

35 x 35 x h60 cm
13,8" x 13,8" x h23,6"

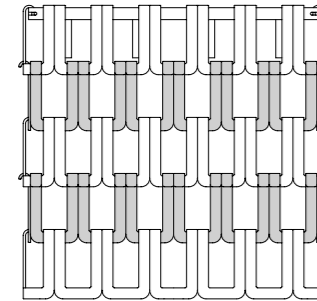

66 x 35 x h60 cm
26" x 13,8" x h23,6"

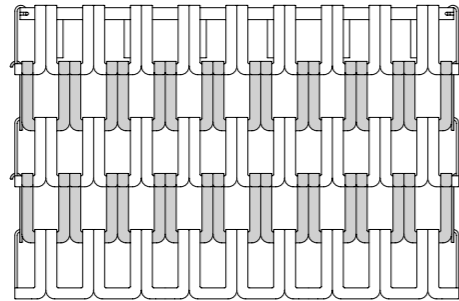

97 x 35 x h60 cm
38,2" x 13,8" x h23,6"

SOSPENSIONE, PLAFONIERA
SUSPENSION, CEILING

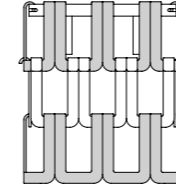

35 x 35 x h40 cm
13,8" x 13,8" x h15,8"

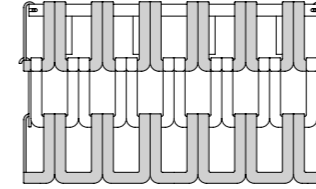

66 x 35 x h40 cm
26" x 13,8" x h15,8"

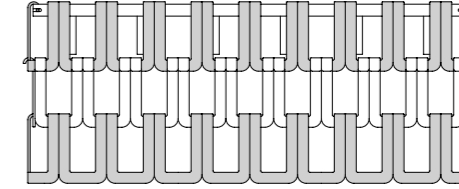

97 x 35 x h40 cm
38,2" x 13,8" x h15,8"

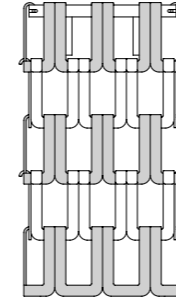

35 x 35 x h60 cm
13,8" x 13,8" x h23,6"

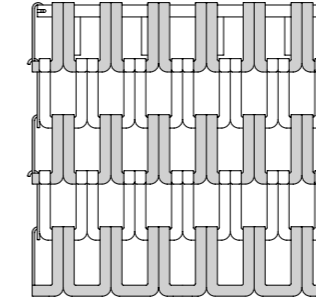

66 x 35 x h60 cm
26" x 13,8" x h23,6"

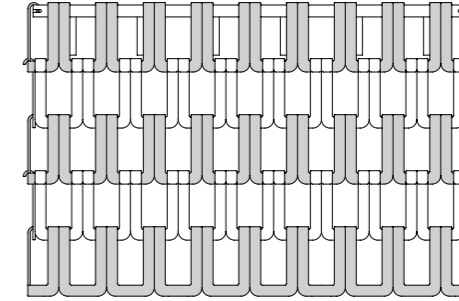

97 x 35 x h60 cm
38,2" x 13,8" x h23,6"

APPLIQUE
WALL BRACKET

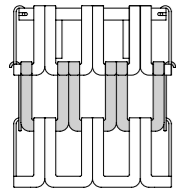

35 x 35 x h40 cm
13,8" x 13,8" x h15,8"

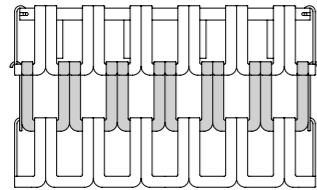

66 x 35 x h40 cm
26" x 13,8" x h15,8"

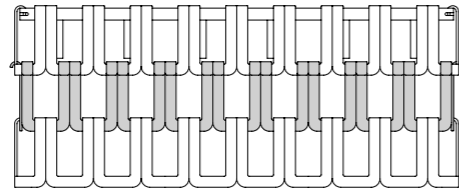

97 x 35 x h40 cm
38,2" x 13,8" x h15,8"

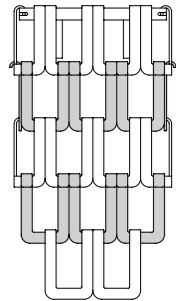

35 x 35 x h60 cm
13,8" x 13,8" x h23,6"

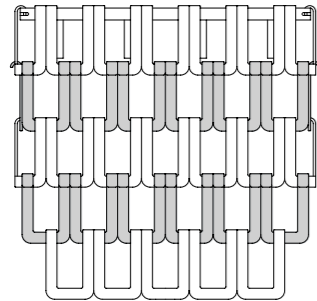

66 x 35 x h60 cm
26" x 13,8" x h23,6"

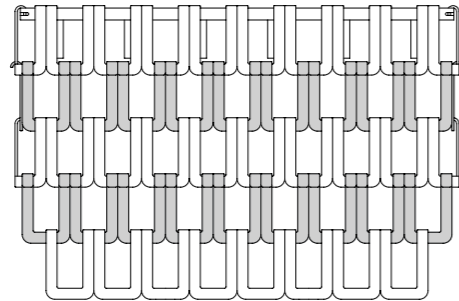

97 x 35 x h60 cm
38,2" x 13,8" x h23,6"

BICROMATICO A: CRISTALLO/AMBRA, CRISTALLO/FUMÉ
BICOLOUR A: CRYSTAL/AMBER, CRYSTAL/SMOKE-GREY

APPLIQUE
WALL BRACKET

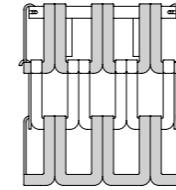

35 x 35 x h40 cm
13,8" x 13,8" x h15,8"

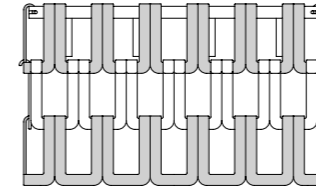

66 x 35 x h40 cm
26" x 13,8" x h15,8"

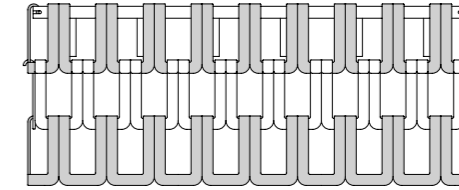

97 x 35 x h40 cm
38,2" x 13,8" x h15,8"

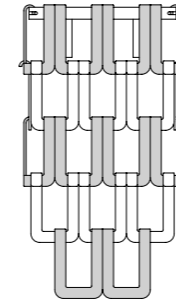

35 x 35 x h60 cm
13,8" x 13,8" x h23,6"

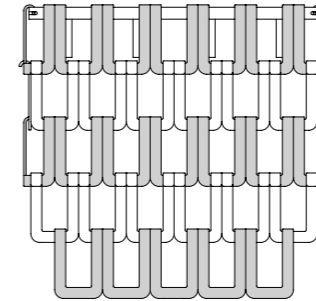

66 x 35 x h60 cm
26" x 13,8" x h23,6"

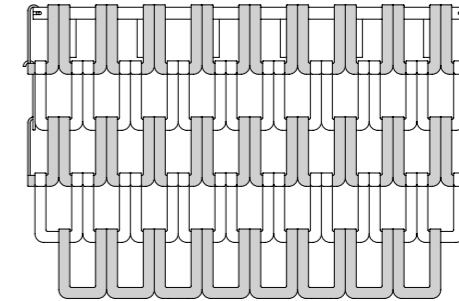

97 x 35 x h60 cm
38,2" x 13,8" x h23,6"

BICROMATICO B: AMBRA/CRISTALLO, FUMÉ/CRISTALLO
BICOLOUR B: AMBER/CRYSTAL, SMOKE-GREY/CRYSTAL

ALASKA
pag. 96

ASIA
pag. 108

BROADWAY
pag. 132

BUTTERFLY
pag. 150

CLUB
pag. 118

COOL
pag. 100

DIAMOND
pag. 18

DICE
pag. 50

DRESS
pag. 140

DRESS R
pag. 122

EGG
pag. 158

EYE
pag. 168

EVO
pag. 164

FLAT Q-R-PP
pag. 72

**LAMPADA
DA PARETE**
WALL BRACKET

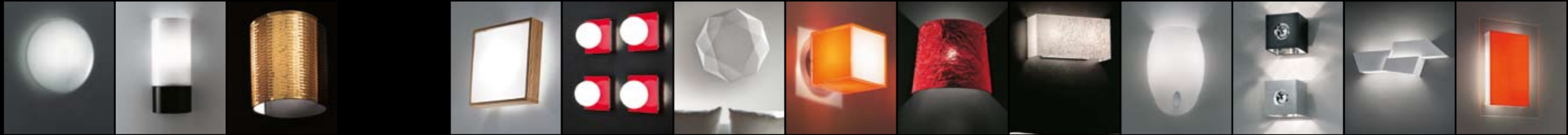

**LAMPADA
DA PLAFONE**
CEILING LAMP



**LAMPADA
DA SOSPENSIONE**
SUSPENSION



**LAMPADA
DA TERRA**
FLOOR LAMP



**LAMPADA
DA TAVOLO/
COMODINO**
TABLE LAMP/
NIGHT TABLE LAMP



**LAMPADA
DA INCASSO**
RECESSED SPOT

MOROSINI
luce & design

FLORIAN
pag. 56

FOG
pag. 38

FUNZIONE
pag. 200

GIGLIO
pag. 82

NEMESI
pag. 178

RIBBON
pag. 62

ROUND
pag. 88

SKETCH
pag. 172

SPRING
pag. 26

SUNRISE
pag. 186

WASHI
pag. 12

WAVE
pag. 114

YOUNG + MINI
pag. 154

ZEUS
pag. 194

**LAMPADA
DA PARETE**
WALL BRACKET



**LAMPADA
DA PLAFONE**
CEILING LAMP



**LAMPADA
DA SOSPENSIONE**
SUSPENSION



**LAMPADA
DA TERRA**
FLOOR LAMP



**LAMPADA
DA TAVOLO/
COMODINO**
TABLE LAMP/
NIGHT TABLE LAMP



**LAMPADA
DA INCASSO**
RECESSED SPOT



MOROSINI
luce & design

CURLY
pag. 266

FALL
pag. 238

FRISÈ + MINI
pag. 220

GROOVE
pag. 270

QUEEN M
pag. 230

RETRÒ + SOFT
pag. 210

ROLL
pag. 256

ROMANCE
pag. 260

SYMPHONY
pag. 204

TESSUTI
pag. 280

YORK
pag. 246

**LAMPADA
DA PARETE**
WALL BRACKET

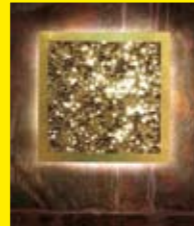

**LAMPADA
DA PLAFONE**
CEILING LAMP



**LAMPADA
DA SOSPENSIONE**
SUSPENSION

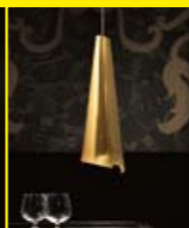

**LAMPADA
DA TERRA**
FLOOR LAMP



**LAMPADA
DA TAVOLO/
COMODINO**
TABLE LAMP/
NIGHT TABLE LAMP



**LAMPADA
DA INCASSO**
RECESSED SPOT

EviStyle[®]
Passion for light

LEGENDA



Tutte le lampade sono costruite secondo le norme europee EN 60598-1 e con materiali approvati da vari istituti di sicurezza.

All the lamps are made according to European standards EN 60598-1 and of materials approved by various safety institutes.



Apparecchio predisposto per il montaggio su superfici infiammabili.

Fixture ready for mounting on inflammable surfaces.



Apparecchio in classe II - Apparecchio nel quale la protezione contro la scossa elettrica non si basa unicamente sull'isolamento fondamentale, ma anche sulle misure supplementari di sicurezza costituite dal doppio isolamento o dall'isolamento rinforzato. Queste misure non comportano dispositivi per la messa a terra e non dipendono dalle condizioni d'installazione.

Class II appliance - appliance in which protection against electric shock is not only based on basic insulation, but also on additional safety measures, i.e. double insulation or reinforced insulation. These measures do not involve earthing devices and do not depend on the installation conditions.



Risparmio di energia.

Energy saving.

Grado di protezione - Stabilisce un sistema per la classificazione degli apparecchi elettrici in base al grado di protezione fornito dagli involucri degli stessi.

I simboli utilizzati per indicare questo grado di protezione sono costituiti dalle lettere "IP" seguite da due cifre caratteristiche:

- la prima cifra indica la protezione contro la penetrazione dei corpi solidi e della polvere;

- la seconda cifra indica la protezione contro la penetrazione dei liquidi.

IP

Protection level - This establishes a classification system for electric appliances based on the protection level supplied by their casing.

The symbols used to indicate the level of protection are the two letters, "IP" followed by two figures.

- The first figure indicates the protection against penetration by solid bodies and dust;

- The second figure indicates the protection against penetration by liquids.

Gradi di protezione IP - Protection degrees (IP)

1ª cifra protezione alla penetrazione di corpi solidi.
1st figure: protection against penetration by solid bodies.

0

Non Protetto.
No protection.

1

Protetto da corpi solidi superiori a 50 mm.
Protected against solid matters (over 50 mm.).

2

Protetto da corpi solidi superiori a 12 mm.
Protected against solid matters (over 12 mm.).

3

Protetto da corpi solidi superiori a 2,5 mm.
Protected against solid matters (over 2,5 mm.).

4

Protetto da corpi solidi superiori a 1 mm.
Protected against solid matters (over 1 mm.).

5

Protetto contro la polvere.
Dust proof.



6

Totalmente protetto contro la polvere.
Fully dust.



2ª cifra protezione contro la penetrazione d'acqua.
2nd figure: protection against penetration by water.

0

Non Protetto.
No protection.

1

Protetto contro lo stillicidio.
Protected proof fixture.



2

Protetto da cadute d'acqua, inclinazione di 15.
Protected against water falling at 15 angle.

3

Protetto contro la pioggia.
Rain proof fixture.



4

Protetto contro gli spruzzi.
Splash proof fixture.



5

Protetto contro getti d'acqua.
Water jet proof.



6

Protetto contro le ondate.
Wave proof.

ENERGY SAVER

DIRETTIVA EUP - ENERGY SAVER

Il regolamento comunitario 244/2009 del 18 marzo 2009 prevede l'uscita di produzione delle lampadine a incandescenza in 6 fasi successive, dal 1° settembre 2009 al 1° settembre 2016.

In ottemperanza a tale regolamento, si è reso necessaria l'implementazione nel nostro catalogo e listino delle indicazioni di lampadine di nuova generazione (indicate dal marchio ENERGY SAVER).

Tali lampadine consentono i seguenti benefici:

- minore consumo di energia elettrica (- 30%)
- maggiore durata delle ore di vita
- flusso luminoso costante per tutta la durata di vita della lampadina
- minore produzione di calore

EUP REGULATION- ENERGY SAVER

According to the commission regulation (EC) No 244/2009 dated 18th March 2009, incandescent light-bulbs will be removed from the market in 6 steps from 1st September 2009 to 1st September 2016.

Therefore, in compliance with this regulation, the new generation light-bulbs will be indicated in our catalogue and price list as ENERGY SAVER.

These light-bulbs have the following benefits:

- lower consumption of electric power (-30%)
- longer duration
- constant luminous flux
- less heat emission

DIRECTIVE EUP – ENERGY SAVER

Le règlement CE nr. 244/2009 du 18 mars 2009 prévoit que, en 6 phases successives du 1er septembre 2009 jusqu'au 1er septembre 2016, les lampes à incandescence ne seront plus produites.

Conformément a ce règlement, dans notre catalogue ainsi que dans notre tarif seront données les indications sur les lampes économiques de nouvelle generation (indiquées avec le marque ENERGY SAVER).

Ces ampoules donnent les avantages suivants:

- Moindre consommation d'électricité (- 30%)
- Durée de vie plus longue
- Flux lumineux constant pour toute la durée de vie de l'ampoule
- Moindre production de chaleur

RICHTLINIE EUP – ENERGY SAVER

Nach der EU Verordnung Nr. 244/2009 vom 18. März 2009, von 1. September 2009 bis 1. September 2016 in 6 folgenden Phasen, werden die Standardglühlampen nicht mehr weiter hergestellt.

Dieser Verordnung gemäß, werden die Anzeigen über die Energiesparlampen der neuen Generation (gekennzeichnet mit dem Zeichen ENERGY SAVER) in unserem Katalog sowie in unserer Preislisten mitgegeben.

Diese Energiesparlampen bieten folgende Vorteile an:

- weniger an Leistung aufnehmen (- 30%)
- längere Lebensdauer
- regelmäßige Lichtstrom während der ganzen Lebensdauer
- weniger Hitze

REGLAMENTO EUP- ENERGY SAVING

Según el reglamento comunitario 244/2009 aprobado en fecha 18 marzo 2009, las bombillas incandescentes saldrán gradualmente de producción en 6 fases desde el 1 de septiembre 2009 hasta el 1 de septiembre 2016.

En conformidad con esta norma, ha sido necesario añadir en nuestro catálogo y tarifa indicaciones de las bombillas de nueva generación (señaladas como ENERGY SAVING)

Los beneficios de estas bombillas son los siguientes:

- menor consumo de energía eléctrica (-30%)
- mayor duración
- flujo luminoso constante
- menor producción de calor

ЕВРОПЕЙСКАЯ ПРОГРАММА ПО ЭНЕРГОСБЕРЕЖЕНИЮ

Согласно постановлению комиссии (ЕС) № 244/2009 от 18.03.2009, производство лампочек накаливания будет прекращаться в 6 этапов с 01.09.2001 до 01.09.2016.

В соответствии с этим постановлением, лампочки нового поколения будут обозначены в нашем каталоге и прейскуранте как ЭНЕРГОСБЕРЕГАЮЩИЕ.

Особенности энергосберегающих лампочек:

- низкое потребление электроэнергии (до 30%)
- более продолжительный срок службы
- постоянный люминесцентный поток
- низкая температура нагрева

Associato
Associate

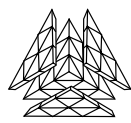

assoLuce

Associazione nazionale
delle imprese degli apparecchi
di illuminazione



UNINDUSTRIA
VENEZIA



Ente Aderente
Al Consorzio Veneto Per I Sistemi
Dell'illuminazione