















technical 2020



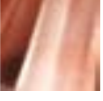

Finiture - Finishes

 .00 Trasparente Transparent	 .31 Cromato Chromed	 .45 Alluminio anodizzato Aluminium anodized
 .01 Bianco White	 .32 Nichel satinato Nickel mat	 .50 Cristallo Crystal
 .02 Nero Black	 .33 Acciaio satinato Matt-steel	 .57 Vetro bianco White glass
 .03 Grigio Grey	 .34 Verniciato corten Painted corten finishing	
 .21 Dorato lucido Shiny gold	 .38 Ramato lucido Shiny copper	
 .25 Dorato satinato Satin gold	 .39 Verniciato antracite Painted anthracite finishing	

Codice colore luce Light Color Codes

- /XW** Extra White LED 2700K
- /WW** Warm White LED 3000K
- /W** Natural White LED 4000K
- /CW** Cold White LED 5000K
- /RGB** RGB LED 
- /B** Blue LED

Codice versioni - Option Codes

- /EM** Emergenza
Emergency
- /DIM** Dimmerabile
Dimming 
- /DALI** Dimmerabile
Dimming 
- /ST** Con diffusore satinato
Satin diffuser
- /TR** Con diffusore trasparente
Transparent diffuser
- /P** Con protezione IP 44
IP 44 protection

I valori di lumen (lm) riportati si riferiscono al flusso luminoso nominale della sorgente LED
The values of lumens (lm) indicated referring to the nominal luminous flux of the LED source

www.egoluce.com

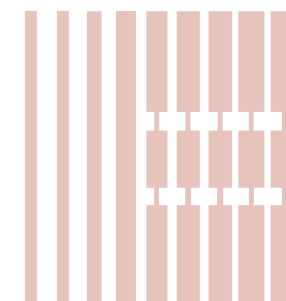



LA NOSTRA MISSIONE: MADE IN ITALY

Da sempre l'Italia è la culla della creatività. Know-how e stile italiano sono identificati e apprezzati ovunque, tanto che il marchio Made in Italy ha sempre costituito un valore aggiunto ricercato in tutto il mondo.

Il prodotto italiano può essere immediatamente riconosciuto grazie ai dettagli, all'attenzione e ai valori estetici che sono da sempre il nostro biglietto da visita.

Sulla scia di questa grande tradizione, dal 1978 EGOLUCE crea prodotti 100% Made in Italy, collaborando principalmente con aziende e artigiani italiani: per offrire ai propri clienti un prodotto di design con i più alti standard tecnologici.

La scelta diligente e attenta dei componenti e dei materiali di migliore qualità e la lavorazione guidata da criteri di qualità totale, ci consente di produrre e offrire ai nostri clienti una vasta gamma di corpi illuminanti per diverse applicazioni.

Le soluzioni di progettazione illuminotecnica qualificate identificano EgoLuce come uno dei più importanti produttori mondiali di illuminazione.

Prodotti 100% Made in Italy.

40 ANNI DI SUCCESSO

EgoLuce: 40 anni di esperienza per la tua illuminazione su misura.

L'evoluzione del prodotto combinato con nuovi materiali, tecnologie e design, sono i reali risultati delle nostre collezioni.

Il know-how e la cura dei dettagli in ogni fase della produzione sono stati una forza costante in questi 40 anni di attività di successo.

La capacità nella risoluzione dei problemi, l'attenzione al cliente e a ogni singola domanda del mercato, sono una missione costante per Tutti noi!

APPROCCIO UMANO

I sistemi di controllo degli apparecchi considerano il bioritmo umano e incidono positivamente sulla salute e sul benessere.

Un'intelligente gestione dell'energia e del colore della luce danno la possibilità di creare nuovi spazi nel vuoto, regalando allo spettatore una diversa visione dello spazio.

Una nuova esperienza sensoriale per la tua anima.

Una luce capace di muoversi e variare nello spazio, in grado di fondersi, di stupire e di appassionare: una luce indimenticabile.

La luce vive nell'ombra perché il suo flusso è regolato da soluzioni accattivanti in ogni versione.



OUR MISSION: MADE IN ITALY

Since ever Italy is the cradle of creativity.

An aware production know how and style are identified and commended throughout the world, so much so that the Made in Italy mark has always constituted sought-after an added value.

An Italian product can immediately be recognized: details, attention and the aesthetic values are their business card.

In the wake of this great tradition, since 1978 EGOLUCE has been creating 100% Made in Italy products, mostly collaborating with Italian companies and craftsmen: in order to offer its clients a design product with highest technology standard.

The diligent and careful selection of best quality components and materials and the processing guided by criteria such as total quality, enable us to produce and offer to our clients a vast range of light fixtures for several applications.

Qualified Lighting design solutions identify EgoLuce as one of the most important player in the worldwide lighting producer. Products 100%Made in Italy.

40 YEARS OF SUCCESS

EgoLuce 40 years of experiences for your tailored lighting solutions.

Product evolution matches with new material, technologies and design, are actual achievements of Our collections.

Know-how and care in details in every production phases has been a forceful constant in these 40 years of successful activity. Problem solving liability, customer care and attention to each and every markets demand are a permanent mission for us. All of us... This steady Blend!

HUMAN APPROACH

Modern lighting controls take account of the human biorhythm and impact positively on health and well-being.

An intelligent energy and colour management of human light creates new spaces in empty, as only an emotional waterfall can do in You.

A new sensorial experiences for your Soul.

Light artful to Move, to Fly, to Melt itself, to Hit inside, to Engage a simply unforgettable Light.

Light survives in the shadow because its Led glare is shaded by glamour solutions.





DESIGN

Il design della luce è intrinsecamente funzionalità ed estetica e un approccio progettuale creativo e adattativo.

SUL PERCORSO DELL'INNOVAZIONE

Una luce senza tempo in grado di comprendere i nuovi bisogni umani in un mondo dinamico in continua rapida evoluzione.

Egoluce propone una luce vissuta come esperienza di vita per lighting designers, architetti, progettisti come partner e interlocutori.

QUALITÀ IN PRIMO LUOGO

Soluzioni di illuminazione che grazie ad un alto livello di CRI, offerta di temperature colore, bianco dinamico e UGR, sono in grado di adattarsi a tutti i progetti di interni ed esterni. fornendo una luce come risposta ai tuoi nuovi progetti architettonici.

Una luce capace di disegnare nuove forme nel vuoto per ottenere una esperienza visiva e sensoriale rinnovata.

LA TUA LUCE

Una concezione orientata alla semplificazione del concetto di design nella vita quotidiana: una luce che sa adattarsi alle esigenze.

Il tempo vola così veloce che la vita si armonizza come la luce per condurre i tuoi sensi in un'unica sinfonia.

ECO/EGO

Il riscaldamento globale e l'urgente necessità di ridurre drasticamente il consumo di energia e le emissioni di CO₂ sono ormai problemi riconosciuti a livello mondiale. In questa nuova era di consapevolezza ognuno ha un ruolo da svolgere, non importa quanto piccolo o grande sia.

EGOLUCE è un'azienda attenta all'ambiente e ha completamente rivisto la sua collezione proponendo nei suoi cataloghi una gamma completa di prodotti a ridotto consumo energetico.

Le scelte eco-compatibili contribuiscono alla sostenibilità ambientale e sono un tema fondamentale per Egoluce.

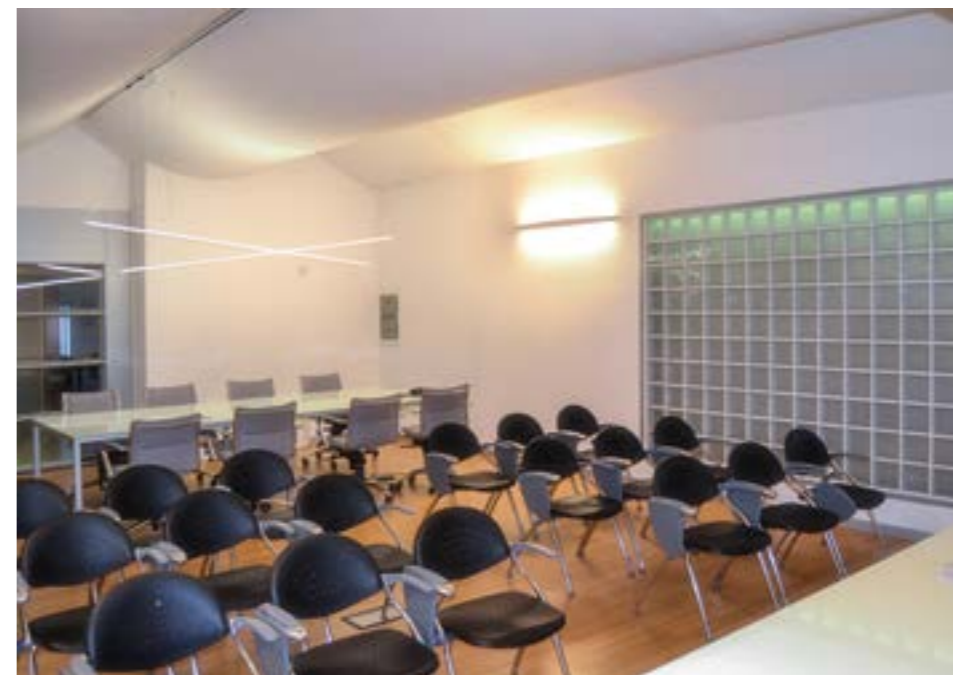

DESIGN

Lighting design is both inherently functional and innately aesthetic.

Design approach: generative and adaptive creativities

Conceptual design based on metaphors as a heuristic tool.

ON THE INNOVATION PATH

Timeless light able to figure out new human needs in a dynamic surfers world in constant evolution.

Egoluce proposes a light lived as a life experience to: Lighting specialist, Designers,

Architects, Specifiers as first partners.

QUALITY FIRST

Lighting solutions that because of: high CRI level, K° offer, dynamic white and UGR

solutions, are able to adjust themselves to every interiors and exteriors projects.

Egoluce a Light as response to Your new architectural projects, light draws spaces in several shapes to get your own sensorial experience.

YOUR OWN LIGHT

A new tradition oriented to the contemporary context that simplifies the new design

concept in our daily life: adjusting itself with Your needs.

The time flies by so fast that the life tunes itself with the light to bless your senses in a symphony.

ECO/EGO

Global warming and the urgent need to drastically cut energy consumption and CO₂

emission are now worldwide recognized problems. In this new era of awareness everyone has a role to play, no matter how small or big.

EGOLUCE is an environmentally conscious company and has totally revised his collection proposing in its catalogues a full range of low consumption products.

Eco friendly choices contribute to environment sustainability.



5 anni di garanzia. 5 years warranty.

I modelli **EGOLUCE** sono progettati e prodotti attenendosi ai migliori standard qualitativi esistenti sul mercato illuminotecnico seguendo il criterio del " fatto bene " nel pieno rispetto di regole sia qualitative che normative, nei campi di applicazione dei nostri prodotti.

- Cura e precisione della progettazione finalizzata a una produzione di altissima qualità.

- Eccellente qualità nella fabbricazione dei prodotti grazie a: selezione di componenti di alta gamma, cura nelle finiture, assemblaggio preciso e puntuale, imballaggio impeccabile per ogni tipo di spedizione.

- Collaudi severissimi con test di durata e affidabilità, sia sui singoli componenti come sugli apparecchi finiti. Il tutto assicura 5 anni di garanzia sui prodotti e componenti EGOLUCE correttamente installati come da fogli d'istruzione.

EGOLUCE models are designed and produced according to the best quality standards existing on the technical lighting market following the "well made" standard: in full compliance with both quality and regulatory rules, in the fields of application of our products.

Care and precision of the design aimed at a production of the highest quality.

Excellent quality in the manufacture of products thanks to: high selection of high-end components, attention to coating, precise and punctual assembly and packaging, perfect for all types of shipping.

Extremely severe durability and reliability tests: both on individual components and on final products.

These targets guarantees 5 years warranty on correctly installed EGOLUCE products and components following the instruction for users.

4 buone ragioni per scegliere **EGOLUCE**

4 good reasons to choose **EGOLUCE**

1 – LED

I prodotti EGOLUCE sono dotati di sorgenti Led di ultima generazione. Le diverse tecnologie applicate garantiscono ottime prestazioni:

Eccellente resa luminosa.
Ottimo valore di resa cromatica.
Svariate temperature di colore.
Sorgenti progettate per durare nel tempo.

2 – MATERIALI

Abbiamo selezionato i migliori materiali per apparecchi che devono durare nel tempo:

- ALLUMINIO: duttile ed inalterabile assicura un'ottima dispersione del calore (importante per ottimizzare la vita del LED).
- ACCIAIO INOX: la migliore garanzia per apparecchi che devono resistere ad agenti atmosferici o chimici (sale, cloro etc.).
- CLEAR CRYSTAL: per creare oggetti con effetti e proiezioni di luce unici.
- METACRILATO: per diffondere ed al tempo stesso mascherare la luce puntiforme del LED.

3 – CARATTERISTICHE GENERALI

Piccoli particolari che fanno grande un prodotto:

- Facile sostituzione del LED, la sorgente luminosa può essere rimpiazzata senza problemi come una comune lampadina.
- Presenza di adeguati dissipatori di calore su tutti i prodotti per garantire la durata dei LED.
- Possibilità, per la maggior parte dei prodotti, di essere alimentati sia a 350 mA che a 500 mA
- Ottimizzazione della resa luminosa tramite l'utilizzo di lenti o parabole.

4 – SICUREZZA

Una qualità garantita:

- Tutti i modelli vengono sottoposti a prove termiche e test funzionali.
- Tutti componenti elettronici proposti in catalogo (driver, dimmer) sono dotati di marchio europeo di qualità (ENEC).
- Il 100% della produzione viene sottoposto a test qualitativi e funzionali prima di essere immesso sul mercato.

1 – LED

EGOLUCE products are equipped with latest generation LED. We use different technologies to grant very good performances:

Excellent luminous efficacy.
Very good colour rendering.
Different light colours.
Designed to last for a very long time.

2 – MATERIALS

We have selected best materials for products that must have long-lasting life:

- ALUMINIUM – ductile and unalterable grants an optimal heat dissipation (important to grant longest operational life of LED).
- STAINLESS STEEL – the best warranty for fixtures that must resist to atmospheric or chemical agents (salt, chlorine, etc.)
- CLEAR CRYSTAL: to create objects with unique light effects and reflections.
- METHACRYLATE: to diffuse and at the same time shade the punctual light of LED.

3- GENERAL FEATURES

Small details that makes a great product:

- LED unit easy to replace, the light source can be replaced as if it were a common lamp.
- Proper heat sink device placed in every product to grant maximum lifetime for the LED.
- Most of the products can be operated both at 350 mA or 500 mA.
- Optimization of the luminous flux obtained by the use of lenses and reflectors.

4 – SAFETY

A granted quality

- All our models undergo rigorous temperature and functional testing.
- All electronic components displayed in our catalogue (drivers, dimmers) are marked with European quality certification (ENEC).
- 100% of our products undergo quality and functional end line test prior to commercialization.

Nome Name	Disegno Tecnico Technical Drawing	Dati Tecnici Technical Data	Foto Picture	Codice Code	Ambientazione Still Life
Alimentatori Drivers					
Accessori Accessories					
Capitolo Chapter					

I caratteri in rosso sono utilizzati per il codice e le specifiche che concorrono alla definizione del prodotto da indicare negli ordini.

Red characters are used for code and specifications needed to identify the product code to be indicated in orders.

Prodotto Product	Finitura Finish	Colore luce Light color	Lumen Nominali Gross Lumen Package	Specifiche Specifications

















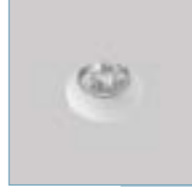

	Spot	pag. 14
	Architectural	pag. 74
	Newton	pag. 106
	Lighting systems	pag. 140
	Decorative lights	pag. 196
	Edison	pag. 226
	Outdoor	pag. 240
	Tecnology	pag. 278
	Accessory	pag. 304

SPOT

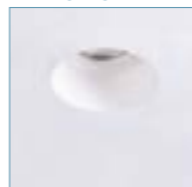

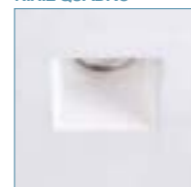
STAR  p. 18	STAR  p. 22	STAR MAXI  p. 26	STAR MAXI  p. 28	DISSY QUADRO  p. 32	DISSY TONDO  p. 33
EASY QUADRO  p. 36	EASY TONDO  p. 37	TAPPO MINI  p. 40	TAPPO  p. 42	TAPPO ORIENTABILE  p. 44	VERO QUADRO MINI  p. 48
VERO QUADRO  p. 48	VERO TONDO MINI  p. 49	VERO TONDO  p. 49	EDY MINI  p. 52	EDY  p. 54	DELTA MINI LED  p. 57
GEKO MINI  p. 60	GEKO  p. 61	GEKO QUADRO  p. 64	ZEN  p. 66	MODUS  p. 67	OKKIO  p. 634
TUBO MINI  p. 69	SNORKY INCASSO  p. 69	CORNO MINI  p. 70	CORNO  p. 70	EOS PIU'  p. 71	GAMMA  p. 71
STELLA  p. 71	SPECCHIO  p. 72				

ARCHITECTURAL



















STAR ZERO  p. 76	QUADRATO  p. 78	CASPER  p. 80	GHOST MINI LED  p. 82	GHOST LED  p. 83	GHOST MAXI LED  p. 84
ROTONDO  p. 86	ZERO  p. 88	MIRAGE MINI LED  p. 90	MIRAGE LED  p. 91	MIRAGE MAXI LED  p. 92	NIHIL TONDO MINI  p. 94
NIHIL TONDO  p. 95	NIHIL QUADRO MINI  p. 96	NIHIL QUADRO  p. 97	PHANTOM SYSTEM  p. 98		

NEWTON

NEWTON TRACK 48V  p. 110	NEWTON SLIM TRACK 48V  p. 112	NEWTON FLAT TRACK 48V  p. 114	NEWTON TRACK 230V  p. 120	NEWTON SLIM TRACK 230V  p. 122	NEWTON FLAT TRACK 230V  p. 124
NEWTON PLUS TRACK 230V  p. 126	NEWTON EASY TRACK 230V - GU10  p. 127	NEWTON SPOT  p. 130	NEWTON EASY 230V - GU10  p. 131	NEWTON SLIM SPOT  p. 132	NEWTON FLAT SPOT  p. 133
NEWTON SPOT RECESSED  p. 134	NEWTON SPOT EASY GU10  p. 135	NEWTON RAIL  p. 136	NEWTON SLIM RAIL  p. 138	NEWTON FLAT RAIL  p. 139	



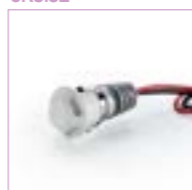



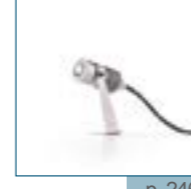
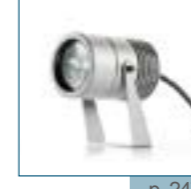

RAIL SYSTEM CEILING / WALL  p. 144	RAIL SYSTEM SUSPENSION  p. 150	RAIL SYSTEM WALL  p. 154	RAIL SYSTEM RECESSED  p. 160	LINEA  p. 166	LINEA MAXI  p. 170
LANCIA CAVO  p. 176	LANCIA TONDA CAVO  p. 178	EXTRA  p. 182	MARGO  p. 184	PLANA  p. 186	MAGIKA  p. 188
INTO  p. 190	WOODY  p. 192	ASTRA 15W  p. 194	ASTRA 9,6W  p. 194	ASTRA 4,8W  p. 194	

DECORATIVE LIGHTS

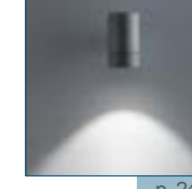
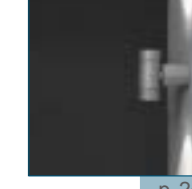
SNORKY  p. 198	SNORKY MAXY  p. 199	DOT TONDO DOT QUADRO  p. 200	DOT PLUS TONDO DOT PLUS QUADRO  p. 201	TRIM TONDO - QUADRO MONOEMISSIONE  p. 202	TRIM TONDO - QUADRO BIEMISSIONE  p. 202
FIRE FIRE RGB  p. 204	SPOON TONDO SPOON QUADRO  p. 206	LUCCIOLA LUCCIOLA RGB  p. 208	ICE TONDO - QUADRO ICE QUADRO RGB  p. 210	BITE TONDO BITE QUADRO  p. 212	SIRIO  p. 214
VEGA  p. 216	VEGA MAXI RGB  p. 217	ALCOR  p. 218	ALCOR MAXI RGB  p. 219	TOP  p. 220	TOP MINI  p. 220
PIX TONDO PIX QUADRO  p. 222	PIX TONDO RGB  p. 223	CERCHIETTO  p. 224	CRUISE  p. 224	SLOT  p. 225	

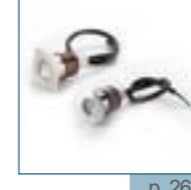
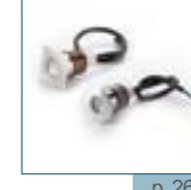
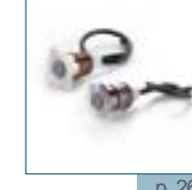
EDISON SYSTEM CEILING  p. 230	EDISON SYSTEM SUSPENSION  p. 230	TAPPO EDISON SPOT  p. 234	GEKO EDISON SPOT  p. 234
---	--	---	--

OUTDOOR

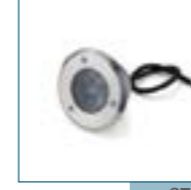
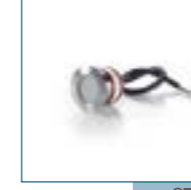
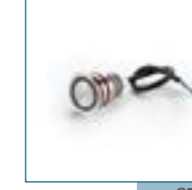
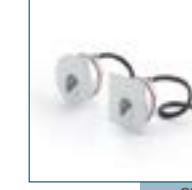
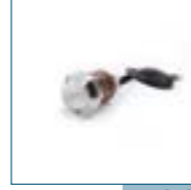
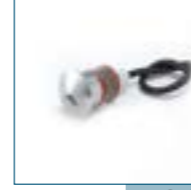
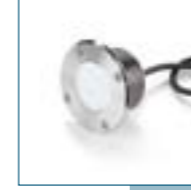
KEPI  p. 244	VISION 1  p. 246	VISION 3  p. 247	VISION 3 COB  p. 247	GEO MONOEMISSIONE  p. 248	GEO BIEMISSIONE  p. 248
SPOOK  p. 252	WANDA  p. 258	ZEPPELIN TONDO ZEPPELIN QUADRO  p. 262	ZEPPELIN TONDO RGB ZEPPELIN QUADRO RGB  p. 263	ZEPPELIN 25 PLUS  p. 264	ZEPPELIN MAXI COB  p. 264
ZEPPELIN MAXI  p. 266	ZEPPELIN ORIENTABILE  p. 268	TRIS  p. 270	SOFT  p. 271	CERCHIO CERCHIO RGB  p. 272	STEP TONDO STEP QUADRO  p. 274
KROSS  p. 278	VISTA  p. 276	DRIVE  p. 277			

	pag
STAR 1	18
STAR 2	18
STAR IP	20
STAR RBG	21
STAR 3	22
STAR 4	23
STAR MAXI TONDO	26
STAR MAXI QUADRO	28
DISSY QUADRO	32
DISSY TONDO	33
EASY QUADRO LED	36
EASY QUADRO 230V	36
EASY TONDO LED	37
EASY TONDO 230V	37
TAPPO MINI	40
TAPPO MINI 230V	40
TAPPO	42
TAPPO 230V	43
TAPPO ADJUSTABLE	44
TAPPO ADJUSTABLE 230V	45
VERO MINI QUADRO	48
VERO QUADRO	48
VERO MINI TONTO	49
VERO TONDO	49
EDY MINI	52
EDY 45° MINI	52
EDY LED	54
EDY 230V	55
DELTA MINI LED	57
GEKO MINI	60
GEKO MINI ADJUSTABLE 230V	60
GEKO 230V	61
GEKO ADJUSTABLE 230V	61
GEKO	62
GEKO ADJUSTABLE	63
GEKO QUADRO ADJUSTABLE	64
GEKO QUADRO ADJUSTABLE 230V	64
ZEN LED	66
ZEN	66
MODUS LED	67
MODUS	67
OCCHIO LED	68
TUBO MINI	69
SNORKY INCASSO	69
CORNO MINI 230V	70
CORNO 12V	70
CORNO 230V	70
EOS PIU'	71
GAMMA	71
STELLA	71
SPECCHIO INCASSO	72
SPECCHIO CORTO	72
SPECCHIO LUNGO	72





Spots à encastrer de petit diamètre soit minitrim soit sans cadre avec LED COB intégré.

Caracteristiques:

- Installation sur faux plafond par des ressorts ou des coffrages pour un effet disparition
- Installation sur béton ou maçonnerie par des coffrages dédiés
- Versions rondes ou carrées
- IP40, IP44 (Star 1 et 2), IP65 (Star IP) ou RGB
- Plusieurs faisceaux disponibles
- Source lumineuse reculée
- Plusieurs tonalités de lumière (2700K, 3000K, 4000K)
- Écrans satinés (st) ou transparents (tr)
- Finitions disponibles : blanc, noir, doré satiné, nickel satiné, chromé (seulement IP)
- Variateurs DALI, Push, 1-10V, et CASAMBI
- Unités d'urgence
- CRI>90 sur demande

Focos empotrados (Con o sin marco) de pequeño tamaño con LED COB integrado.

Características:

- Instalación empotrada en falso techo con muelles o con caja empotrada (marco redondo o cuadrado) con el foco empotrado al interior del spot "con efecto escondido"
- Instalación empotrada con caja por albañilería y por hormigón.
- Versión redonda y cuadrada.
- IP 40, IP 44 (Star 1 y 2), IP 65 (Star IP).
- Óptica disponible: 18°, 40°, 60°.
- Fuente de luz "con el foco empotrado"
- Vidrio satinado (st) o transparente (tr)
- Temperaturas de color: 2700, 3000 y 4000K.
- Acabados disponibles: blanco, negro, oro satinado, níquel mate y cromo (solo Star IP).
- Regulación Dimable: DALI, Push, 1-10V y CASAMBI.
- Grupo de emergencia.
- CRI> 90 a solicitud

Einbaustrahler (Minitrim oder ohne Blende) kleiner Abmessungen mit integrierter COB-LED.

Eigenschaften:

- Einbau an der Zwischendecke durch Federn oder mit Austauschbarer Einbaukästen (rund oder quadratisch)
- Einbau mit Einbaukästen für Wand und Beton.
- Runde und eckige Version.
- IP 40, IP 44 (Stern 1 und 2), IP 65 (Stern IP).
- Verfügbare Abstrahlwinkel: 18°, 40°, 60°.
- Rücklichtquelle.
- Satin (st) oder transparenter (tr) Bildschirm.
- Farbtemperaturen: 2700, 3000 und 4000K.
- Verfügbare Ausführungen: Weiß, Schwarz, Satin Gold, Nickel Matt und Chrom (nur Star IP).
- Dimmer: DALI, Push, 1-10V und CASAMBI.
- Notlicht Batterie.
- CRI> 90 auf Anfrage.

Встроенные споты, с тонкой рамкой или без, небольшого размера со встроенным светодиодом.

Характеристики:

- врезается в подвесной потолок с помощью пружин или с круглым или квадратным монтажным корпусом
- встраивается в кирпич или бетон с помощью монтажного корпуса
- круглый или квадратный варианты
- степень защиты IP 40, IP44 (Star1 и 2), IP 65 (Star IP)
- пучок света 18, 40, 60 градусов
- источник света углублен
- рассеиватель прозрачный (tr) или матовый (st)
- цветовая температура 2700, 3000, 4000K
- цвет: белый, черный, сатирированное золото, матовый никель и хром (только Star IP)
- диммирование: DALI, кнопка push, 1-10в и Casa Ambi
- аварийное питание можно подключить
- CRI>90 по запросу

Spots **STAR**

design: U.T. EGOLUCE

Faretti da incasso di dimensioni ridotte con LED COB integrato.

Caratteristiche:

- Installazione ad incasso su controsoffitto tramite molle o con casseforme (tonda o quadra) per effetto scomparsa.
- Installazione ad incasso con casseforme per muratura e per calcestruzzo.
- Versione Tonda e Quadrata.
- IP 40, (IP 44 Star 1 e 2 a richiesta), IP 65 (Star IP).
- Ottiche disponibili: 18°,40°,60°.
- Sorgente luminosa arretrata.
- Schermo satinato (st) o trasparente (tr).
- Temperature di colore: 2700, 3000 e 4000K.
- Finiture disponibili: Bianco, Nero, Oro Satinato, Nickel Matt e Cromo (solo Star IP).
- Dimmerazione: DALI, Push, 1-10V e CASAMBI.
- Gruppo d'emergenza.
- CRI>90 a richiesta.

Recessed spots of small dimensions with COB LED integrated.

Features:

- Recessed installation on the false ceiling through springs or with recessed boxes (round or square) with retrofit effect
- Recessed installation with recessed boxes for wall and for concrete.
- Round and square version.
- IP 40, (IP 44 Star 1 and 2 upon request), IP 65 (Star IP).
- Beam angles available: 18°,40°,60°.
- Backward lighting source.
- Satin (st) or transparent (tr) screen.
- Colours temperatures: 2700, 3000 and 4000K.
- Finitures available: White, Black, Satin gold, Nickel Matt and Chrome (just Star IP).
- Dimmer: DALI, Push, 1-10V and CASAMBI.
- Emergency group.
- CRI>90 upon request.

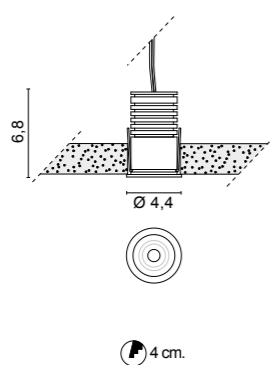

- 6690 Star 1**
- .01 Bianco - White
 - .02 Nero - Black
 - .25 Dorato satinato - Golded satin
 - .32 Nickel satinato - Nickel matt

Color temperature	Optics	Light sources	lm
/W 4000K	/18 /40 /60	LED 6,1W 17,3V 350mA	975lm
/W 4000K	/ST Satinato - Satin	LED 6,1W 17,3V 350mA	975lm
/WW 3000K	/18 /40 /60	LED 6,1W 17,3V 350mA	939lm
/WW 3000K	/ST Satinato - Satin	LED 6,1W 17,3V 350mA	939lm
/XW 2700K	/18 /40 /60	LED 6,1W 17,3V 350mA	896lm
/XW 2700K	/ST Satinato - Satin	LED 6,1W 17,3V 350mA	896lm



0,14 Kg

IP44 a richiesta. - IP44 upon request.



.01 Bianco - White



.02 Nero - Black



.25 Dorato satinato
Golded satin



.32 Nickel satinato
Nickel matt



.01/ST Satinato - Satin

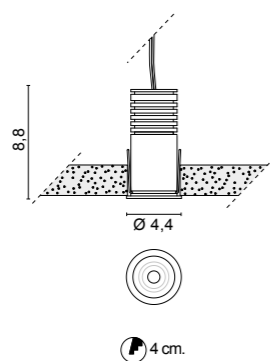

- 6691 Star 2**
- .01 Bianco - White
 - .02 Nero - Black
 - .25 Dorato satinato - Golded satin
 - .32 Nickel satinato - Nickel matt

Color temperature	Optics	Light sources	lm
/W 4000K	/18 /40 /60	LED 6,1W 17,3V 350mA	975lm
/W 4000K	/ST Satinato - Satin	LED 6,1W 17,3V 350mA	975lm
/WW 3000K	/18 /40 /60	LED 6,1W 17,3V 350mA	939lm
/WW 3000K	/ST Satinato - Satin	LED 6,1W 17,3V 350mA	939lm
/XW 2700K	/18 /40 /60	LED 6,1W 17,3V 350mA	896lm
/XW 2700K	/ST Satinato - Satin	LED 6,1W 17,3V 350mA	896lm



0,16 Kg

IP44 a richiesta. - IP44 upon request.



.01 Bianco - White



.02 Nero - Black



.25 Dorato satinato
Golded satin



.32 Nickel satinato
Nickel matt



.01/ST Satinato - Satin

Accessori (schemi installazioni pag. 24/25) - Accessories (installation pg. 24/25)



0206
Cassaforma tonda per installazione in cartongesso a scomparsa
Round wall box for installation in plasterboard false ceiling

- .01 Bianco - White
- .02 Nero - Black



0207
Cassaforma quadrata per installazione in cartongesso a scomparsa
Square wall box for installation in plasterboard false ceiling

- .01 Bianco - White
- .02 Nero - Black



0223
Cassaforma per calcestruzzo
Wall box for concrete

9,1 x 9,5 x 9h cm.



0224/C
Piastra per muratura
Plaster kit

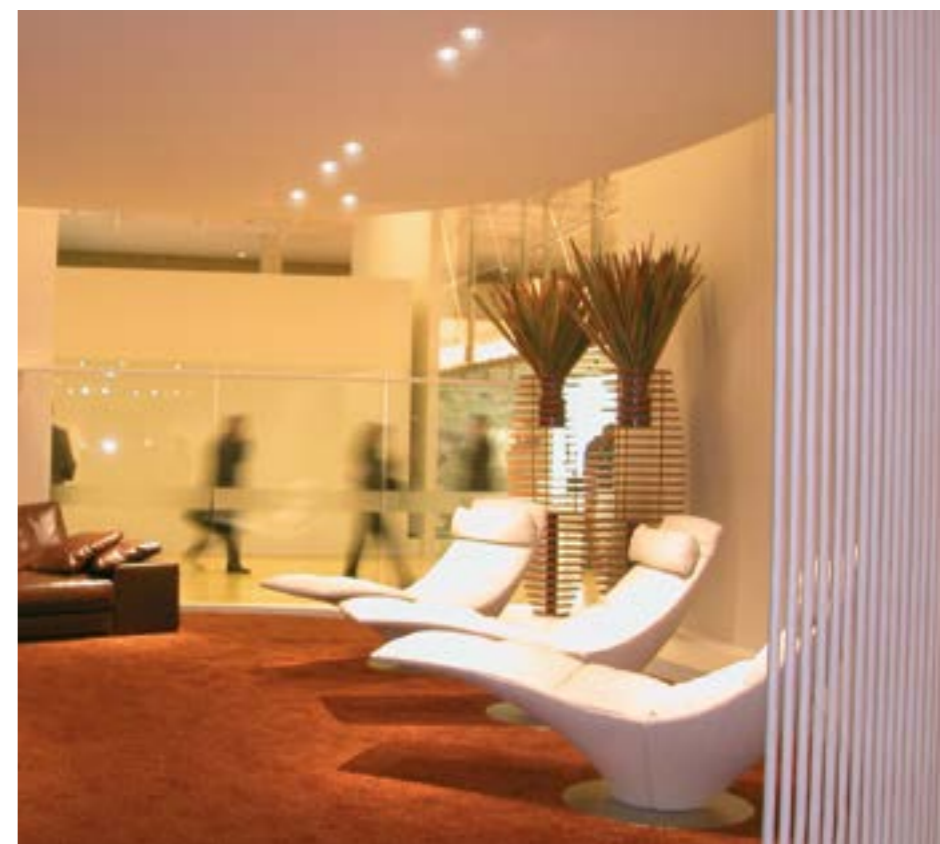

Cod.	* Drivers ON/OFF			DIMMABLE drivers				DIMMABLE drivers wireless Casambi		LED emergency unit
	0136/15	0125	0128	0141/DIM	0141/DALI	0145	0145/DALI	0718/CASA	0145/CASA	0115/EM Inverter + Battery + LED indicator
6690	1-2	1	1-2	PUSH - 1...10V	DIM DALI	DIM	DIM DALI	1-2	1-3	1
6691	1-2	1	1-2	1-2	1-2	1-3	1-3	1-2	1-3	1

Solo collegamento in serie - Only serial connection

*

I drivers 0136/15, 0125 e 0128 possono passare dal foro incasso del faretto. Il driver 0136/15 può essere inserito anche con cassaforma montata.

Drivers 0136/15, 0125 and 0128, can pass through the recessed hole of the spotlight. The driver 0136/15 can also be inserted with a mounted formwork.

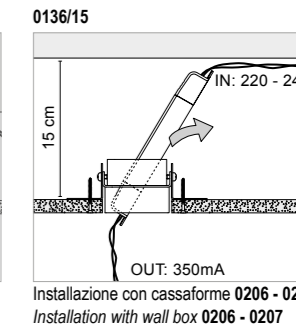
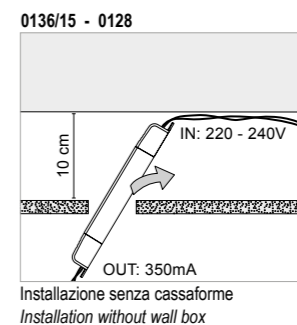
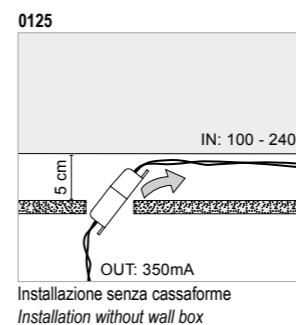

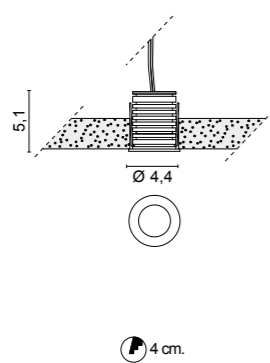

6692 Star IP

.01	Bianco - White
.02	Nero - Black
.31	Cromato - Chromed
Color temperature	
/W	4000K
/WW	3000K
/XW	2700K
Light sources	
	LED 2,5W 16,5V 150mA
	LED 2,5W 16,5V 150mA
	LED 2,5W 16,5V 150mA
Im	432lm
	416lm
	399lm
F	IP65
	0,12 Kg



.01 Bianco - White



.02 Nero - Black



.31 Cromato - Chromed



Accessori (schemi installazioni pag. 24/25) - **Accessories** (installation pg. 24/25)



0206

Cassaforma tonda per installazione in cartongesso a scomparsa
Round wall box for installation in plasterboard false ceiling

.01	Bianco - White
.02	Nero - Black



0207

Cassaforma quadrata per installazione in cartongesso a scomparsa
Square wall box for installation in plasterboard false ceiling

.01	Bianco - White
.02	Nero - Black



0223

Cassaforma per calcestruzzo
Wall box for concrete

9,1 x 9,5 x 9h cm.



0224/C

Piastra per muratura
Plaster kit

Drivers ON/OFF

Cod.	0151/150	3,7 cm.
	150mA	
6692	1-2	

Solo collegamento in serie - Only serial connection

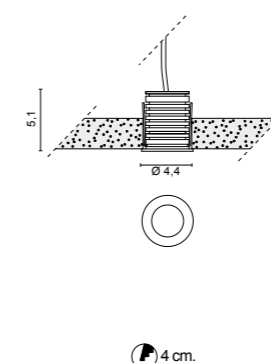

6693 Star RGB

.01	Bianco - White
.02	Nero - Black
.31	Cromato - Chromed
Light sources	
	LED 3x250mA
F	IP65
	0,14 Kg

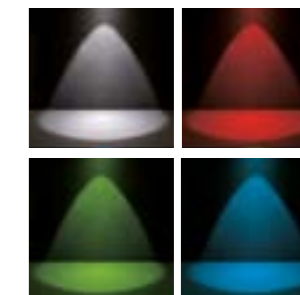

.01 Bianco - White



.02 Nero - Black



.31 Cromato - Chromed

Accessori (schemi installazioni pag. 24/25) - **Accessories** (installation pg. 24/25)



0206

Cassaforma tonda per installazione in cartongesso a scomparsa
Round wall box for installation in plasterboard false ceiling

.01	Bianco - White
.02	Nero - Black



0207

Cassaforma quadrata per installazione in cartongesso a scomparsa
Square wall box for installation in plasterboard false ceiling

.01	Bianco - White
.02	Nero - Black



0223

Cassaforma per calcestruzzo
Wall box for concrete

9,1 x 9,5 x 9h cm.



0224/C

Piastra per muratura
Plaster kit

Drivers RGB

0164	0167
120W	22W
IN:230V - OUT: 3x24V	

Driver RGB Casambi

0164/CASA
120W
IN:230V - OUT: 3x24V

Converter RGB

0168
IN:24V - OUT: 3x250 mA 1-5 Zeppelin RGB

0163
IR Sensor

0165
IR Remote controller

0166
Sinc Cable

Solo collegamento in serie - Only serial connection

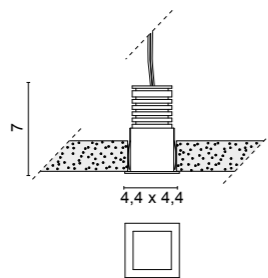

- 6695 Star 3**
- .01 Bianco - White
 - .02 Nero - Black
 - .25 Dorato satinato - Golded satin
 - .32 Nickel satinato - Nickel matt

Color temperature	Optics	Light sources	lm
/W 4000K	Satinato - Satin	LED 6,1W 17,3V 350mA	975lm
/WW 3000K	Satinato - Satin	LED 6,1W 17,3V 350mA	939lm
/XW 2700K	Satinato - Satin	LED 6,1W 17,3V 350mA	896lm

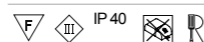

0,15 Kg

3,8 x 3,8 cm.



.01 Bianco - White

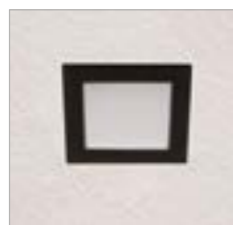

.02 Nero - Black



.25 Dorato satinato
Golded satin



.32 Nickel satinato
Nickel matt

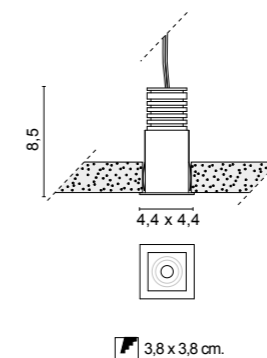

- 6696 Star 4**
- .01 Bianco - White
 - .02 Nero - Black
 - .25 Dorato satinato - Golded satin
 - .32 Nickel satinato - Nickel matt

Color temperature	Optics	Light sources	lm
/W 4000K	/18 /40 /60	LED 6,1W 17,3V 350mA	975lm
/W 4000K	/ST Satinato - Satin	LED 6,1W 17,3V 350mA	975lm
/WW 3000K	/18 /40 /60	LED 6,1W 17,3V 350mA	939lm
/WW 3000K	/ST Satinato - Satin	LED 6,1W 17,3V 350mA	939lm
/XW 2700K	/18 /40 /60	LED 6,1W 17,3V 350mA	896lm
/XW 2700K	/ST Satinato - Satin	LED 6,1W 17,3V 350mA	896lm

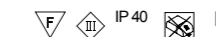

0,18 Kg



.01 Bianco - White



.02 Nero - Black



.25 Dorato satinato
Golded satin



.32 Nickel satinato
Nickel matt



.02/ST Satinato - Satin

Accessori (schemi installazioni pag. 24/25) - Accessories (installation pg. 24/25)



0223
Cassaforma per calcestruzzo
Wall box for concrete

9,1 x 9,5 x 9h cm.



0224/Q
Piastra per muratura
Plaster kit

Cod.	* Drivers ON/OFF			DIMMABLE drivers				DIMMABLE drivers wireless Casambi		LED emergency unit
	0136/15	0125	0128	0141/DIM	0141/DALI	0145	0145/DALI	0718/CASA	0145/CASA	0115/EM Inverter + Battery + LED indicator
6695	1-2	1	1-2	PUSH - 1...10V	DIM DALI	DIM	DIM DALI	1-2	1-3	1
6696	1-2	1	1-2	1-2	1-2	1-3	1-3	1-2	1-3	1

Solo collegamento in serie - Only serial connection

*

I drivers 0136/15, 0125 e 0128 possono passare dal foro incasso del faretto.

Drivers 0136/15, 0125 and 0128, can pass through the recessed hole of the spotlight.

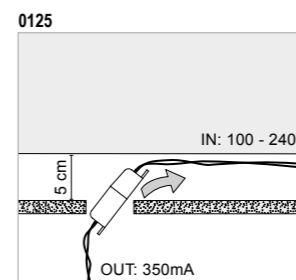

Installazione senza cassaforme
Installation without wall box

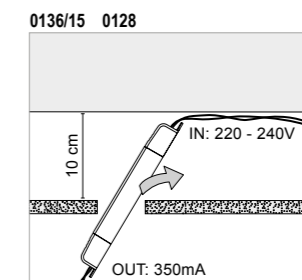

Installazione senza cassaforme
Installation without wall box

Accessori - Accessories



0206
Cassaforma tonda per installazione in cartongesso a scomparsa
Round wall box for installation in plasterboard false ceiling
.01 Bianco - White
.02 Nero - Black
6,7 cm.



0207
Cassaforma quadrata per installazione in cartongesso a scomparsa
Square wall box for installation in plasterboard false ceiling
.01 Bianco - White
.02 Nero - Black
5,5 x 5,5 cm.

Installazione su cartongesso: - Installation in plasterboard:

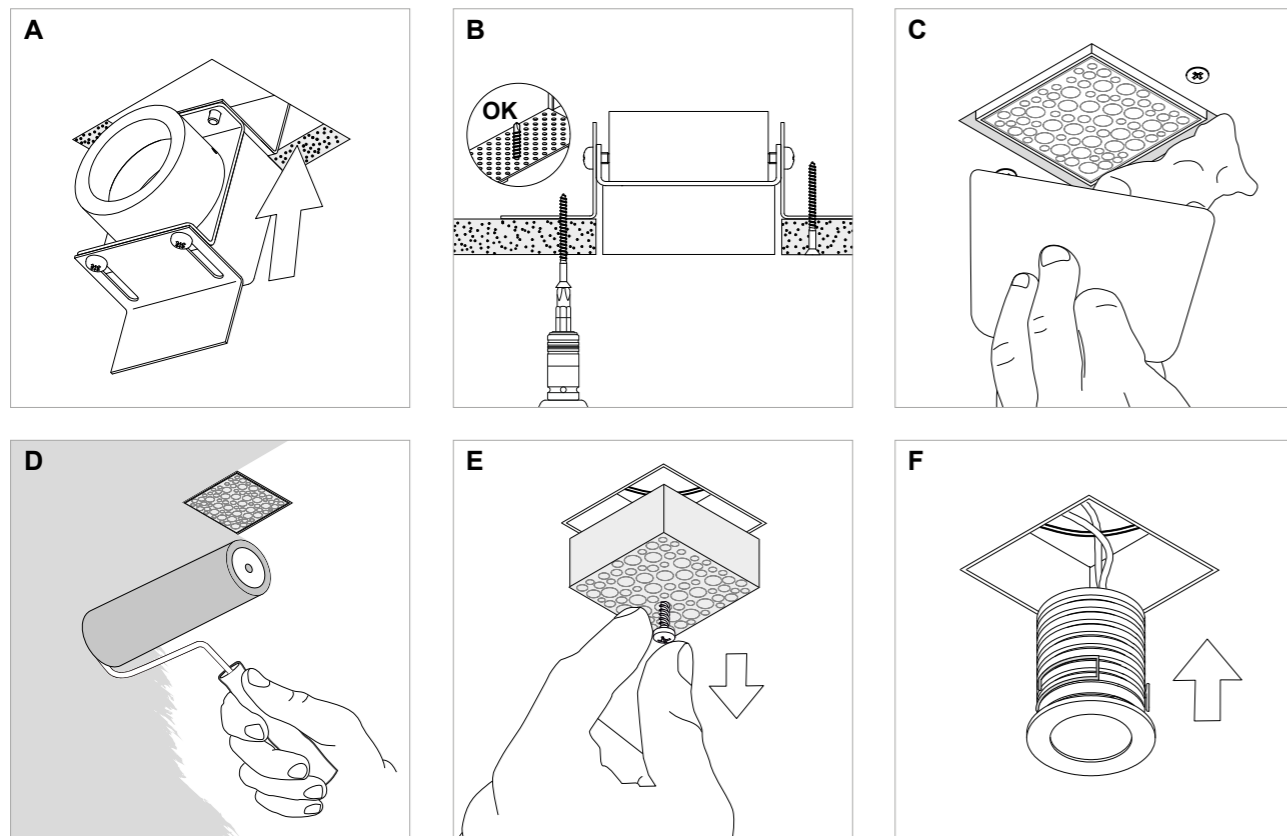

0206



0207



Accessori - Accessories



0223
Cassaforma per calcestruzzo
Wall box for concrete
9,1 x 9,5 x 9h cm.



0224/C
Piastra per muratura
Plaster kit
6690 Star 1
6691 Star 2
6692 Star IP
6693 Star RGB



0224/Q
Piastra per muratura
Plaster kit
6696 Star 3
6696 Star 4

Installazione su calcestruzzo: - Installation in concrete:

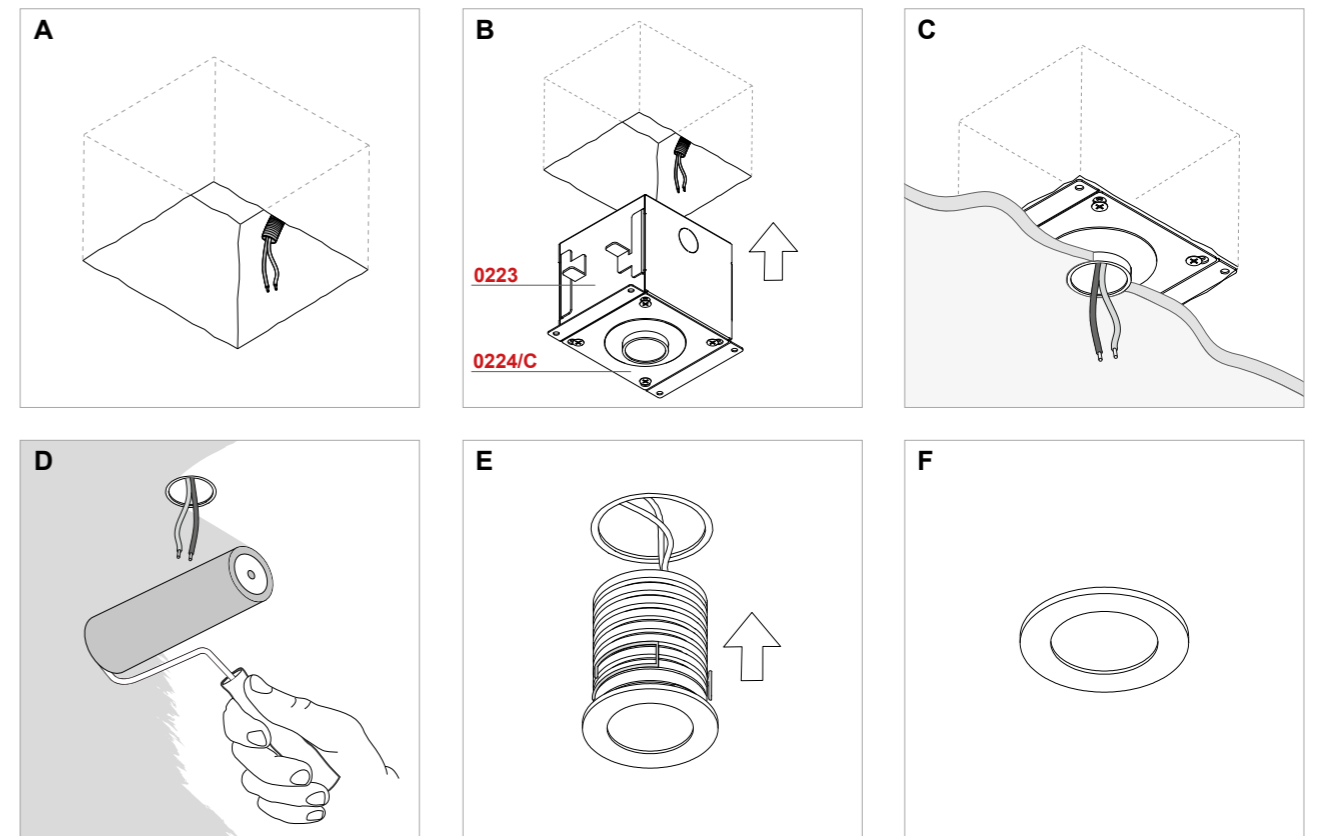

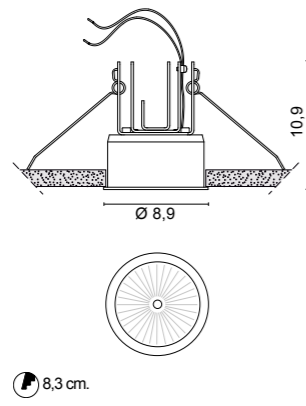

6705 Star Maxi tondo

- .01 Bianco - White
- .02 Nero - Black
- .25 Dorato satinato - Golded satin
- .32 Nickel satinato - Nickel matt

Color temperature	Optics	Light sources	lm
<i>NW</i> 4000K	<i>/12 /40</i>	LED 18,7W 37,4V 500mA	2444lm
<i>NW</i> 4000K	<i>/ST</i>	Satinato - Satin	2444lm
<i>NWW</i> 3000K	<i>/12 /40</i>	LED 18,7W 37,4V 500mA	2350lm
<i>NWW</i> 3000K	<i>/ST</i>	Satinato - Satin	2350lm
<i>XW</i> 2700K	<i>/12 /40</i>	LED 18,7W 37,4V 500mA	2255lm
<i>XW</i> 2700K	<i>/ST</i>	Satinato - Satin	2255lm

F III IP 40 R

0,40 Kg



.01 Bianco - White



.02 Nero - Black



.25 Dorato satinato
Golded satin



.32 Nickel satinato
Nickel matt



.02/ST Satinato - Satin

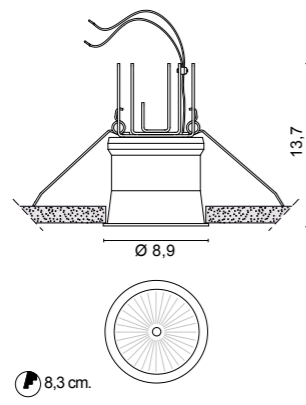

6706 Star Maxi tondo

- .01 Bianco - White
- .02 Nero - Black

Color temperature	Optics	Light sources	lm
<i>NW</i> 4000K	<i>/12 /40</i>	LED 18,7W 37,4V 500mA	2444lm
<i>NW</i> 4000K	<i>/ST</i>	Satinato - Satin	2444lm
<i>NWW</i> 3000K	<i>/12 /40</i>	LED 18,7W 37,4V 500mA	2350lm
<i>NWW</i> 3000K	<i>/ST</i>	Satinato - Satin	2350lm
<i>XW</i> 2700K	<i>/12 /40</i>	LED 18,7W 37,4V 500mA	2255lm
<i>XW</i> 2700K	<i>/ST</i>	Satinato - Satin	2255lm

F III IP 40 R

0,40 Kg



.01 Bianco - White



.02 Nero - Black



.01/ST Satinato - Satin



Cod.	Drivers ON/OFF
6705	0147/COB 500mA
6706	1

DIMMABLE drivers				
0141/DIM	0141/DALI	0145	0145/DALI	
PUSH - 1...10V	DIM DALI	DIM	DIM DALI	
1	1	1	1	
1	1	1	1	

DIMMABLE drivers wireless Casambi	
0718/CASA	0145/CASA
1	1
1	1

LED emergency unit	
0115/EM	Inverter + Battery + LED indicator
1	1
1	1

Solo collegamento in serie - Only serial connection

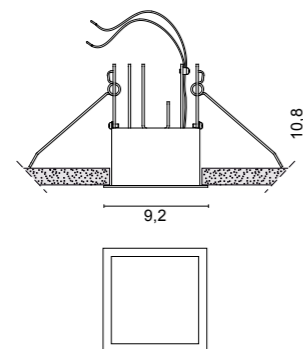

8,5 x 8,5cm.

6707 Star Maxi quadro

- .01 Bianco - White
- .02 Nero - Black
- .25 Dorato satinato - Golded satin
- .32 Nickel satinato - Nickel matt

Color temperature	Optics	Light sources	lm
/W 4000K	Satinato - Satin	LED 18,7W 37,4V 500mA	2444lm
/WW 3000K	Satinato - Satin	LED 18,7W 37,4V 500mA	2350lm
/XW 2700K	Satinato - Satin	LED 18,7W 37,4V 500mA	2255lm



0,40 Kg



.01 Bianco - White

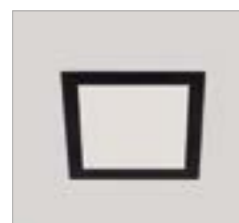

.02 Nero - Black

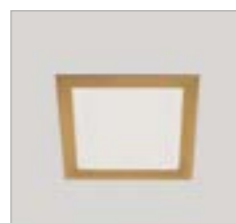

.25 Dorato satinato
Golded satin

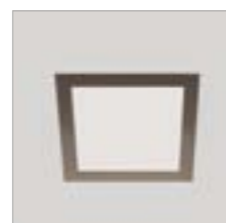

.32 Nickel satinato
Nickel matt

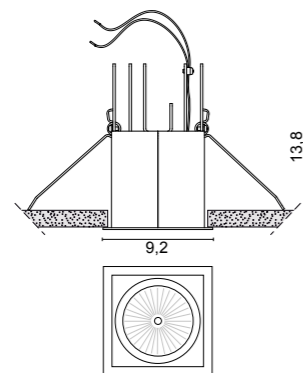

8,5 x 8,5cm.

6708 Star Maxi quadro

- .01 Bianco - White
- .02 Nero - Black

Color temperature	Optics	Light sources	lm
/W 4000K	/12 /40	LED 18,7W 37,4V 500mA	2444lm
/W 4000K	/ST Satinato - Satin	LED 18,7W 37,4V 500mA	2444lm
/WW 3000K	/12 /40	LED 18,7W 37,4V 500mA	2350lm
/WW 3000K	/ST Satinato - Satin	LED 18,7W 37,4V 500mA	2350lm
/XW 2700K	/12 /40	LED 18,7W 37,4V 500mA	2255lm
/XW 2700K	/ST Satinato - Satin	LED 18,7W 37,4V 500mA	2255lm



0,50 Kg



.01 Bianco - White

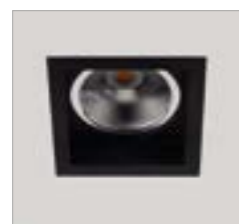

.02 Nero - Black

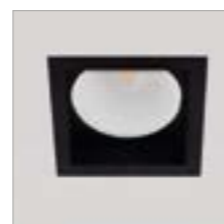

.02/ST Satinato - Satin



Cod.	Drivers ON/OFF	DIMMABLE drivers				DIMMABLE drivers wireless Casambi		LED emergency unit
	0147/COB 500mA	0141/DIM PUSH - 1...10V	0141/DALI DIM DALI	0145 DIM	0145/DALI DIM DALI	0718/CASA	0145/CASA	0115/EM Inverter + Battery + LED indicator
6707	1	1	1	1	1	1	1	1
6708	1	1	1	1	1	1	1	1

Solo collegamento in serie - Only serial connection



Spots à encastrer en aluminium avec LED COB intégré

Caracteristiques:

- Installation sur faux plafond par des ressorts
- IP44
- Versions rondes ou carrées
- Faisceaux disponible: 38°, sur demande 24° ou 58°
- Écrans satinés (st) ou transparents (tr)
- Tonalités de lumière 3000K, sur demande 2700K ou 4000K
- Finitions disponibles : blanc, noir, gris, nickel satiné, chromé, doré
- Variateurs DALI, Push, 1-10V, et CASAMBI
- Unités d'urgence
- CRI>90 sur demande

Focos empotrados (marco fino) con LED COB integrados.

Características:

- Instalación empotrada en falso techo con resortes "muelles"
- IP 44.
- Versión redonda y cuadrada.
- Óptica disponible 38°, A solicitud 24° y 58°.
- Vidrio satinado (st) o transparente (tr).
- Temperatura de color disponible 3000K. A solicitud 2700 y 4000K.
- Acabados disponibles: blanco, negro, gris, níquel mate, cromo y dorado.
- Regulación Dimable: DALI, Push, 1-10V y CASAMBI.
- Grupo de emergencia.
- CRI> 90 A solicitud

Einbaustrahler (Minitrim) mit COB-LED integriert.

Eigenschaften:

- Einbau an der Zwischendecke durch Federn
- IP 44.
- Runde und eckige Version.
- Abstrahlwinkel 38°. Auf Anfrage 24° und 58°.
- Satin (st) oder transparenter (tr) Bildschirm.
- Farbtemperatur verfügbar 3000K. Auf Anfrage 2700 und 4000K.
- Verfügbare Ausführungen: Weiß, Schwarz, Nickel Matt, Chrom und Gold.
- Dimmer: DALI, Push, 1-10V und CASAMBI.
- Notlicht Batterie.
- CRI> 90 auf Anfrage für die LED-COB-Version.

Встроенные споты с тонкой рамкой, светодиод на плате встроены.

Характеристики:

- врезается в подвесной потолок с помощью пружин
- IP44
- Круглый или квадратный варианты
- Пучок света 38 градусов, по запросу 24 и 58 градусов
- Рассеиватель матовый (st) или прозрачный (tr)
- Цветовая температура 3000K. По запросу 2700 и 4000K
- Цвет: белый, черный, серый, матовый никель, хром и золото
- Диммирование: DALI, кнопка push, 1-10v и Casa Ambi
- CRI>90 по запросу для

Spots DISSY

design: U.T. EGOLUCE

Faretti da incasso (flangia sottile) con LED COB integrato.

Caratteristiche:

- Installazione ad incasso su controsoffitto tramite molle.
- IP 44.
- Versione Tonda e Quadrata.
- Ottiche 38°. A richiesta 24° e 58°.
- Schermo satinato (st) o trasparente (tr).
- Temperature di colore 3000K. A richiesta 2700 e 4000K.
- Finiture disponibili: Bianco, Nero, Grigio, Nickel Matt, Cromo e Oro.
- Dimmerazione: DALI, Push, 1-10V e CASAMBI.
- Gruppo d'emergenza .
- CRI>90 a richiesta.

Recessed spots (minitrims) with COB LED on board.

Features:

- Recessed installation on the false ceiling through springs
- IP 44.
- Round and square version.
- Beam angles 38°. Upon request 24° and 58°.
- Satin (st) or transparent (tr) screen.
- Colour temperature 3000K. Upon request 2700 and 4000K.
- Finitures available: White, Black, Nickel Matt, Chrome and Gold.
- Dimmer: DALI, Push, 1-10V and CASAMBI.
- Emergency group.
- CRI>90 upon request

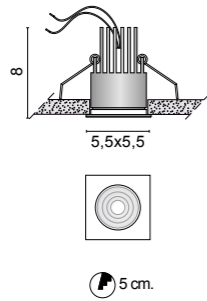

6409 Dissy quadro

- .01 Bianco - White
- .02 Nero - Black
- .03 Grigio - Grey
- .21 Dorato lucido - Shiny golded
- .31 Cromato - Chromed
- .32 Nickel satinato - Nickel mat

Color temperature	Optics	Light sources	lm
3000K /ST	Satinato - Satin	LED 8,9W 17,8V 500mA	1303lm
3000K /TR	Trasparente - Clear	LED 8,9W 17,8V 500mA	1303lm

IP 44 38° R 0,20 Kg



.01 Bianco - White



.02 Nero - Black



.03 Grigio - Grey



.21 Dorato lucido
Shiny golded



.31 Cromato
Chromed



.32 Nickel satinato
Nickel mat



/ST Satinato - Satin



/TR Trasparente - Clear

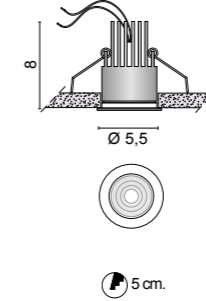

6410 Dissy tondo

- .01 Bianco - White
- .02 Nero - Black
- .03 Grigio - Grey
- .21 Dorato lucido - Shiny golded
- .31 Cromato - Chromed
- .32 Nickel satinato - Nickel mat

Color temperature	Optics	Light sources	lm
3000K /ST	Satinato - Satin	LED 8,9W 17,8V 500mA	1303lm
3000K /TR	Trasparente - Clear	LED 8,9W 17,8V 500mA	1303lm

IP 44 38° R 0,20 Kg



.01 Bianco - White



.02 Nero - Black



.03 Grigio - Grey



.21 Dorato lucido
Shiny golded



.31 Cromato
Chromed



.32 Nickel satinato
Nickel mat



/ST Satinato - Satin



/TR Trasparente - Clear

Cod.	Drivers ON/OFF			DIMMABLE drivers				DIMMABLE drivers wireless Casambi		LED emergency unit
	0125	0147/COB	0149/COB	0141/DIM	0141/DALI	0145	0145/DALI	0718/CASA	0145/CASA	0115/EM Inverter + Battery + LED indicator
6409	1	1-2	1	1-2	1-2	1-3	1-3	1-2	1-3	1

Solo collegamento in serie - Only serial connection

Cod.	Drivers ON/OFF			DIMMABLE drivers				DIMMABLE drivers wireless Casambi		LED emergency unit
	0125	0147/COB	0149/COB	0141/DIM	0141/DALI	0145	0145/DALI	0718/CASA	0145/CASA	0115/EM Inverter + Battery + LED indicator
6410	1	1-2	1	1-2	1-2	1-3	1-3	1-2	1-3	1

Solo collegamento in serie - Only serial connection



Spots à encastrer en aluminium avec source reculée

Caracteristiques:

- Installation sur faux plafond par des ressorts
- Sources: GU10, module COB LED, module Power LED
- Faisceaux disponibles: COB LED 24°, 40°, 60° Power LED : 10°, 25°, 40°
- Plusieurs tonalités de lumière (2700K, 3000K, 4000K et 5000K)
- Variateurs DALI, Push, 1-10V, et CASAMBI
- Unités d'urgence
- CRI>90 sur demande dans les versions COB LED

Focos empotrados (Marco fino) con fuentes de luz escondida

Características:

- Instalación empotrada en falso techo con muelles.
- Fuentes: GU10, COB Led Module y Power LED Module.
- IP 44 con el módulo LED COB 0108 / IP.
- Óptica disponible: COB Led 24°, 40° y 60° - Power Led 10°, 25° y 40°.
- Temperaturas de color: 2700, 3000, 4000 y 5000K.
- Regulación Dimable: DALI, Push, 1-10V y CASAMBI.
- Grupo de emergencia.
- CRI> 90 a solicitud en versione COB Led

Faretti da incasso (flangia sottile) con sorgenti arretrate.

Caratteristiche:

- Installazione ad incasso su controsoffitto tramite molle.
- Sorgenti: GU10, Modulo LED COB e Modulo Power LED.
- IP 44 utilizzando Modulo LED COB 0108/IP.
- Ottiche disponibili: LED COB 24°, 40° e 60° - Power LED 10°, 25° e 40°.
- Temperature di colore: 2700, 3000, 4000 e 5000K.
- Dimmerazione: DALI, Push, 1-10V e CASAMBI.
- Gruppo d'emergenza.
- CRI>90 a richiesta nelle versioni LED COB.

Встроенные споты с тонкой рамкой и углубленным источником света.

Характеристики:

- врезается в подвесной потолок с помощью пружин
- источники света: GU10, светодиодный модуль на плате или мощный светодиод
- степень защиты IP44 для светодиода на плате 0108/IP
- пучок света: на плате 24, 40 и 60 градусов; мощный светодиод 10, 25 и 40 градусов
- цветовая температура 2700, 3000, 4000 и 5000K
- цвета: белый, серый, матовое золото, хром и матовый никель
- диммирование: DALI, кнопка push, 1-10в и Casa Ambi
- аварийное питание может быть подключено
- по запросу CRI>90 для варианта светодиод на плате



Spots **EASY**

design: U.T. EGOLUCE

Faretti da incasso (flangia sottile) con sorgenti arretrate.

Caratteristiche:

- Installazione ad incasso su controsoffitto tramite molle.
- Sorgenti: GU10, Modulo LED COB e Modulo Power LED.
- IP 44 utilizzando Modulo LED COB 0108/IP.
- Ottiche disponibili: LED COB 24°, 40° e 60° - Power LED 10°, 25° e 40°.
- Temperature di colore: 2700, 3000, 4000 e 5000K.
- Dimmerazione: DALI, Push, 1-10V e CASAMBI.
- Gruppo d'emergenza.
- CRI>90 a richiesta nelle versioni LED COB.

Recessed spots (minitrin) with remote sources.

Features:

- Recessed installation on the false ceiling through springs.
- Sources: GU10, Module LED COB and Module Power LED.
- IP 44 using the module LED COB 0108/IP.
- Beam angles available: LED COB 24°, 40° and 60° Power LED 10°, 25° and 40°.
- Colour temperatures: 2700, 3000, 4000 and 5000K.
- Dimmer: DALI, Push, 1-10V and CASAMBI.
- Emergency group
- CRI>90 upon request for the LED Cob version.

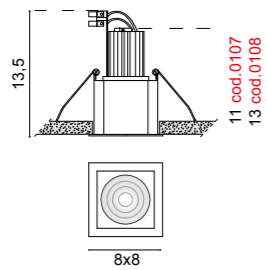

7x7 cm.

6431 Easy quadro LED

.01 Bianco - White



6431 + COB LED

Color temperature	Optics	Light sources	lm
0107/CW 5000K	/24 /40 /60	COB LED 6,1W 17,3V 350mA	1066lm
0107/W 4000K	/24 /40 /60	COB LED 6,1W 17,3V 350mA	975lm
0107/WW 3000K	/24 /40 /60	COB LED 6,1W 17,3V 350mA	939lm
0107/XW 2700K	/24 /40 /60	COB LED 6,1W 17,3V 350mA	896lm
0108/CW 5000K	/24 /40 /60	COB LED 8,9W 17,8V 500mA	1480lm
0108/W 4000K	/24 /40 /60	COB LED 8,9W 17,8V 500mA	1353lm
0108/WW 3000K	/24 /40 /60	COB LED 8,9W 17,8V 500mA	1303lm
0108/XW 2700K	/24 /40 /60	COB LED 8,9W 17,8V 500mA	1244lm

0108/W/IP 4000K	/24 /38 /58	COB LED IP44 8,9W 17,8V 500mA	1353lm
0108/WW/IP 3000K	/24 /38 /58	COB LED IP44 8,9W 17,8V 500mA	1303lm

6431 + POWER LED

Color temperature	Optics	Light sources	lm
0121 4000K	25°	POWER LED max 3x3W 700mA	846lm
0123 3000K	25°	POWER LED max 3x3W 700mA	804lm

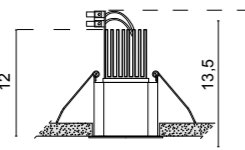

6,2x6,2

7x7 cm.



Cod. LED	Drivers ON/OFF				DIMMABLE drivers				DIMMABLE drivers wireless Casambi		LED emergency unit
	0125 350mA	0147/COB 500mA	0149/COB 500mA	0126 700mA	0141/DIM PUSH - 1...10V	0141/DALI DIM DALI	0145/DALI DIM DALI	0145 DIM	0718/CASA	0145/CASA	0115/EM Inverter + Battery + LED indicator
0107 - COB LED	1	NO	NO	NO	1-2	1-2	1-3	1-3	1-2	1-3	1
0108 - COB LED	1	1-2	1	NO	1-2	1-2	1-3	1-3	1-2	1-3	1
0121 - POWER LED	1-2	1-4	NO	1-2	1-2	1-2	1-6	1-6	2-4	1-6	1
0123 - POWER LED	1-2	1-4	NO	1-2	1-2	1-2	1-6	1-6	2-4	1-6	1

Solo collegamento in serie - Only serial connection

Accessori - Accessories



0288

Schermo in metacrilato satinato
solo per moduli e lampadine GU10 LED
Satin methacrylate screen
only for GU10 LED sources

.01 Bianco - White

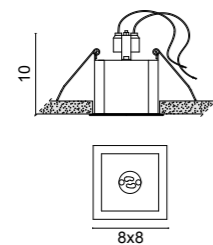

7 x 7 cm.

6432 Easy quadro 230V

.01 Bianco - White

Light sources
7W GU10 LED DIM (cod. 0104/16)
7W GU10 LED (cod. 0094/16)
max 50W GU10 (cod. 0072)



8x8

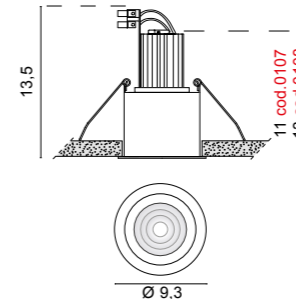

Ø 9,3

8,6 cm.

6441 Easy tondo LED

.01 Bianco - White



6441 + COB LED

Color temperature	Optics	Light sources	lm
0107/CW 5000K	/24 /40 /60	COB LED 6,1W 17,3V 350mA	1066lm
0107/W 4000K	/24 /40 /60	COB LED 6,1W 17,3V 350mA	975lm
0107/WW 3000K	/24 /40 /60	COB LED 6,1W 17,3V 350mA	939lm
0107/XW 2700K	/24 /40 /60	COB LED 6,1W 17,3V 350mA	896lm
0108/CW 5000K	/24 /40 /60	COB LED 8,9W 17,8V 500mA	1480lm
0108/W 4000K	/24 /40 /60	COB LED 8,9W 17,8V 500mA	1353lm
0108/WW 3000K	/24 /40 /60	COB LED 8,9W 17,8V 500mA	1303lm
0108/XW 2700K	/24 /40 /60	COB LED 8,9W 17,8V 500mA	1244lm

0108/W/IP 4000K	/24 /38 /58	COB LED IP44 8,9W 17,8V 500mA	1353lm
0108/WW/IP 3000K	/24 /38 /58	COB LED IP44 8,9W 17,8V 500mA	1303lm

6441 + POWER LED

Color temperature	Optics	Light sources	lm
0121 4000K	25°	POWER LED max 3x3W 700mA	846lm
0123 3000K	25°	POWER LED max 3x3W 700mA	804lm

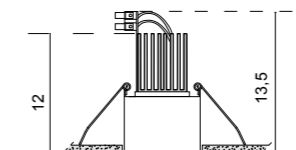

Ø 9,3

8,6 cm.



Cod. LED	Drivers ON/OFF				DIMMABLE drivers				DIMMABLE drivers wireless Casambi		LED emergency unit
	0125 350mA	0147/COB 500mA	0149/COB 500mA	0126 700mA	0141/DIM PUSH - 1...10V	0141/DALI DIM DALI	0145/DALI DIM DALI	0145 DIM	0718/CASA	0145/CASA	0115/EM Inverter + Battery + LED indicator
0107 - COB LED	1	NO	NO	NO	1-2	1-2	1-3	1-3	1-2	1-3	1
0108 - COB LED	1	1-2	1	NO	1-2	1-2	1-3	1-3	1-2	1-3	1
0121 - POWER LED	1-2	1-4	NO	1-2	1-2	1-2	1-6	1-6	2-4	1-6	1
0123 - POWER LED	1-2	1-4	NO	1-2	1-2	1-2	1-6	1-6	2-4	1-6	1

Solo collegamento in serie - Only serial connection

Accessori - Accessories



0289

Schermo in metacrilato satinato
solo per moduli e lampadine GU10 LED
Satin methacrylate screen
only for GU10 LED sources

.01 Bianco - White

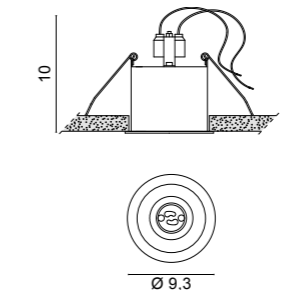

Ø 9,3

8,6 cm.

6442 Easy tondo 230V

.01 Bianco - White

Light sources
7W GU10 LED DIM (cod. 0104/16)
7W GU10 LED (cod. 0094/16)
max 50W GU10 (cod. 0072)

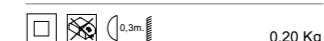

8x8



Spots à encastrer fixes ou réglables en alu injecté, avec source LED reculée, réalisés en trois tailles différents pour pouvoir utiliser toutes sources lumineuses

Caracteristiques:

- Installation sur faux plafond par des ressorts
- Installation sur maçonnerie par l'utilisation du Plaster Kit
- Fixes ou réglables
- Sources : GU5,3, GU10 Module COB LED, module Power LED
- IP 44 avec le module COB LED 0108/IP
- Faisceaux disponibles: COB LED 24°, 40°, 60° Power LED : 10°, 25°, 40°
- Plusieurs tonalités de lumière (2700K, 3000K, 4000K et 5000K)
- Variateurs DALI, Push, 1-10V, et CASAMBI
- Unités d'urgence
- CRI>90 sur demande dans les versions COB LED

Focos empotrados (Marco Fino) con LED puesto mas al interior del spot realizados en tres tamaños diferentes para permitir el uso de diversas fuentes de luz.

Características:

- Instalación empotrada en falso techo con muelles.
- Instalación empotrada con caja por albañilería y por hormigón.
- fijo o ajustable
- Fuentes: GU5,3 -GU10- Módulo LED COB y módulos LED de potencia.
- IP 44 con el módulo LED COB 0108 / IP.
- Óptica disponible: COB Led 24°, 40° y 60° - Power Led 10°, 25° y 40°.
- Temperaturas de color: 2700, 3000, 4000 y 5000K.
- Acabados disponibles: blanco, negro, oro satinado, oro, cobre, níquel mate y cromo.
- Regulación Dimable: DALI, Push, 1-10V y CASAMBI.
- Grupo de emergencia.
- CRI> 90 a solicitud en versiones COB Led.

Einbaustrahler (dünner Flansch) mit rückwärtiger LED in drei verschiedenen Abmessungen, um die Verwendung unterschiedlicher Licht Quellen zu ermöglichen.

Eigenschaften:

- Einbau an der Zwischendecke durch Federn
- Unterputzmontage in der Wand mit dem Plaster Kit
- Fest oder einstellbar
- Licht Quellen: GU5,3 - GU10 - Modul LED COB und Modul Power LED.
- IP 44 mit der Modul-LED COB 0108 / IP.
- Verfügbare Abstrahlwinkel: LED COB 24°, 40° und 60° - LED Power 10°, 25° und 40°.
- Farbtemperaturen: 2700, 3000, 4000 und 5000K.
- Verfügbare Ausführungen: Weiß, Schwarz, Satin Gold, Gold, Kupfer, Nickel Matt und Chrom.
- Dimmer: DALI, Push, 1-10V und CASAMBI.
- Notlicht Batterie.
- CRI> 90 auf Anfrage in der LED - COB-Version.

Встроенные споты (с узкой рамкой) с углубленным светодиодом в трех размерах и разными источниками света

Характеристики:

- монтаж в подвесной потолок с помощью пружин
- монтаж в кирпичную кладку с монтажным корпусом
- неподвижные или ориентируемые
- источники света GU5,3, GU10, светодиод на плате, мощный светодиод
- IP44 в модели со светодиодом на плате 0108/IP
- пучки света для светодиода на плате 24, 40, 60 градусов; для мощного светодиода 10, 25 и 40 градусов
- цветовая температура 2700, 3000, 4000 и 5000K
- цвета: белый, серый, матовое золото, медь, хром и матовый никель
- диммирование: DALI, кнопка push, 1-10v и Casa Ambi
- аварийное питание
- по запросу CRI>90 для варианта светодиод на плате

Spots **TAPPO** design: U.T. EGOLUCE

Faretti da incasso (flangia sottile) con LED arretrato, realizzati in tre dimensioni diverse per consentire l'utilizzo di varie sorgenti luminose.

Caratteristiche:

- Installazione ad incasso su controsoffitto tramite molle.
- Installazione ad incasso in murature utilizzando Plaster Kit.
- Fissi o orientabili
- Sorgenti: GU5,3 GU10 Modulo LED COB e Moduli Power LED.
- IP 44 utilizzando Modulo LED COB 0108/IP.
- Ottiche disponibili: LED COB 24°, 40° e 60° - Power LED 10°, 25° e 40°.
- Temperature di colore: 2700, 3000, 4000 e 5000K.
- Finiture disponibili: Bianco, Nero, Oro Satinato, Oro, Rame, Nickel Matt e Cromo.
- Dimmerazione: DALI, Push, 1-10V e CASAMBI.
- Gruppo d'emergenza .
- CRI>90 a richiesta nelle versioni LED COB.

Recessed spots (thin flange) with backward LED made in three different dimensions to allow the use of different lighting sources.

Features:

- Recessed installation on the false ceiling through springs
- Recessed installation in wall using the Plaster Kit
- Fixed or adjustable
- Sources: GU5,3 GU10 Modulo LED COB and Modules Power LED.
- IP 44 using the Module LED COB 0108/IP.
- Beam angles available: LED COB 24°, 40° and 60° Power LED 10°, 25° and 40°.
- Colours temperatures: 2700, 3000, 4000 and 5000K.
- Finitures available: White, Black, Satin gold, Gold, Copper, Nickel Matt and Chrome.
- Dimmer: DALI, Push, 1-10V and CASAMBI.
- Emergency group.
- CRI>90 upon request in the LED COB version.

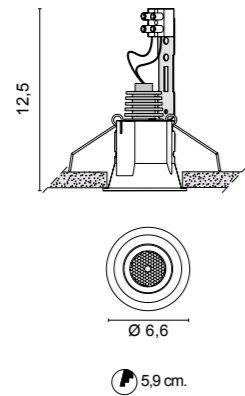

6327 Tappo mini

- .01 Bianco - White
- .02 Nero - Black

Light sources
12V 20W GU4
F III 0,10 Kg

6327 + POWER LED

Color temperature	Optics	Light sources	lm
0120 4000K	25°	POWER LED max 2W 500mA	209lm
0122 3000K	25°	POWER LED max 2W 500mA	199lm

Cod. LED	Drivers ON/OFF		DIMMABLE drivers				DIMMABLE drivers wireless Casambi	
	0127 500mA	0147/COB 500mA	0141/DIM PUSH - 1...10V	0141/DALI DIM DALI	0145/DALI DIM DALI	0145 DIM	0718/CASA 4-15	0145/CASA 1-21
0120 - POWER LED	1-6	1-12	1-11	1-11	1-21	1-21	4-15	1-21
0122 - POWER LED	1-6	1-12	1-11	1-11	1-21	1-21	4-15	1-21

Solo collegamento in serie - Only serial connection

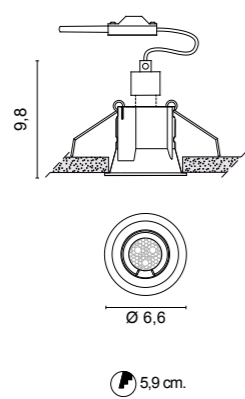

6325 Tappo mini

- .01 Bianco - White
- .02 Nero - Black

Light sources
3W GU10 LED (cod. 0093/19)
0,10 Kg

Accessori - Accessories



0221
Plaster kit traforato 12,5 x 9
Plaster kit perforated 12,5 x 9



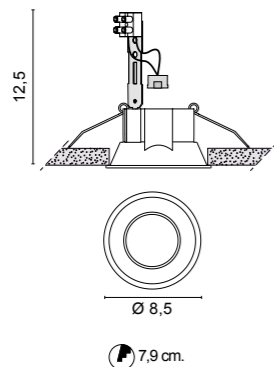

- 6330 Tappo**
- .01 Bianco - White
 - .02 Nero - Black
 - .21 Dorato lucido - Shiny golded
 - .25 Dorato satinato - Golded satin
 - .31 Cromato - Chromed
 - .32 Nickel satinato - Nickel mat
 - .38 Ramato lucido - Shiny copper

Light sources
12V 50W GU5.3

0,14 Kg

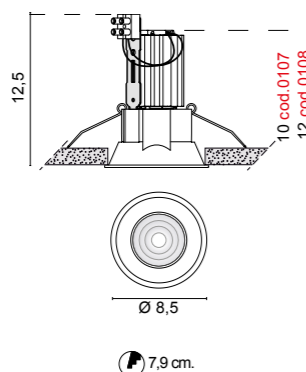

6330 + COB LED

Color temperature	Optics	Light sources	lm
0107/CW 5000K	/24 /40 /60	COB LED 6,1W 17,3V 350mA	1066lm
0107/NW 4000K	/24 /40 /60	COB LED 6,1W 17,3V 350mA	975lm
0107/WW 3000K	/24 /40 /60	COB LED 6,1W 17,3V 350mA	939lm
0107/XW 2700K	/24 /40 /60	COB LED 6,1W 17,3V 350mA	896lm

0108/CW 5000K	/24 /40 /60	COB LED 8,9W 17,8V 500mA	1480lm
0108/W 4000K	/24 /40 /60	COB LED 8,9W 17,8V 500mA	1353lm
0108/WW 3000K	/24 /40 /60	COB LED 8,9W 17,8V 500mA	1303lm
0108/XW 2700K	/24 /40 /60	COB LED 8,9W 17,8V 500mA	1244lm
0108/W/IP 4000K	/24 /38 /58	COB LED IP44 8,9W 17,8V 500mA	1353lm
0108/WW/IP 3000K	/24 /38 /58	COB LED IP44 8,9W 17,8V 500mA	1303lm

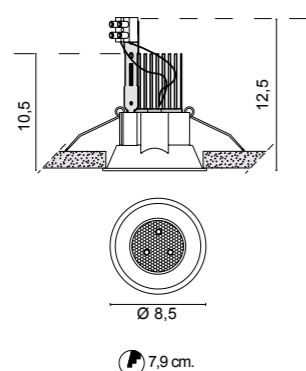

6330 + POWER LED

Color temperature	Optics	Light sources	lm
0121 4000K	25°	POWER LED max 3x3W 700mA	846lm
0123 3000K	25°	POWER LED max 3x3W 700mA	804lm

Accessori - Accessories



0203
Plaster kit traforato 15 x 19
Plaster kit perforated 15 x 19



0183
Dischi reggi lampadina in metacrilato
solo per il fissaggio del modulo LED.
Methacrylate disks
only for fixing LED module.



/TR Trasparente - Clear



/ST Satinato - Satin

Cod. LED	Drivers ON/OFF				DIMMABLE drivers				DIMMABLE drivers wireless Casambi		LED emergency unit
	0125 350mA	0147/COB 500mA	0149/COB 500mA	0126 700mA	0141/DIM PUSH - 1...10V	0141/DALI DIM DALI	0145/DALI DIM DALI	0145 DIM	0718/CASA	0145/CASA	0115/EM Inverter + Battery + LED indicator
0107 - COB LED	1	NO	NO	NO	1-2	1-2	1-3	1-3	1-2	1-3	1
0108 - COB LED	1	1-2	1	NO	1-2	1-2	1-3	1-3	1-2	1-3	1
0121 - POWER LED	1-2	1-4	NO	1-2	1-2	1-2	1-6	1-6	2-4	1-6	1
0123 - POWER LED	1-2	1-4	NO	1-2	1-2	1-2	1-6	1-6	2-4	1-6	1

Solo collegamento in serie - Only serial connection

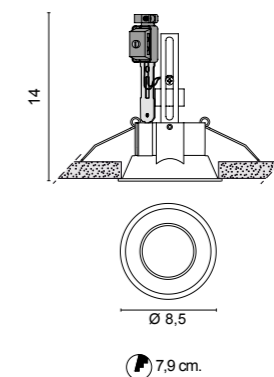

- 6329 Tappo 230V**
- .01 Bianco - White
 - .02 Nero - Black
 - .21 Dorato lucido - Shiny golded
 - .25 Dorato satinato - Golded satin
 - .31 Cromato - Chromed
 - .32 Nickel satinato - Nickel mat
 - .38 Ramato lucido - Shiny copper

Light sources
7W GU10 LED DIM (cod. 0104/16)
7W GU10 LED (cod. 0094/16)
max 50W GU10 (cod. 0072)

0,20 Kg



.01 Bianco - White



.02 Nero - Black



.21 Dorato lucido - Shiny golded



.25 Dorato satinato - Golded satin



.31 Cromato - Chromed



.32 Nickel satinato - Nickel mat



.38 Ramato lucido - Shiny copper



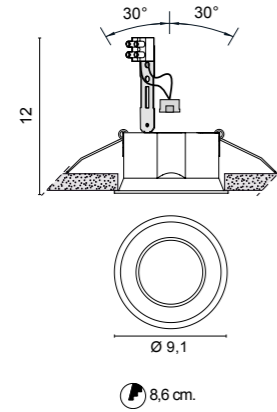

6318 Tappo Adjustable
 .01 Bianco - White
 .02 Nero - Black

Light sources
 12V 50W GU5.3

0,22 Kg

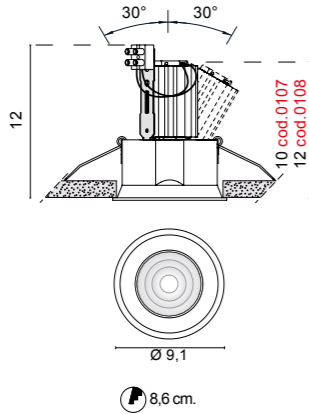

6318 + COB LED

Color temperature	Optics	Light sources	lm
0107/CW 5000K	/24 /40 /60	COB LED 6,1W 17,3V 350mA	1066lm
0107/W 4000K	/24 /40 /60	COB LED 6,1W 17,3V 350mA	975lm
0107/WW 3000K	/24 /40 /60	COB LED 6,1W 17,3V 350mA	939lm
0107/XW 2700K	/24 /40 /60	COB LED 6,1W 17,3V 350mA	896lm
0108/CW 5000K	/24 /40 /60	COB LED 8,9W 17,8V 500mA	1480lm
0108/W 4000K	/24 /40 /60	COB LED 8,9W 17,8V 500mA	1353lm
0108/WW 3000K	/24 /40 /60	COB LED 8,9W 17,8V 500mA	1303lm
0108/XW 2700K	/24 /40 /60	COB LED 8,9W 17,8V 500mA	1244lm
0108/W/IP 4000K	/24 /38 /58	COB LED IP44 8,9W 17,8V 500mA	1353lm
0108/WW/IP 3000K	/24 /38 /58	COB LED IP44 8,9W 17,8V 500mA	1303lm

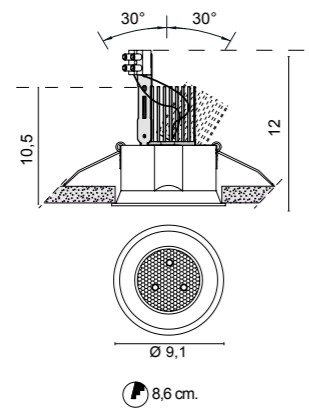

6318 + POWER LED

Color temperature	Optics	Light sources	lm
0121 4000K	25°	POWER LED max 3x3W 700mA	846lm
0123 3000K	25°	POWER LED max 3x3W 700mA	804lm

Accessori - Accessories



0183
 Dischi reggi lampadina in metacrilato solo per il fissaggio del modulo LED.
 Methacrylate disks only for fixing LED module.

/TR Trasparente - Clear /ST Satinato - Satin

Cod. LED	Drivers ON/OFF				DIMMABLE drivers				DIMMABLE drivers wireless Casambi		LED emergency unit
	0125 350mA	0147/COB 500mA	0149/COB 500mA	0126 700mA	0141/DIM PUSH - 1...10V	0141/DALI DIM DALI	0145/DALI DIM DALI	0145 DIM	0718/CASA	0145/CASA	0115/EM Inverter + Battery + LED indicator
0107 - COB LED	1	NO	NO	NO	1-2	1-2	1-3	1-3	1-2	1-3	1
0108 - COB LED	1	1-2	1	NO	1-2	1-2	1-3	1-3	1-2	1-3	1
0121 - POWER LED	1-2	1-4	NO	1-2	1-2	1-2	1-6	1-6	2-4	1-6	1
0123 - POWER LED	1-2	1-4	NO	1-2	1-2	1-2	1-6	1-6	2-4	1-6	1

Solo collegamento in serie - Only serial connection

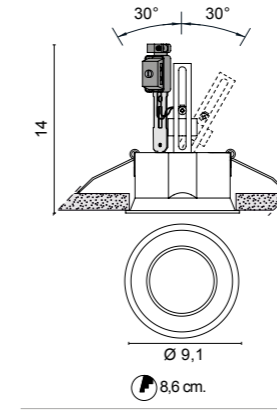

6319 Tappo Adjustable 230V
 .01 Bianco - White
 .02 Nero - Black

Light sources
 7W GU10 LED DIM (cod. 0104/16)
 7W GU10 LED (cod. 0094/16)
 max 50W GU10 (cod. 0072)

0,28 Kg





Spots à encastrer minitrim en alu injecté, avec source COB LED intégré, réalisés en deux tailles différents avec rendement lumineux élevé.

Caracteristiques:

- Installation sur faux plafond par des ressorts
- IP 40 et IP44 (sur demande)
- Écrans satinés (st) ou transparents (en série)
- Plusieurs tonalités de lumière (2700K, 3000K, 4000K)
- Variateurs DALI, Push, 1-10V, et CASAMBI
- Unités d'urgence

Focos empotrados (Marco Fino) con alta eficiencia luminosa y LED COB integrado.

Características:

- Instalación empotrada en falso techo con muelles.
- IP 40, IP 44 (A Solicitud).
- Vidrio satinado (st) o transparente (estándar).
- Temperaturas de color: 2700, 3000 y 4000K.
- Regulación Dimable: DALI, Push, 1-10V y CASAMBI.
- Grupo de emergencia.

Einbaustrahler (dünnere Flansch) mit hoher Lichtausbeute durch integrierte COB-LED

Eigenschaften:

- Einbau an der Zwischendecke durch Federn
- IP 40, IP 44 (auf Anfrage).
- Satin (st) oder transparent (Standardversion)
- Farbtemperaturen: 2700, 3000 und 4000K.
- Dimmer: DALI, Push, 1-10V und CASAMBI.
- Notlicht Batterie.

Встроенные высокоэффективные споты (с узкой рамкой) со светодиодом на плате

Характеристики:

- монтаж в подвесной потолок с помощью пружин
- IP40, IP44 по запросу
- рассеиватель матовый (st) или прозрачный (tr)
- цветовая температура 2700, 3000 и 4000K
- диммирование: DALI, кнопка push, 1-10в и Casa Ambi
- аварийный блок питания

Spots **VERO**

design: **U.T. EGOLUCE**

Faretti da incasso (flangia sottile) ad alta efficienza luminosa con LED COB integrato.

Caratteristiche:

- Installazione ad incasso su controsoffitto tramite molle.
- IP 40, IP 44 (a richiesta).
- Schermo satinato (st) o trasparente (di serie).
- Temperature di colore: 2700, 3000 e 4000K.
- Dimmerazione: DALI, Push, 1-10V e CASAMBI.
- Gruppo d'emergenza.

Recessed spots (thin flange) with high luminous efficiency with COB LED integrated

Features:

- Recessed installation on the false ceiling through springs
- IP 40, IP 44 (upon request).
- Satin (st) or transparent (standard version)
- Colours temperatures: 2700, 3000 and 4000K.
- Dimmer: DALI, Push, 1-10V and CASAMBI.
- Emergency group.

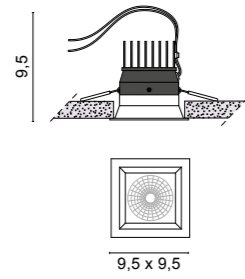

8,5 x 8,5 cm.

6426 Vero mini quadro

.01 Bianco - White

Color temperature	Options	Light sources	lm
<i>NW</i> 4000K	<i>/ST</i> Satinato - Satin	LED 12,5W 35,9V 350mA	1845lm
<i>NW</i> 4000K	<i>/P</i> IP44	LED 12,5W 35,9V 350mA	1845lm
<i>NW</i> 4000K	<i>/ST/P</i> Satinato - Satin + IP44	LED 12,5W 35,9V 350mA	1845lm
<i>MW</i> 3000K	<i>/ST</i> Satinato - Satin	LED 12,5W 35,9V 350mA	1774lm
<i>MW</i> 3000K	<i>/P</i> IP44	LED 12,5W 35,9V 350mA	1774lm
<i>MW</i> 3000K	<i>/ST/P</i> Satinato - Satin + IP44	LED 12,5W 35,9V 350mA	1774lm

F II III 50° R 0,35 Kg

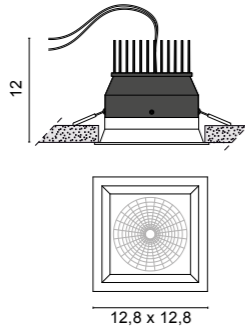

11,5 x 11,5 cm.

6427 Vero quadro

.01 Bianco - White

Color temperature	Options	Light sources	lm
<i>NW</i> 4000K	<i>/ST</i> Satinato - Satin	LED 17,5W 35V 500mA	2814lm
<i>NW</i> 4000K	<i>/P</i> IP44	LED 17,5W 35V 500mA	2814lm
<i>NW</i> 4000K	<i>/ST/P</i> Satinato - Satin + IP44	LED 17,5W 35V 500mA	2814lm
<i>MW</i> 3000K	<i>/ST</i> Satinato - Satin	LED 17,5W 35V 500mA	2707lm
<i>MW</i> 3000K	<i>/P</i> IP44	LED 17,5W 35V 500mA	2707lm
<i>MW</i> 3000K	<i>/ST/P</i> Satinato - Satin + IP44	LED 17,5W 35V 500mA	2707lm

F II III 50° R 0,70 Kg

/ST Con diffusore in metacrilato satinato - With satin methacrylate diffuser
/P Protezione IP44 della parte esposta - Exposed part protection IP44



Cod. LED	Drivers ON/OFF			DIMMABLE drivers				DIMMABLE drivers wireless Casambi		LED emergency unit	
	0128 350mA	0147/COB 500mA	0169 Multi Power Driver	0141/DIM PUSH -1...10V	0141/DALI DIM DALI	0145 DIM	0145/DALI DIM DALI	0718/CASA	0145/CASA	0115/EM	Inverter + Battery + LED indicator
6426	1	NO	1	1	1	1-2	1-2	1	1-2	1	1
6427	1	1	1	1	1	1-2	1-2	1	1-2	1	1

Solo collegamento in serie - Only serial connection

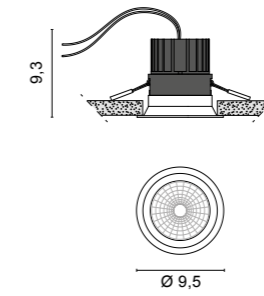

8,5 cm.

6433 Vero mini tondo

.01 Bianco - White

Color temperature	Options	Light sources	lm
<i>NW</i> 4000K	<i>/ST</i> Satinato - Satin	LED 12,5W 35,9V 350mA	1845lm
<i>NW</i> 4000K	<i>/P</i> IP44	LED 12,5W 35,9V 350mA	1845lm
<i>NW</i> 4000K	<i>/ST/P</i> Satinato - Satin + IP44	LED 12,5W 35,9V 350mA	1845lm
<i>MW</i> 3000K	<i>/ST</i> Satinato - Satin	LED 12,5W 35,9V 350mA	1774lm
<i>MW</i> 3000K	<i>/P</i> IP44	LED 12,5W 35,9V 350mA	1774lm
<i>MW</i> 3000K	<i>/ST/P</i> Satinato - Satin + IP44	LED 12,5W 35,9V 350mA	1774lm

F II III 50° R 0,25 Kg

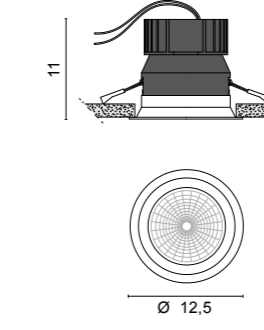

11,5 cm.

6434 Vero tondo

.01 Bianco - White

Color temperature	Options	Light sources	lm
<i>NW</i> 4000K	<i>/ST</i> Satinato - Satin	LED 17,5W 35V 500mA	2814lm
<i>NW</i> 4000K	<i>/P</i> IP44	LED 17,5W 35V 500mA	2814lm
<i>NW</i> 4000K	<i>/ST/P</i> Satinato - Satin + IP44	LED 17,5W 35V 500mA	2814lm
<i>MW</i> 3000K	<i>/ST</i> Satinato - Satin	LED 17,5W 35V 500mA	2707lm
<i>MW</i> 3000K	<i>/P</i> IP44	LED 17,5W 35V 500mA	2707lm
<i>MW</i> 3000K	<i>/ST/P</i> Satinato - Satin + IP44	LED 17,5W 35V 500mA	2707lm

F II III 50° R 0,50 Kg

/ST Con diffusore in metacrilato satinato - With satin methacrylate diffuser
/P Protezione IP44 della parte esposta - Exposed part protection IP44



Cod. LED	Drivers ON/OFF			DIMMABLE drivers				DIMMABLE drivers wireless Casambi		LED emergency unit	
	0128 350mA	0147/COB 500mA	0169 Multi Power Driver	0141/DIM PUSH -1...10V	0141/DALI DIM DALI	0145 DIM	0145/DALI DIM DALI	0718/CASA	0145/CASA	0115/EM	Inverter + Battery + LED indicator
6426	1	NO	1	1	1	1-2	1-2	1	1-2	1	1
6427	1	1	1	1	1	1-2	1-2	1	1-2	1	1

Solo collegamento in serie - Only serial connection



Spots à encastrer en alu, avec source LED reculée, réalisés en deux tailles différents pour pouvoir utiliser toutes sources lumineuses.

Caracteristiques:

- Installation sur faux plafond par des ressorts
- Installation sur maçonnerie par une coffrage.
- Sources: GU10 Module COB LED, module Power LED
- IP 44 avec le module COB LED 0108/IP
- Faisceaux disponibles: COB LED 24°, 40°, 60° Power LED : 10°, 25°, 40°
- Finitions disponibles: blanc, noir, nickel satiné, chromé, doré satiné
- Variateurs DALI, Push, 1-10V, et CASAMBI
- Unités d'urgence
- CRI>90 sur demande dans les versions COB LED

Focos empotrados con LED escondido en dos tamaños diferentes para permitir el uso de varias fuentes de luz.

Características:

- Instalación empotrada en falso techo con muelles.
- Instalación empotrada con caja por albañilería y por hormigón
- Fuentes: GU10, COB Led Module y Power LED Module.
- IP 44 con el módulo LED COB 0108 / IP.
- Ópticas disponible: COB Led 24°, 40° y 60° - Power Led 10°, 25° y 40°.
- Temperaturas de color: 2700, 3000, 4000 y 5000K.
- Acabados disponibles: blanco, gris, oro satinado, cromo y níquel mate.
- Regulación Dimable: DALI, Push, 1-10V y CASAMBI.
- Grupo de emergencia.
- CRI> 90 a solicitud en versiones COB Led

Einbaustrahler mit nachrüstbarer LED in zwei verschiedenen Abmessungen ermöglichen den Einsatz unterschiedlicher Licht Quellen.

Eigenschaften:

- Einbau an der Zwischendecke durch Federn.
- Einbau mit Einbaukästen für die Wand.
- Licht Quellen: GU10, Module Led COB und Module Power Led.
- IP 44 mit der Modul-LED COB 0108 / IP.
- Verfügbare Abstrahlwinkel: LED COB 24°, 40° und 60° - LED Power 10°, 25° und 40°.
- Farbtemperaturen: 2700, 3000, 4000 und 5000K.
- Verfügbare Ausführungen: Weiß, Grau, Satin Gold, Chrom und Nickel Matt.
- Dimmer: DALI, Push, 1-10V und CASAMBI.
- Notlicht Batterie.
- CRI> 90 auf Anfrage in der LED-COB-Version.

Встроенные споты с углубленным светодиодом в двух размерах и с разными источниками света.

Характеристики:

- монтаж в подвесной потолок с помощью пружин
- монтаж в кирпичную кладку с монтажным корпусом
- источники света GU10, светодиод на плате, мощный светодиод
- IP44 в модели со светодиодом на плате 0108/IP
- пучки света для светодиода на плате 24, 40, 60 градусов; для мощного светодиода 10, 25 и 40 градусов
- цветовая температура 2700, 3000, 4000 и 5000K
- цвета: белый, серый, матовое золото, хром и матовый никель
- диммирование: DALI, кнопка push, 1-10в и Casa Ambi
- аварийное питание
- по запросу CRI>90 с вариантом светодиод на плате

Spots **EDY**

design: **U.T. EGOLUCE**

Faretti da incasso con LED arretrato realizzati in due dimensioni per consentire l'utilizzo di varie sorgenti luminose.

Caratteristiche:

- Installazione ad incasso su controsoffitto tramite molle.
- Installazione ad incasso con cassaforma per muratura.
- Sorgenti: GU10, Modulo LED COB e Modulo Power LED.
- IP 44 utilizzando Modulo LED COB 0108/IP.
- Ottiche disponibili: Led COB 24°,40° e 60° Power LED 10°,25° e 40°.
- Temperature di colore: 2700, 3000, 4000 e 5000K.
- Finiture disponibili: Bianco, Grigio, Oro Satinato, Cromo e Nickel Matt.
- Dimmerazione: DALI, Push, 1-10V e CASAMBI.
- Gruppo d'emergenza.
- CRI>90 a richiesta nelle versioni LED COB

Recessed spots with retrofit LED made in two dimensions to allow the use of different lighting sources.

Features:

- Recessed installation on the false ceiling through springs.
- Recessed installation with recessed boxes for wall.
- Sources: GU10, Modulo LED COB and Modulo Power LED.
- IP 44 using the Modulo LED COB 0108/IP.
- Beam angles available: LED COB 24°,40° and 60° Power LED 10°, 25° and 40°.
- Colours temperatures: 2700, 3000, 4000 and 5000K.
- Finitures available: White, Grey, Satin gold, Chrome and Nickel Matt.
- Dimmer: DALI, Push, 1-10V and CASAMBI.
- Emergency group.
- CRI>90 upon request in the LED COB version.

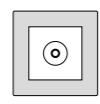
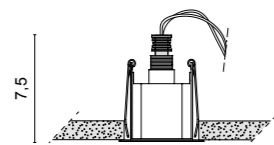

6,3 x 6,3

5,2 x 5,2 cm.

6298 Edy mini

- .01 Bianco - White
- .31 Cromato - Chromed
- .32 Nickel satinato - Nickel mat

Color temperature	Light sources	lm
/W 4000K	LED max 2W 500mA	209lm
/WW 3000K	LED max 2W 500mA	199lm
/XW 2700K	LED max 2W 500mA	189lm

F ◊ ⊗ R 0,10 Kg

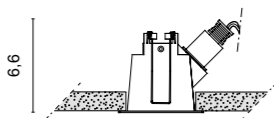

6,3 x 6,3

5,2 x 5,2 cm.

6299 Edy 45° mini

- .01 Bianco - White
- .31 Cromato - Chromed
- .32 Nickel satinato - Nickel mat

Color temperature	Light sources	lm
/W 4000K	LED max 2W 500mA	209lm
/WW 3000K	LED max 2W 500mA	199lm
/XW 2700K	LED max 2W 500mA	189lm

F ◊ ⊗ R 0,10 Kg



Accessori - Accessories



10x10,5x8,5h

0218

Cassaforma per calcestruzzo
Wallbox for concrete



13x10x0,7h

0219

Plaster kit traforato
Plaster kit perforated

Cod.	Drivers ON/OFF		
	0125 350mA	0127 500mA	0128 350mA
6298	1-6	1-6	1-10
6299	1-6	1-6	1-10

DIMMABLE drivers			
0141/DIM PUSH - 1...10V	0141/DALI DIM DALI	0145 DIM	0145/DALI DIM DALI
1-11 (500mA)	1-12 (350mA)	1-11 (500mA)	1-12 (350mA)
1-11 (500mA)	1-12 (350mA)	1-21	1-21

DIMMABLE drivers
wireless **Casambi**
0145/CASA

1-21	1-21
1-21	1-21

Solo collegamento in serie - Only serial connection



Art. 6699.31 Edy 45° mini

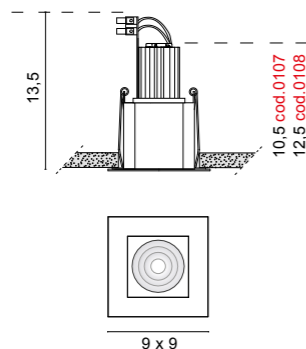

7,2 x 8,2 cm.

6305 Edy LED

- .01 Bianco - White
- .03 Grigio - Grey
- .25 Dorato satinato - Golded satin
- .31 Cromato - Chromed
- .32 Nickel satinato - Nickel mat

0,40 Kg

6305 + COB LED

Color temperature	Optics	Light sources	lm
0107/CW 5000K	/24 /40 /60	COB LED 6,1W 17,3V 350mA	1066lm
0107/W 4000K	/24 /40 /60	COB LED 6,1W 17,3V 350mA	975lm
0107/WW 3000K	/24 /40 /60	COB LED 6,1W 17,3V 350mA	939lm
0107/XW 2700K	/24 /40 /60	COB LED 6,1W 17,3V 350mA	896lm

0108/CW 5000K	/24 /40 /60	COB LED 8,9W 17,8V 500mA	1480lm
0108/W 4000K	/24 /40 /60	COB LED 8,9W 17,8V 500mA	1353lm
0108/WW 3000K	/24 /40 /60	COB LED 8,9W 17,8V 500mA	1303lm
0108/XW 2700K	/24 /40 /60	COB LED 8,9W 17,8V 500mA	1244lm

0108/W/IP 4000K	/24 /38 /58	COB LED IP44 8,9W 17,8V 500mA	1353lm
0108/WW/IP 3000K	/24 /38 /58	COB LED IP44 8,9W 17,8V 500mA	1303lm

6305 + POWER LED

Color temperature	Optics	Light sources	lm
0121 4000K	25°	POWER LED max 3x3W 700mA	846lm
0123 3000K	25°	POWER LED max 3x3W 700mA	804lm

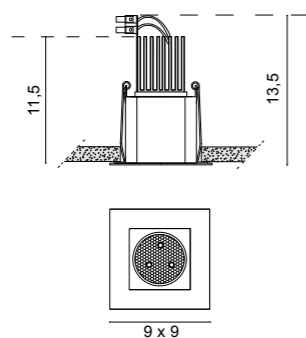

7,2 x 8,2 cm.



Accessori - Accessories



0199
Kit vetro diffusore sabbiato extrachiaro
Kit diffuser glass

Cod. LED	Drivers ON/OFF				DIMMABLE drivers				DIMMABLE drivers wireless Casambi		LED emergency unit
	0125 350mA	0147/COB 500mA	0149/COB 500mA	0126 700mA	0141/DIM PUSH - 1...10V	0141/DALI DIM DALI	0145/DALI DIM DALI	0145 DIM	0718/CASA	0145/CASA	0115/EM Inverter + Battery + LED indicator
0107 - COB LED	1	NO	NO	NO	1-2	1-2	1-3	1-3	1-2	1-3	1
0108 - COB LED	1	1-2	1	NO	1-2	1-2	1-3	1-3	1-2	1-3	1
0121 - POWER LED 1-2	1-2	1-4	NO	1-2	1-2	1-2	1-6	1-6	2-4	1-6	1
0123 - POWER LED 1-2	1-2	1-4	NO	1-2	1-2	1-2	1-6	1-6	2-4	1-6	1

Solo collegamento in serie - Only serial connection

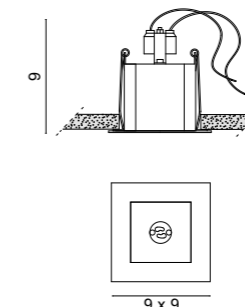

7,2 x 8,2 cm.

6302 Edy 230V

- .01 Bianco - White
- .03 Grigio - Grey
- .25 Dorato satinato - Golded satin
- .31 Cromato - Chromed
- .32 Nickel satinato - Nickel mat

Light sources
7W GU10 LED DIM (cod. 0104/16)
7W GU10 LED (cod. 0094/16)
max 50W GU10 (cod. 0072)

0,30 Kg



Accessori - Accessories



0199
Kit vetro diffusore sabbiato extrachiaro
Kit diffuser glass



0200
Cassaforma per calcestruzzo
Wallbox for concrete



0201
Plaster kit traforato
Plaster kit perforated



Spots DELTA MINI LED

design: U.T. EGOLUCE

Lampada ad incasso in metallo cromato verniciato o nichel satinato. Riflettore in alluminio. Diffusore in vetro sabbato extra-chiaro.

Recessed lamp in chromed, lacquered or nickel matt metal. Reflector aluminium. Frosted extra clear glass diffuser.

Lampe encastré en métal cromé, verni ou nickelé. Réflecteur en aluminium. Diffuseur en verre sablé extra clair.

Einbaudownlight aus Metall: verchromt, nickel matt oder lackiert. Reflektor aus Aluminium. Diffusor aus extraklarem sandbestrahltem Glas.

Встроенный даунлайт из хромированного, никелированного или окрашенного металла. Рефлектор из алюминия. Сверх яркое матовое защитное стекло

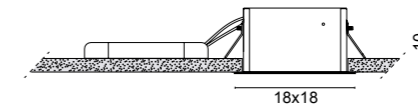

15,6x16,6 cm.

6492 Delta mini LED

- .01 Bianco - White
- .03 Grigio - Grey
- .31 Cromato - Chromed
- .32 Nickel satinato - Nickel mat

Color temperature	Light sources	lm
/W 4000K	LED 11,9W	1811lm
/WW 3000K	LED 11,9W	1701lm

IP40 R 1,50 Kg

A richiesta sono disponibili versioni dimmerabili con controllo CASAMBI. On request are available dimmable versions with CASAMBI control.

LED emergency unit

0115/EM

Inverter + Battery + LED indicator

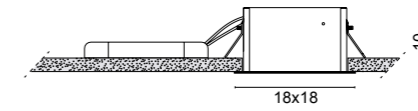
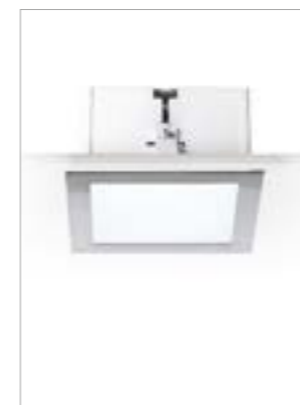

15,6x16,6 cm.

6492 Delta mini LED DIM

- .01 Bianco - White
- .03 Grigio - Grey
- .31 Cromato - Chromed
- .32 Nickel satinato - Nickel mat

Color temperature	Light sources	lm
/W/DIM 4000K	LED 11,9W	1811lm
/WW/DIM 3000K	LED 11,9W	1701lm

IP40 R 1,50 Kg

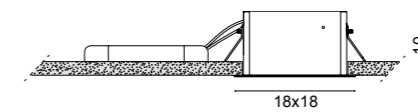
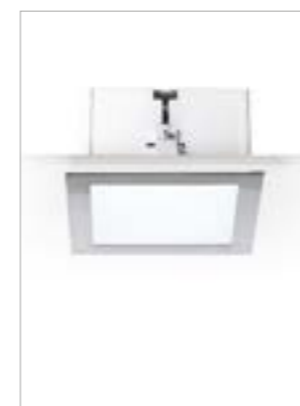

15,6x16,6 cm.

6492 Delta mini LED DIM DALI

- .01 Bianco - White
- .03 Grigio - Grey
- .31 Cromato - Chromed
- .32 Nickel satinato - Nickel mat

Color temperature	Light sources	lm
/W/DALI 4000K	LED 11,9W	1811lm
/WW/DALI 3000K	LED 11,9W	1701lm

IP40 R 1,50 Kg



Spots à encastrer en alu, avec source LED reculée, réalisés en plusieurs tailles différents pour pouvoir utiliser toutes sources lumineuses.

Caracteristiques:

- Installation sur faux plafond par des ressorts
- Versions rondes ou carrées
- Fixes ou réglables
- Sources: GU10 Module COB LED, module Power LED.
- IP 44 avec le module COB LED 0108/IP
- Faisceaux disponibles: COB LED: 24°, 40°, 60° Power LED: 10°, 25°, 40°
- Plusieurs tonalités de lumière (2700K, 3000K, 4000K et 5000K)
- Finitions disponibles: blanc, noir, gris, nickel satiné, chromé, doré, doré satiné
- Variateurs DALI, Push, 1-10V, et CASAMBI
- Unités d'urgence
- CRI>90 sur demande dans les versions COB LED

Focos empotrados fabricados en diferentes tamaños para permitir el uso de diversas fuentes de luz.

Características:

- Instalación empotrada en falso techo con muelles.
- Versión redonda y cuadrada.
- Fijo o ajustable.
- Fuentes: GU5,3 -GU10- Módulo LED COB y módulos LED de potencia.
- IP 44 con el módulo LED COB 0108 / IP.
- Óptica disponible: COB Led 24°, 40° y 60° - Power Led 10°, 25° y 40°.
- Temperaturas de color: 2700, 3000, 4000 y 5000K.
- Acabados disponibles: blanco, negro, gris, dorado, dorado satinado, níquel mate y cromo.
- Regulación Dimable: DALI, Push, 1-10V y CASAMBI.
- Grupo de emergencia.
- CRI> 90 a solicitud en versiones COB Led.

Einbaustrahler (dünnere Flansch) mit LED in verschiedenen Abmessungen, um die Verwendung unterschiedlicher Licht Quellen zu ermöglichen.

Eigenschaften:

- Einbau an der Zwischendecke durch Federn
- Rund oder eckig.
- Fest oder einstellbar
- Licht Quellen: GU5,3 - GU10 - Modul LED COB und Modul Power LED.
- IP 44 mit der Modul-LED COB 0108 / IP.
- Verfügbare Abstrahlwinkel: LED COB 24°, 40° und 60° - LED Power 10°, 25° und 40°.
- Farbtemperaturen: 2700, 3000, 4000 und 5000K ..
- Verfügbare Ausführungen: Weiß, Schwarz, Grau, Gold, Satin Gold, Nickel Matt und Chrom.
- Dimmer: DALI, Push, 1-10 V und CASAMBI.
- Notlicht Batterie.
- CRI> 90 auf Anfrage in der LED-COB-Version.

Встроенные споты в разных размерах и с разными источниками света

Характеристики:

- монтаж в подвесной потолок с помощью пружин
- круглые или квадратные
- фиксированные или ориентируемые
- источники света: GU 5,3, GU10, светодиодный модуль на плате, мощный светодиод
- IP44 в модели со светодиодом на плате 0108/IP
- пучки света для светодиода на плате 24, 40, 60 градусов; для мощного светодиода 10, 25 и 40 градусов
- цветовая температура 2700, 3000, 4000 и 5000K
- цвета: белый, черный, серый, золото, матовое золото, хром и матовый никель
- диммирование: DALI, кнопка push, 1-10в и Casa Ambì
- аварийное питание
- по запросу CRI>90 для варианта светодиод на плате

Spots **GEKO**

design: U.T. EGOLUCE

Faretti da incasso realizzati in diverse dimensioni per consentire l'utilizzo di varie sorgenti luminose.

Caratteristiche:

- Installazione ad incasso su controsoffitto tramite molle.
- Versione Tonda e Quadrata.
- Fissi o orientabili.
- Sorgenti: GU5,3 GU10 Modulo LED COB e Moduli Power LED.
- IP 44 utilizzando Modulo LED COB 0108/IP.
- Ottiche disponibili: LED COB 24°, 40° e 60° Power LED 10°, 25° e 40°.
- Temperature di colore: 2700, 3000, 4000 e 5000K.
- Finiture disponibili: Bianco, Nero, Grigio, Oro, Oro Satinato, Nickel Matt e Cromo.
- Dimmerazione: DALI, Push, 1-10V e CASAMBI.
- Gruppo d'emergenza .
- CRI>90 a richiesta nelle versioni LED COB.

Recessed spots (thin flange) with backward LED made in different dimensions to allow the use of different lighting sources.

Features:

- Recessed installation on the false ceiling through springs
- Round or square.
- Fixed or adjustable
- Sources: GU5,3 GU10 Module Led COB and Modules Power LED.
- IP 44 using the Module LED COB 0108/IP.
- Beam angles available: LED COB 24°, 40° and 60° Power LED 10°, 25° and 40°.
- Colours temperatures: 2700, 3000, 4000 and 5000K.
- Finitures available: White, Black, Grey, Gold, Satin Gold, Nickel Matt and Chrome.
- Dimmer: DALI, Push, 1-10V e CASAMBI.
- Emergency group.
- CRI>90 upon request in the LED COB version.

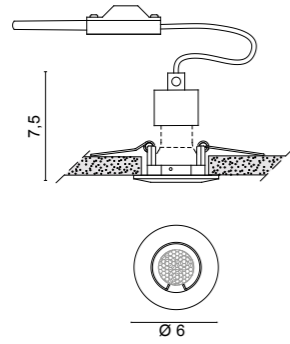

6.5 cm.

6680 Geko mini

- .01 Bianco - White
- .02 Nero - Black
- .21 Dorato lucido - Shiny golded
- .31 Cromato - Chromed
- .32 Nickel satinato - Nickel mat

Light sources

3W GU10 LED (cod. 0093/19)



0,11 Kg

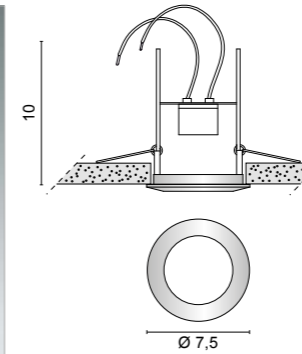

6.6 cm.

6290 Geko 230

- .01 Bianco - White
- .02 Nero - Black
- .21 Dorato lucido - Shiny golded
- .25 Dorato satinato - Golded satin
- .31 Cromato - Chromed
- .32 Nickel satinato - Nickel mat

Light sources

7W GU10 LED DIM (cod. 0104/16)

7W GU10 LED (cod. 0094/16)

max 50W GU10 (cod. 0072)



0,11 Kg

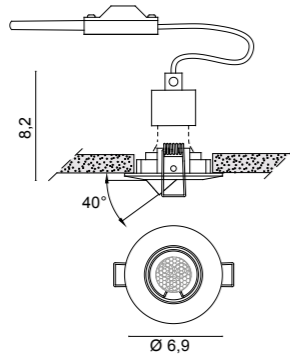

6 cm.

6681 Geko mini Adjustable

- .01 Bianco - White
- .02 Nero - Black
- .21 Dorato lucido - Shiny golded
- .31 Cromato - Chromed
- .32 Nickel satinato - Nickel mat

Light sources

3W GU10 LED (cod. 0093/19)



0,11 Kg

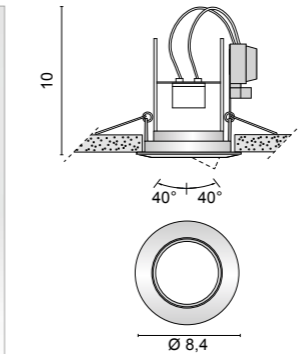

7.5 cm.

6455 Geko Adjustable 230

- .01 Bianco - White
- .02 Nero - Black
- .03 Grigio - Grey
- .21 Dorato lucido - Shiny golded
- .25 Dorato satinato - Golded satin
- .31 Cromato - Chromed
- .32 Nickel satinato - Nickel mat

Light sources

7W GU10 LED DIM (cod. 0104/16)

7W GU10 LED (cod. 0094/16)

max 50W GU10 (cod. 0072)



0,04 Kg

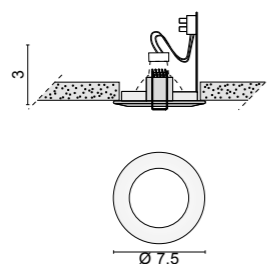

- 6460 Geko**
- .01 Bianco - White
 - .02 Nero - Black
 - .21 Dorato lucido - Shiny golded
 - .25 Dorato satinato - Golded satin
 - .31 Cromato - Chromed
 - .32 Nickel satinato - Nickel mat

Light sources
12V 50W GU5.3

0,08 Kg

6,6 cm.

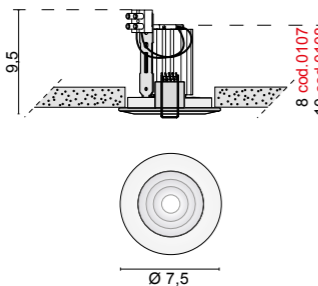

6460 + COB LED

Color temperature	Optics	Light sources	lm
0107/CW 5000K	I24 I40 I60	COB LED 6,1W 17,3V 350mA	1066lm
0107/W 4000K	I24 I40 I60	COB LED 6,1W 17,3V 350mA	975lm
0107/WW 3000K	I24 I40 I60	COB LED 6,1W 17,3V 350mA	939lm
0107/XW 2700K	I24 I40 I60	COB LED 6,1W 17,3V 350mA	896lm

0108/CW 5000K	I24 I40 I60	COB LED 8,9W 17,8V 500mA	1480lm
0108/W 4000K	I24 I40 I60	COB LED 8,9W 17,8V 500mA	1353lm
0108/WW 3000K	I24 I40 I60	COB LED 8,9W 17,8V 500mA	1303lm
0108/XW 2700K	I24 I40 I60	COB LED 8,9W 17,8V 500mA	1244lm

0108/W/IP 4000K	I24 I38 I58	COB LED IP44 8,9W 17,8V 500mA	1353lm
0108/WW/IP 3000K	I24 I38 I58	COB LED IP44 8,9W 17,8V 500mA	1303lm

6,6 cm.

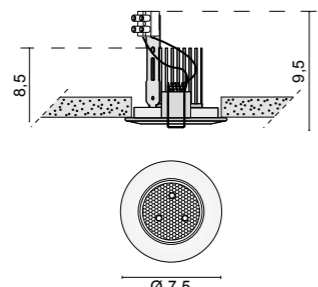

6460 + POWER LED

Color temperature	Optics	Light sources	lm
0121 4000K	25°	POWER LED max 3x3W 700mA	846lm
0123 3000K	25°	POWER LED max 3x3W 700mA	804lm

6,6 cm.

Accessori - Accessories



0183
Dischi reggi lampadina in metacrilato solo per il fissaggio del modulo LED.
Methacrylate disks
only for fixing LED module.

.31/TR Trasparente - Clear

.31/ST Satinato - Satin

Cod. LED	Drivers ON/OFF				DIMMABLE drivers				DIMMABLE drivers wireless Casambi		LED emergency unit
	0125 350mA	0147/COB 500mA	0149/COB 500mA	0126 700mA	0141/DIM PUSH - 1...10V	0141/DALI DIM DALI	0145/DALI DIM DALI	0145 DIM	0718/CASA	0145/CASA	
0107 - COB LED	1	NO	NO	NO	1-2	1-2	1-3	1-3	1-2	1-3	1
0108 - COB LED	1	1-2	1	NO	1-2	1-2	1-3	1-3	1-2	1-3	1
0121 - POWER LED	1-2	1-4	NO	1-2	1-2	1-2	1-6	1-6	2-4	1-6	1
0123 - POWER LED	1-2	1-4	NO	1-2	1-2	1-2	1-6	1-6	2-4	1-6	1

Solo collegamento in serie - Only serial connection

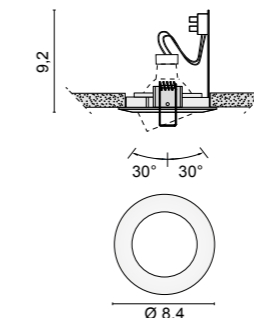

- 6447 Geko Adjustable**
- .01 Bianco - White
 - .02 Nero - Black
 - .03 Grigio - Grey
 - .21 Dorato lucido - Shiny golded
 - .25 Dorato satinato - Golded satin
 - .31 Cromato - Chromed
 - .32 Nickel satinato - Nickel mat

Light sources
12V 50W GU5.3

0,13 Kg

7,5 cm.

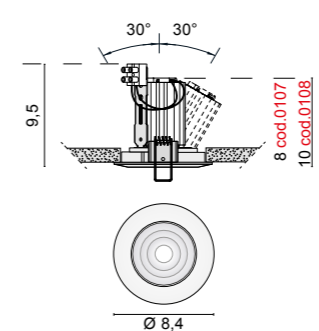

6447 + COB LED

Color temperature	Optics	Light sources	lm
0107/CW 5000K	I24 I40 I60	COB LED 6,1W 17,3V 350mA	1066lm
0107/W 4000K	I24 I40 I60	COB LED 6,1W 17,3V 350mA	975lm
0107/WW 3000K	I24 I40 I60	COB LED 6,1W 17,3V 350mA	939lm
0107/XW 2700K	I24 I40 I60	COB LED 6,1W 17,3V 350mA	896lm

0108/CW 5000K	I24 I40 I60	COB LED 8,9W 17,8V 500mA	1480lm
0108/W 4000K	I24 I40 I60	COB LED 8,9W 17,8V 500mA	1353lm
0108/WW 3000K	I24 I40 I60	COB LED 8,9W 17,8V 500mA	1303lm
0108/XW 2700K	I24 I40 I60	COB LED 8,9W 17,8V 500mA	1244lm

0108/W/IP 4000K	I24 I38 I58	COB LED IP44 8,9W 17,8V 500mA	1353lm
0108/WW/IP 3000K	I24 I38 I58	COB LED IP44 8,9W 17,8V 500mA	1303lm

7,5 cm.

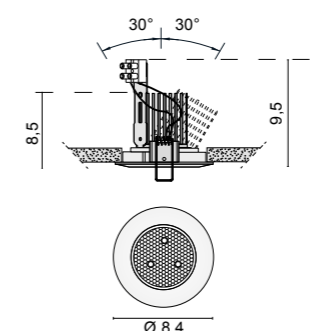
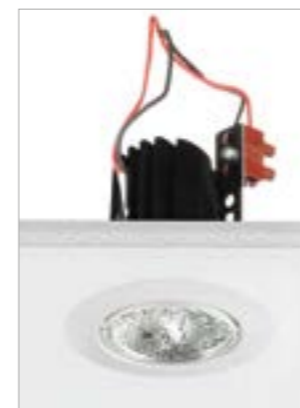

6447 + POWER LED

Color temperature	Optics	Light sources	lm
0121 4000K	25°	POWER LED max 3x3W 700mA	846lm
0123 3000K	25°	POWER LED max 3x3W 700mA	804lm

7,5 cm.

Accessori - Accessories



0183
Dischi reggi lampadina in metacrilato solo per il fissaggio del modulo LED.
Methacrylate disks
only for fixing LED module.

.31/TR Trasparente - Clear

.31/ST Satinato - Satin

Cod. LED	Drivers ON/OFF				DIMMABLE drivers				DIMMABLE drivers wireless Casambi		LED emergency unit
	0125 350mA	0147/COB 500mA	0149/COB 500mA	0126 700mA	0141/DIM PUSH - 1...10V	0141/DALI DIM DALI	0145/DALI DIM DALI	0145 DIM	0718/CASA	0145/CASA	
0107 - COB LED	1	NO	NO	NO	1-2	1-2	1-3	1-3	1-2	1-3	1
0108 - COB LED	1	1-2	1	NO	1-2	1-2	1-3	1-3	1-2	1-3	1
0121 - POWER LED	1-2	1-4	NO	1-2	1-2	1-2	1-6	1-6	2-4	1-6	1
0123 - POWER LED	1-2	1-4	NO	1-2	1-2	1-2	1-6	1-6	2-4	1-6	1

Solo collegamento in serie - Only serial connection

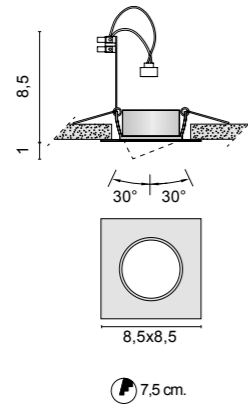

6048 Geko quadro

- .01** Bianco - White
- .02** Nero - Black
- .21** Dorato lucido - Shiny golded
- .25** Dorato satinato - Golded satin
- .31** Cromato - Chromed
- .32** Nickel satinato - Nickel mat

Light sources
12V 50W GU5.3



0,10 Kg

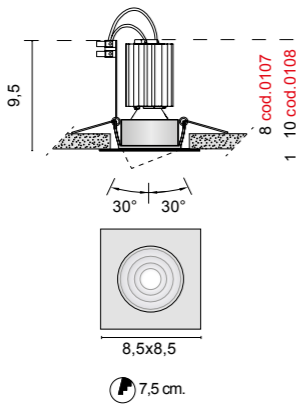

6048 + COB LED

	Color temperature	Optics	Light sources	lm
0107/CW	5000K	/24 /40 /60	COB LED 6,1W 17,3V 350mA	1066lm
0107/W	4000K	/24 /40 /60	COB LED 6,1W 17,3V 350mA	975lm
0107/WW	3000K	/24 /40 /60	COB LED 6,1W 17,3V 350mA	939lm
0107/XW	2700K	/24 /40 /60	COB LED 6,1W 17,3V 350mA	896lm
0108/CW	5000K	/24 /40 /60	COB LED 8,9W 17,8V 500mA	1480lm
0108/W	4000K	/24 /40 /60	COB LED 8,9W 17,8V 500mA	1353lm
0108/WW	3000K	/24 /40 /60	COB LED 8,9W 17,8V 500mA	1303lm
0108/XW	2700K	/24 /40 /60	COB LED 8,9W 17,8V 500mA	1244lm
0108/W/IP	4000K	/24 /38 /58	COB LED IP44 8,9W 17,8V 500mA	1353lm
0108/WW/IP	3000K	/24 /38 /58	COB LED IP44 8,9W 17,8V 500mA	1303lm

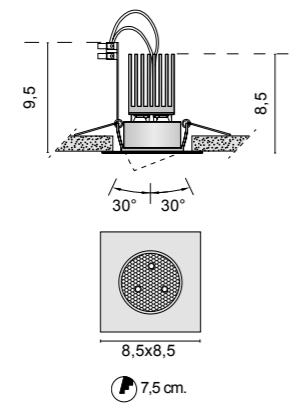

6048 + POWER LED

	Color temperature	Optics	Light sources	lm
0121	4000K	25°	POWER LED max 3x3W 700mA	846lm
0123	3000K	25°	POWER LED max 3x3W 700mA	804lm

Accessori - Accessories



0183

Dischi reggi lampadina in metacrilato solo per il fissaggio del modulo LED.
Methacrylate disks only for fixing LED module.

.31/TR Trasparente - Clear

.31/ST Satinato - Satin

Cod. LED	Drivers ON/OFF				DIMMABLE drivers				DIMMABLE drivers wireless Casambi		LED emergency unit
	0125 350mA	0147/COB 500mA	0149/COB 500mA	0126 700mA	0141/DIM PUSH - 1...10V	0141/DALI DIM DALI	0145/DALI DIM DALI	0145 DIM	0718/CASA	0145/CASA	0115/EM Inverter + Battery + LED indicator
0107 - COB LED	1	NO	NO	NO	1-2	1-2	1-3	1-3	1-2	1-3	1
0108 - COB LED	1	1-2	1	NO	1-2	1-2	1-3	1-3	1-2	1-3	1
0121 - POWER LED	1-2	1-4	NO	1-2	1-2	1-2	1-6	1-6	2-4	1-6	1
0123 - POWER LED	1-2	1-4	NO	1-2	1-2	1-2	1-6	1-6	2-4	1-6	1

Solo collegamento in serie - Only serial connection

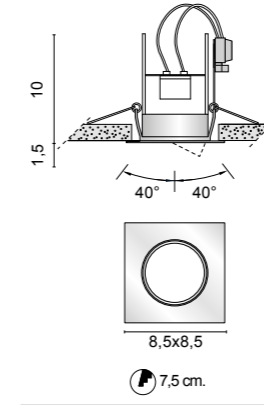

6056 Geko quadro 230V

- .01** Bianco - White
- .02** Nero - Black
- .21** Dorato lucido - Shiny golded
- .25** Dorato satinato - Golded satin
- .31** Cromato - Chromed
- .32** Nickel satinato - Nickel mat

Light sources

7W GU10 LED DIM (cod. 0104/16)
7W GU10 LED (cod. 0094/16)
max 50W GU10 (cod. 0072)



0,15 Kg

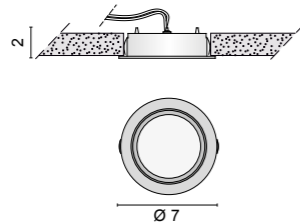

**6365** Zen LED

.01	Bianco - White
.21	Dorato lucido - Shiny golded
.31	Cromato - Chromed
.32	Nickel satinato - Nickel mat

Color temperature	Light sources	lm
/W 4000K	LED max 2W 500mA	209lm
/WW 3000K	LED max 2W 500mA	199lm
/XW 2700K	LED max 2W 500mA	189lm

				0,07 Kg
--	--	--	--	---------

6 cm.

Accessori - Accessories

**0232**

Cassaforma da parete (solo per **6365**)
Wall plastic box (only for **6365**)

Cod.	Drivers ON/OFF		
	0125	0128	0127
6365	350mA	350mA	500mA
	1-6	1-10	1-6

DIMMABLE drivers			
0141/DIM	0141/DALI	0145/DALI	0145
PUSH - 1...10V	DIM DALI	DIM DALI	DIM
1-11	1-11	1-21	1-21

DIMMABLE drivers wireless **Casambi**
0145/CASA

1-21

Solo collegamento in serie - Only serial connection

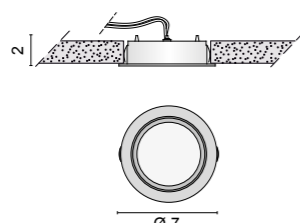
**6251** Zen

.01	Bianco - White
.21	Dorato lucido - Shiny golded
.31	Cromato - Chromed
.32	Nickel satinato - Nickel mat

Light sources
12V 20W G4

		0,07 Kg
--	--	---------

6 cm.

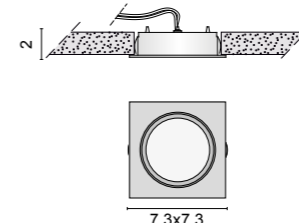
**.01** Bianco - White**.21** Dorato lucido
Shiny golded**.31** Cromato
Chromed**.32** Nickel satinato
Nickel mat**6398** Modus LED

.01	Bianco - White
.21	Dorato lucido - Shiny golded
.31	Cromato - Chromed
.32	Nickel satinato - Nickel mat

Color temperature	Light sources	lm
/W 4000K	LED max 2W 500mA	209lm
/WW 3000K	LED max 2W 500mA	199lm
/XW 2700K	LED max 2W 500mA	189lm

				0,07 Kg
--	--	--	--	---------

6 cm.

Accessori - Accessories

**0232**

Cassaforma da parete (solo per **6398**)
Wall plastic box (only for **6398**)

Cod.	Drivers ON/OFF		
	0125	0128	0127
6398	350mA	350mA	500mA
	1-6	1-10	1-6

DIMMABLE drivers			
0141/DIM	0141/DALI	0145/DALI	0145
PUSH - 1...10V	DIM DALI	DIM DALI	DIM
1-11	1-11	1-21	1-21

DIMMABLE drivers wireless **Casambi**
0145/CASA

1-21

Solo collegamento in serie - Only serial connection

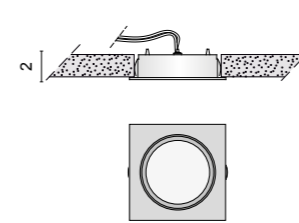
**6265** Modus

.01	Bianco - White
.21	Dorato lucido - Shiny golded
.31	Cromato - Chromed
.32	Nickel satinato - Nickel mat

Light sources
12V 20W G4

		0,07 Kg
--	--	---------

6 cm.

**.01** Bianco - White**.21** Dorato lucido
Shiny golded**.31** Cromato
Chromed**.32** Nickel satinato
Nickel mat

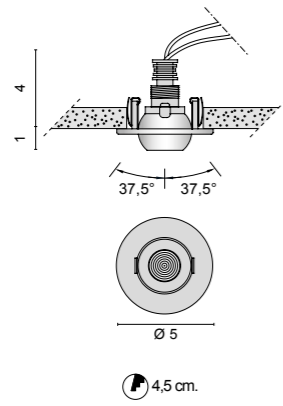

6324 Occhio LED

- .01 Bianco - White
- .21 Dorato lucido - Shiny golded
- .31 Cromato - Chromed
- .32 Nickel satinato - Nickel mat

Color temperature	Light sources	lm
/W 4000K	LED 1W 350mA	151lm
/WW 3000K	LED 1W 350mA	143lm

IP 40 0,09 Kg

Cod.	Drivers ON/OFF	
	0125	0128
6324	1-6	1-10

DIMMABLE drivers			
0141/DIM	0141/DALI	0145/DALI	0145
PUSH - 1...10V	DIM DALI	DIM DALI	DIM
1-12	1-12	1-21	1-21

DIMMABLE drivers wireless **Casambi** **0145/CASA**

Solo collegamento in serie - Only serial connection

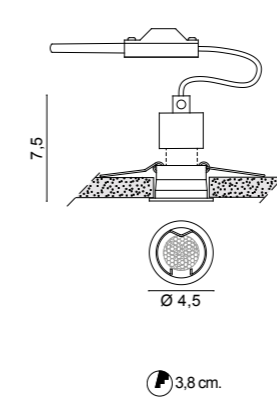

6234 Tubo mini

- .01 Bianco - White
- .02 Nero - Black
- .21 Dorato lucido - Shiny golded
- .31 Cromato - Chromed
- .32 Nickel satinato - Nickel mat

Color temperature	Light sources	lm
/W 4000K	LED max 2W 500mA	209lm
/WW 3000K	LED max 2W 500mA	199lm
/XW 2700K	LED max 2W 500mA	189lm

IP 40 0,04 Kg

Cod.	Drivers ON/OFF	
	0125	0128
6234	1-6	1-10

DIMMABLE drivers			
0141/DIM	0141/DALI	0145/DALI	0145
PUSH - 1...10V	DIM DALI	DIM DALI	DIM
1-12	1-12	1-21	1-21

DIMMABLE drivers wireless **Casambi** **0145/CASA**

SNORKY Incasso

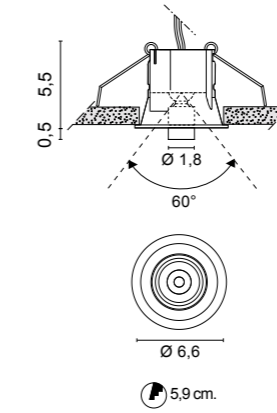

6698 Snorky incasso

- .01 Bianco - White
- .02 Nero - Black

Color temperature	Light sources	lm
/W 4000K	LED max 2W 500mA	209lm
/WW 3000K	LED max 2W 500mA	199lm
/XW 2700K	LED max 2W 500mA	189lm

IP 40 0,12 Kg

Accessori - Accessories



0221
Plaster kit traforato 12,5 x 9
Plaster kit preforated 12,5 x 9



Cod.	Drivers ON/OFF		
	0125	0128	0127
6698	1-6	1-10	1-6

DIMMABLE drivers			
0141/DIM	0141/DALI	0145/DALI	0145
PUSH - 1...10V	DIM DALI	DIM DALI	DIM
1-11	1-11	1-21	1-21

DIMMABLE drivers wireless **Casambi** **0145/CASA**

Solo collegamento in serie - Only serial connection

CORNO mini 230V

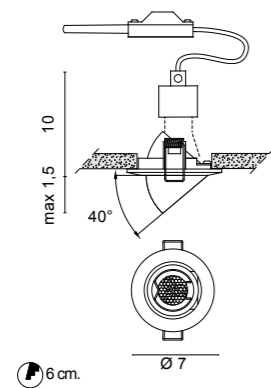

- 6238** Corno mini 230V
- .01 Bianco - White
 - .21 Dorato lucido - Shiny golded
 - .31 Cromato - Chromed
 - .32 Nickel satinato - Nickel mat

Light sources
 3W GU10 LED (cod. 0093/19)



0,07 Kg

6 cm.

EOS PIU'

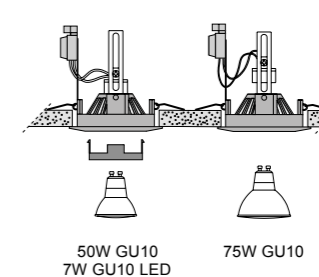
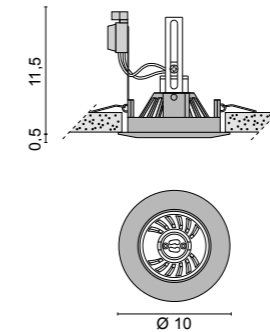

- 6263** Eos più
- .01 Bianco - White
 - .21 Dorato lucido - Shiny golded
 - .31 Cromato - Chromed
 - .32 Nickel satinato - Nickel mat

Light sources
 7W GU10 LED DIM (cod. 0104/16)
 7W GU10 LED (cod. 0094/16)
 50W GU10 (cod. 0072)
 75W GU10

0,20 Kg

8 cm.

CORNO 12V

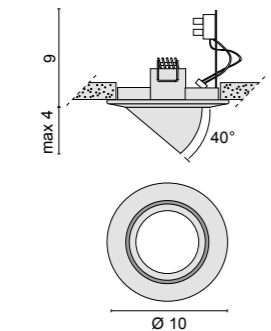

- 6240** Corno 12V
- .01 Bianco - White
 - .21 Dorato lucido - Shiny golded
 - .31 Cromato - Chromed
 - .32 Nickel satinato - Nickel mat

Light sources
 12V 50W GU 5,3



0,15 Kg

8,5 cm.

GAMMA

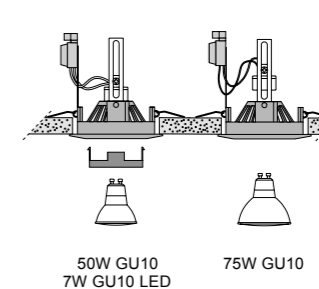
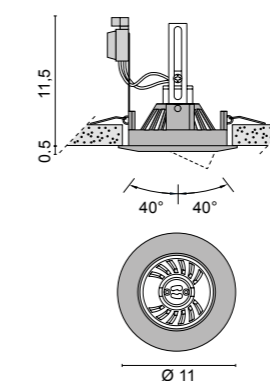

- 6249** Gamma
- .01 Bianco - White
 - .21 Dorato lucido - Shiny golded
 - .31 Cromato - Chromed
 - .32 Nickel satinato - Nickel mat

Light sources
 7W GU10 LED DIM (cod. 0104/16)
 7W GU10 LED (cod. 0094/16)
 50W GU10 (cod. 0072)
 75W GU10

0,25 Kg

9,7 cm.

CORNO 230V

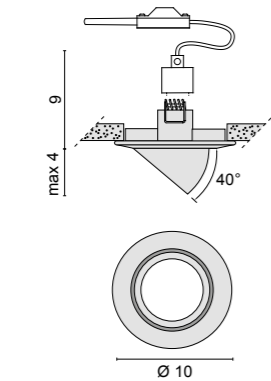

- 6241** Corno 230V
- .01 Bianco - White
 - .21 Dorato lucido - Shiny golded
 - .31 Cromato - Chromed
 - .32 Nickel satinato - Nickel mat

Light sources
 7W GU10 LED DIM (cod. 0104/16)
 7W GU10 LED (cod. 0094/16)
 max 50W GU10 (cod. 0072)



0,20 Kg

8,5 cm.

STELLA

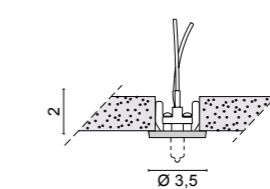

- 6204** Stella
- .01 Bianco - White
 - .02 Nero - Black
 - .21 Dorato lucido - Shiny golded
 - .31 Cromato - Chromed
 - .32 Nickel satinato - Nickel mat

Light sources
 12V 10W G4

0,03 Kg

2,6 cm.

SPECCHIO *incasso*

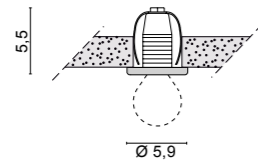

6024 Specchio incasso

- .01 Bianco - White
- .31 Cromato - Chromed
- .32 Nickel satinato - Nickel mat

Light sources

- 6W E14 LED (cod. 0105/MINI)
- 28W E14 ECO

▽ 0,07 Kg

⌀ 4,5 cm.



.01 Bianco - White



.31 Cromato
Chromed



.32 Nickel satinato
Nickel mat

SPECCHIO *corto*

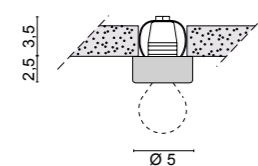

6030 Specchio corto

- .01 Bianco - White
- .31 Cromato - Chromed
- .32 Nickel satinato - Nickel mat

Light sources

- 6W E14 LED (cod. 0105/MINI)
- 28W E14 ECO

▽ 0,07 Kg

⌀ 3,5 cm.



.01 Bianco - White



.22 Dorato lucido
Shiny golded



.32 Nickel satinato
Nickel mat

SPECCHIO *lungo*

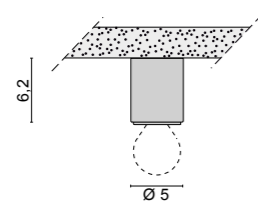

6028 Specchio lungo

- .01 Bianco - White
- .31 Cromato - Chromed
- .32 Nickel satinato - Nickel mat

Light sources

- 6W E14 LED (cod. 0105/MINI)
- 28W E14 ECO

▽ 0,10 Kg



.01 Bianco - White



.31 Cromato
Chromed



.32 Nickel satinato
Nickel mat



	pag
STAR ZERO	76
QUADRATO 230V	78
QUADRATO LED	79
CASPER 230V	80
CASPER LED	81
GHOST MINI LED	82
GHOST LED	83
GHOST MAXI LED	84
ROTONDO	86
ROTONDO 230V	87
ZERO 230V	88
ZERO LED	89
MIRAGE MINI LED	90
MIRAGE LED	91
MIRAGE MAXI LED	92
NIHIL TONDO MINI 230V	94
NIHIL TONDO 230V	95
NIHIL TONDO LED	95
NIHIL QUADRO MINI 230V	96
NIHIL QUADRO 230V	97
NIHIL QUADRO LED	97
PHANTOM SYSTEM	100
PHANTOM SYSTEM DIMM 1...10V	104
PHANTOM SYSTEM DIMM DALI	104

Collezione di lampade da incasso a scomparsa totale per installazioni in soffitti di cartongesso.
L'installazione prevede operazioni di stuccatura, rasatura e verniciatura.
Il risultato finale è la completa integrazione del corpo luce con l'architettura senza la presenza di sporgenze o cornici esterne. Disponibili in varie forme, dimensioni e differenti soluzioni di luce.

Collection of recessed trimless lamps for installations in plasterboard ceilings.
The installation involves grouting, smoothing and painting.
The end result is the complete integration of the body with the architecture without the presence of external frames.
Available in various shapes, sizes and different light solutions.

Collection de lampes encastrées totalement disparues pour une installation dans des plafonds en plaques de plâtre.
L'installation comprend le jointoiment, le rasage et la peinture.
Le résultat final est l'intégration complète du corps de lumière avec l'architecture sans la présence de saillies ou de cadres externes. Disponible en différentes formes, tailles et différentes solutions d'éclairage.

Colección de lámparas empotradas totalmente desaparecidas para instalación en techos de pladur.
La instalación implica lechada, afeitado y pintura.
El resultado final es la integración completa del cuerpo de luz con la arquitectura sin la presencia de protuberancias o marcos externos. Disponible en varias formas, tamaños y diferentes soluciones de luz.

Einbauleuchtsammlung zum Einbau in komplett verschwindende Gipskartondecken.
Die Installation beinhaltet Verfugen, Glätten und Streichen.
Das Endergebnis ist die vollständige Integration des Lichtkörpers in die Architektur, ohne dass Vorsprünge oder äußere Rahmen vorhanden sind. Erhältlich in verschiedenen Formen, Größen und verschiedenen Lichtlösungen.

Коллекция встраиваемых светильников для установки в полностью исчезающих гипсокартонных потолках.
Установка включает затирку, бритье и покраску.
Конечным результатом является полная интеграция светового тела с архитектурой без наличия выступов или внешних рам. Доступный в различных формах, размерах и различных световых решениях.



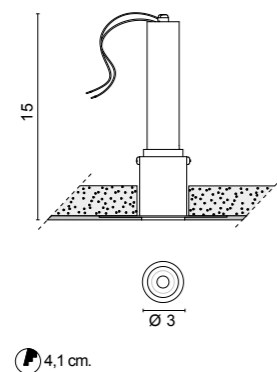

6689 Star zero
 .01 Bianco - White
 .02 Nero - Black

Color temperature	Optics	Light sources	lm
<i>/W</i> 4000K	<i>/35 /48 /63</i>	LED 6,1W 17,3V 350mA	975lm
<i>/W</i> 4000K	<i>/ST</i> Satinato - Satin	LED 6,1W 17,3V 350mA	975lm
<i>/WW</i> 3000K	<i>/35 /48 /63</i>	LED 6,1W 17,3V 350mA	939lm
<i>/WW</i> 3000K	<i>/ST</i> Satinato - Satin	LED 6,1W 17,3V 350mA	939lm
<i>/XW</i> 2700K	<i>/35 /48 /63</i>	LED 6,1W 17,3V 350mA	896lm
<i>/XW</i> 2700K	<i>/ST</i> Satinato - Satin	LED 6,1W 17,3V 350mA	896lm



0,30 Kg

IP44 a richiesta. - IP44 upon request.



Cod.	Drivers ON/OFF			DIMMABLE drivers				DIMMABLE drivers wireless Casambi		LED emergency unit
	0136/15 *	0125	0128	0141/DIM	0141/DALI	0145	0145/DALI	0718/CASA	0145/CASA	0115/EM
6689	350mA	350mA	350mA	PUSH - 1...10V	DIM DALI	DIM	DIM DALI	1-2	1-3	Inverter + Battery + LED indicator
	1-2	1	1-2	1-2	1-2	1-3	1-3	1-2	1-3	1

Solo collegamento in serie - Only serial connection

* I drivers 0136/15 può passare dal foro incasso del faretto. Il driver 0136/15 può essere inserito anche con cassaforma montata.

Driver 0136/15 can pass through the recessed hole of the spotlight. The driver 0136/15 can also be inserted with a mounted formwork.

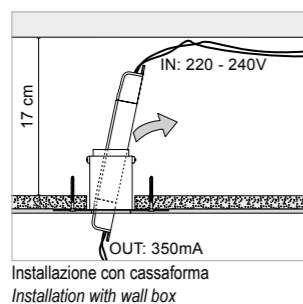

Installazione con cassaforma
 Installation with wall box

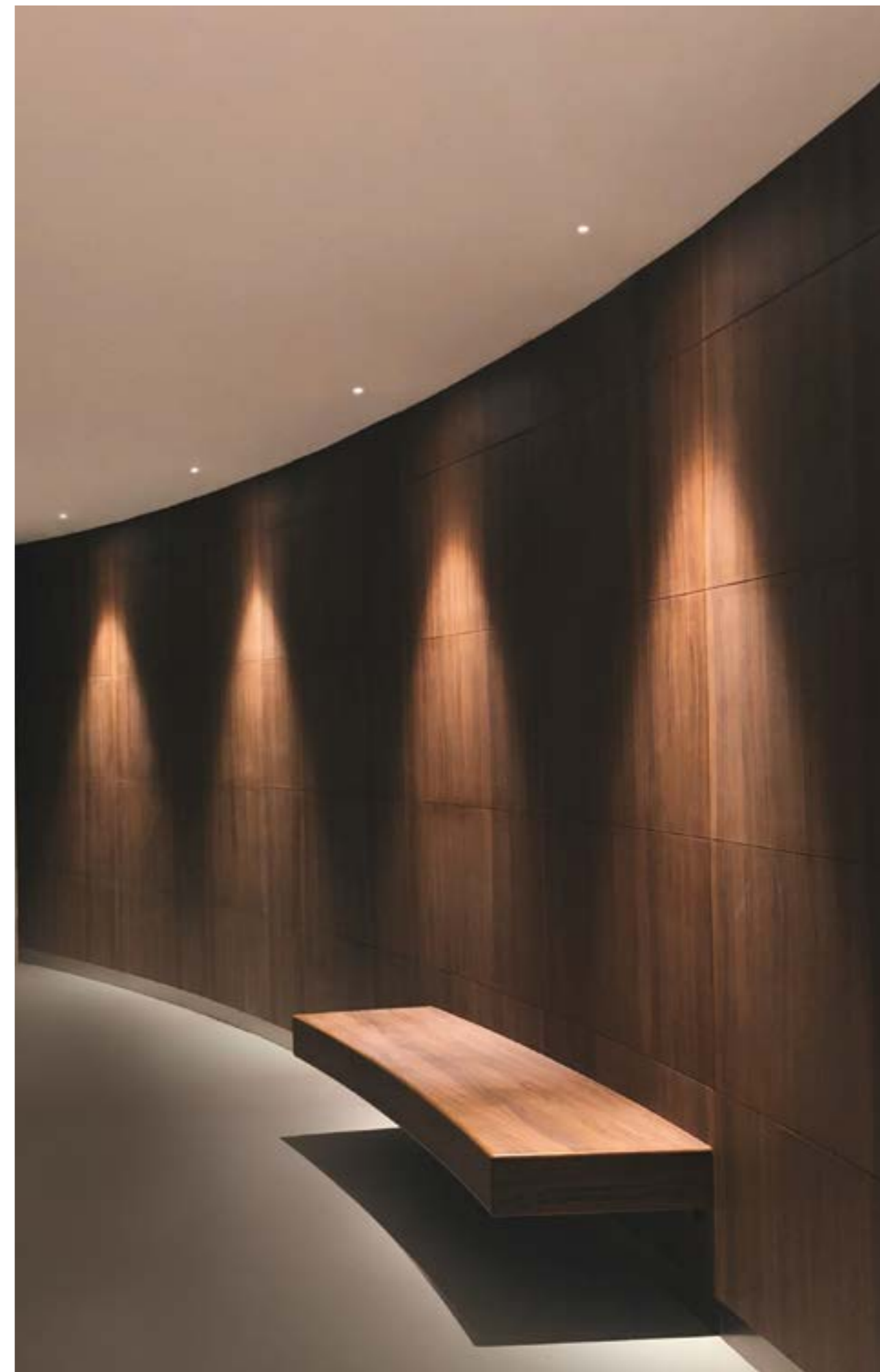

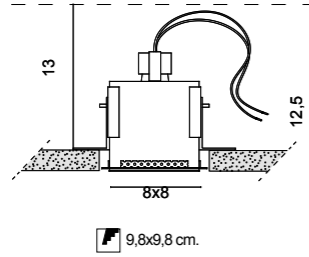

6627 Quadrato 230V
.01 Bianco - White

Light sources
 7W GU10 LED DIM (cod. 0104/16)
 7W GU10 LED (cod. 0094/16)
 max 50W GU10 (cod. 0072)

0,3m
 0,70 Kg

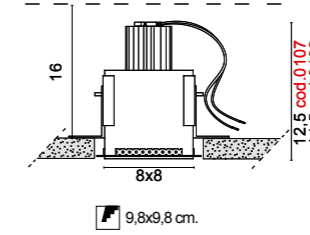

6628 Quadrato LED
.01 Bianco - White

0,80 Kg



6628 + COB LED

Color temperature	Optics	Light sources	lm
0107/CW 5000K	/24 /40 /60	COB LED 6,1W 17,3V 350mA	1066lm
0107/W 4000K	/24 /40 /60	COB LED 6,1W 17,3V 350mA	975lm
0107/WW 3000K	/24 /40 /60	COB LED 6,1W 17,3V 350mA	939lm
0107/XW 2700K	/24 /40 /60	COB LED 6,1W 17,3V 350mA	896lm
0108/CW 5000K	/24 /40 /60	COB LED 8,9W 17,8V 500mA	1480lm
0108/W 4000K	/24 /40 /60	COB LED 8,9W 17,8V 500mA	1353lm
0108/WW 3000K	/24 /40 /60	COB LED 8,9W 17,8V 500mA	1303lm
0108/XW 2700K	/24 /40 /60	COB LED 8,9W 17,8V 500mA	1244lm
0108/W/IP 4000K	/24 /38 /58	COB LED IP44 8,9W 17,8V 500mA	1353lm
0108/WW/IP 3000K	/24 /38 /58	COB LED IP44 8,9W 17,8V 500mA	1303lm

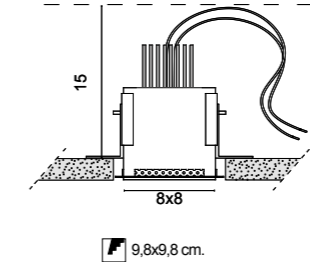

6628 + POWER LED

Color temperature	Optics	Light sources	lm
0121 4000K	25°	POWER LED max 3x3W 700mA	846lm
0123 3000K	25°	POWER LED max 3x3W 700mA	804lm

Cod. LED	Drivers ON/OFF				DIMMABLE drivers				DIMMABLE drivers wireless Casambi		LED emergency unit
	0125 350mA	0128 350mA	0147/COB 500mA	0126 700mA	0141/DIM PUSH - 1...10V	0141/DALI DIM DALI	0145/DALI DIM DALI	0145 DIM	0718/CASA	0145/CASA	0115/EM Inverter + Battery + LED indicator
0107 - COB LED	1	1-2	NO	NO	1-2	1-2	1-3	1-3	1-2	1-3	1
0108 - COB LED	1	1-2	1-2	NO	1-2	1-2	1-3	1-3	1-2	1-3	1
0121 - POWER LED	1-2	1-3	1-4	1-2	1-2	1-2	1-6	1-6	2-4	1-6	1
0123 - POWER LED	1-2	1-3	1-4	1-2	1-2	1-2	1-6	1-6	2-4	1-6	1

Solo collegamento in serie - Only serial connection

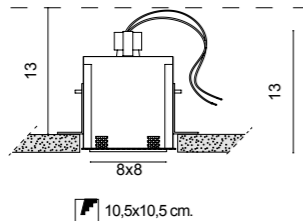

6621 Casper 230V
 .57 Vetro bianco - White glass

Light sources
 7W GU10 LED DIM (cod. 0104/16)
 7W GU10 LED (cod. 0094/16)
 max 50W GU10 (cod. 0072)

0,60 Kg



Glass diffuser

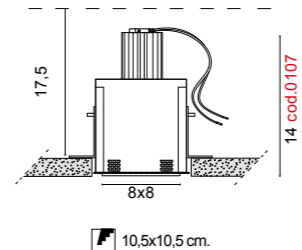

6622 Casper LED
 .57 Vetro bianco - White glass

0,80 Kg



Glass diffuser

6622 + COB LED

Color temperature	Optics	Light sources	lm
0107/CW	5000K /24 /40 /60	COB LED 6,1W 17,3V 350mA	1066lm
0107/W	4000K /24 /40 /60	COB LED 6,1W 17,3V 350mA	975lm
0107/WW	3000K /24 /40 /60	COB LED 6,1W 17,3V 350mA	939lm
0107/XW	2700K /24 /40 /60	COB LED 6,1W 17,3V 350mA	896lm

0108/CW	5000K /24 /40 /60	COB LED 8,9W 17,8V 500mA	1480lm
0108/W	4000K /24 /40 /60	COB LED 8,9W 17,8V 500mA	1353lm
0108/WW	3000K /24 /40 /60	COB LED 8,9W 17,8V 500mA	1303lm
0108/XW	2700K /24 /40 /60	COB LED 8,9W 17,8V 500mA	1244lm

0108/W/IP	4000K /24 /38 /58	COB LED IP44 8,9W 17,8V 500mA	1353lm
0108/WW/IP	3000K /24 /38 /58	COB LED IP44 8,9W 17,8V 500mA	1303lm

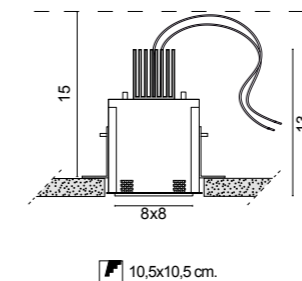

6622 + POWER LED

Color temperature	Optics	Light sources	lm
0121	4000K 25°	POWER LED max 3x3W 700mA	846lm
0123	3000K 25°	POWER LED max 3x3W 700mA	804lm



Glass diffuser



Cod. LED	Drivers ON/OFF				DIMMABLE drivers				DIMMABLE drivers wireless Casambi		LED emergency unit Inverter + Battery + LED indicator
	0125 350mA	0147/COB 500mA	0149/COB 500mA	0126 700mA	0141/DIM PUSH - 1...10V	0141/DALI DIM DALI	0145/DALI DIM DALI	0145 DIM	0718/CASA	0145/CASA	
0107 - COB LED	1	NO	NO	NO	1-2	1-2	1-3	1-3	1-2	1-3	1
0108 - COB LED	1	1-2	1	NO	1-2	1-2	1-3	1-3	1-2	1-3	1
0121 - POWER LED	1-2	1-4	NO	1-2	1-2	1-2	1-6	1-6	2-4	1-6	1
0123 - POWER LED	1-2	1-4	NO	1-2	1-2	1-2	1-6	1-6	2-4	1-6	1

Solo collegamento in serie - Only serial connection

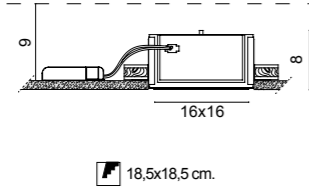

6604 Ghost mini LED
 .01 Bianco - White

Color temperature	Dimming	Light sources	lm
/W 4000K	/DALI	LED 11,9W	1811lm
/W 3000K	/DIM 1...10 PUSH	LED 11,9W	1811lm
/WW 4000K	/DALI	LED 11,9W	1701lm
/WW 3000K	/DIM 1...10 PUSH	LED 11,9W	1701lm

Color temperature	Dimming	Light sources	lm
/W 4000K	/DALI	LED 11,9W	1811lm
/W 3000K	/DIM 1...10 PUSH	LED 11,9W	1811lm
/WW 4000K	/DALI	LED 11,9W	1701lm
/WW 3000K	/DIM 1...10 PUSH	LED 11,9W	1701lm

IP40 1,90 Kg



Methacrylate diffuser



Cod. LED	LED emergency unit
6604	0115/EM Inverter + Battery + LED indicator 1

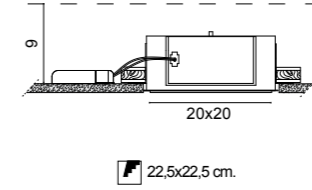

6608 Ghost LED
 .01 Bianco - White

Color temperature	Dimming	Light sources	lm
/W 4000K	/DALI	LED 17,2W	2617lm
/W 3000K	/DIM 1...10 PUSH	LED 17,2W	2452lm
/WW 4000K	/DALI	LED 17,2W	2452lm
/WW 3000K	/DIM 1...10 PUSH	LED 17,2W	2452lm

Color temperature	Dimming	Light sources	lm
/W 4000K	/DALI	LED 17,2W	2617lm
/W 3000K	/DIM 1...10 PUSH	LED 17,2W	2452lm
/WW 4000K	/DALI	LED 17,2W	2452lm
/WW 3000K	/DIM 1...10 PUSH	LED 17,2W	2452lm

IP40 2,40 Kg



Methacrylate diffuser



Cod. LED	LED emergency unit
6608	0115/EM Inverter + Battery + LED indicator 1



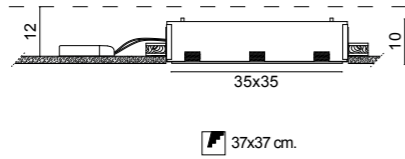

6607 Ghost maxi LED
.01 Bianco - White

Color temperature	Dimming	Light sources	lm
/W 4000K	ON/OFF	LED 28,8W	4400lm
/WW 3000K	ON/OFF	LED 28,8W	3980lm

Color temperature	Dimming	Light sources	lm
/W 4000K	/DALI	LED 28,8W	4400lm
/W 3000K	/DIM 1...10 PUSH	LED 28,8W	4400lm
/WW 4000K	/DALI	LED 28,8W	3980lm
/WW 3000K	/DIM 1...10 PUSH	LED 28,8W	3980lm

IP40 3.70 Kg



Methacrylate diffuser



LED emergency unit

Cod. LED	0115/EM
6607	Inverter + Battery + LED indicator 1

ROTONDO

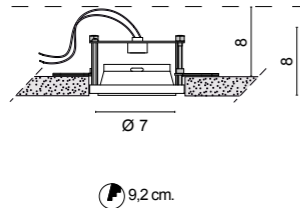

6415 Rotondo
.01 Bianco - White
 Light sources
 12V 50W GU5.3
 0,20 Kg

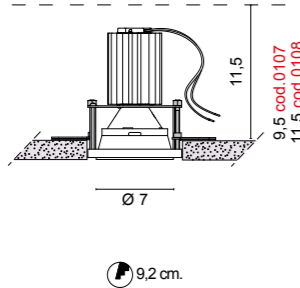

6415 + COB LED

Color temperature	Optics	Light sources	lm
0107/CW 5000K	/24 /40 /60	COB LED 6,1W 17,3V 350mA	1066lm
0107/W 4000K	/24 /40 /60	COB LED 6,1W 17,3V 350mA	975lm
0107/WW 3000K	/24 /40 /60	COB LED 6,1W 17,3V 350mA	939lm
0107/XW 2700K	/24 /40 /60	COB LED 6,1W 17,3V 350mA	896lm
0108/CW 5000K	/24 /40 /60	COB LED 8,9W 17,8V 500mA	1480lm
0108/W 4000K	/24 /40 /60	COB LED 8,9W 17,8V 500mA	1353lm
0108/WW 3000K	/24 /40 /60	COB LED 8,9W 17,8V 500mA	1303lm
0108/XW 2700K	/24 /40 /60	COB LED 8,9W 17,8V 500mA	1244lm
0108/W/IP 4000K	/24 /38 /58	COB LED IP44 8,9W 17,8V 500mA	1353lm
0108/WW/IP 3000K	/24 /38 /58	COB LED IP44 8,9W 17,8V 500mA	1303lm

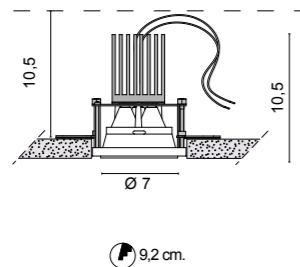

6415 + POWER LED

Color temperature	Optics	Light sources	lm
0121 4000K	25°	POWER LED max 3x3W 700mA	846lm
0123 3000K	25°	POWER LED max 3x3W 700mA	804lm

Accessori - Accessories



0183
 Dischi reggi lampadina in metacrilato
solo per il fissaggio del modulo LED.
 Methacrylate disks
only for fixing LED module.

/TR Trasparente - Clear
/ST Satinato - Satin

Cod. LED	Drivers ON/OFF				DIMMABLE drivers				DIMMABLE drivers wireless Casambi		LED emergency unit
	0125 350mA	0147/COB 500mA	0149/COB 500mA	0126 700mA	0141/DIM PUSH - 1...10V	0141/DALI DIM DALI	0145/DALI DIM DALI	0145 DIM	0718/CASA	0145/CASA	0115/EM Inverter + Battery + LED indicator
0107 - COB LED	1	NO	NO	NO	1-2	1-2	1-3	1-3	1-2	1-3	1
0108 - COB LED	1	1-2	1	NO	1-2	1-2	1-3	1-3	1-2	1-3	1
0121 - POWER LED	1-2	1-4	NO	1-2	1-2	1-2	1-6	1-6	2-4	1-6	1
0123 - POWER LED	1-2	1-4	NO	1-2	1-2	1-2	1-6	1-6	2-4	1-6	1

Solo collegamento in serie - Only serial connection

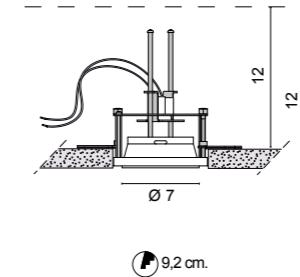

6416 Rotondo 230V
.01 Bianco - White
 Light sources
 7W GU10 LED DIM (cod. 0104/16)
 7W GU10 LED (cod. 0094/16)
 max 50W GU10 (cod. 0072)
 0,30 Kg



6330 + COB LED



6330 + POWER LED



6330 + GU5,3 / GU10

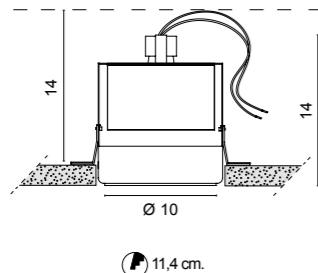

6624 Zero 230V
 .57 Vetro bianco - White glass

Light sources
 7W GU10 LED DIM (cod. 0104/16)
 7W GU10 LED (cod. 0094/16)
 max 50W GU10 (cod. 0072)

0,60 Kg



Glass diffuser

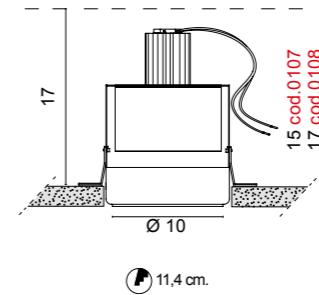
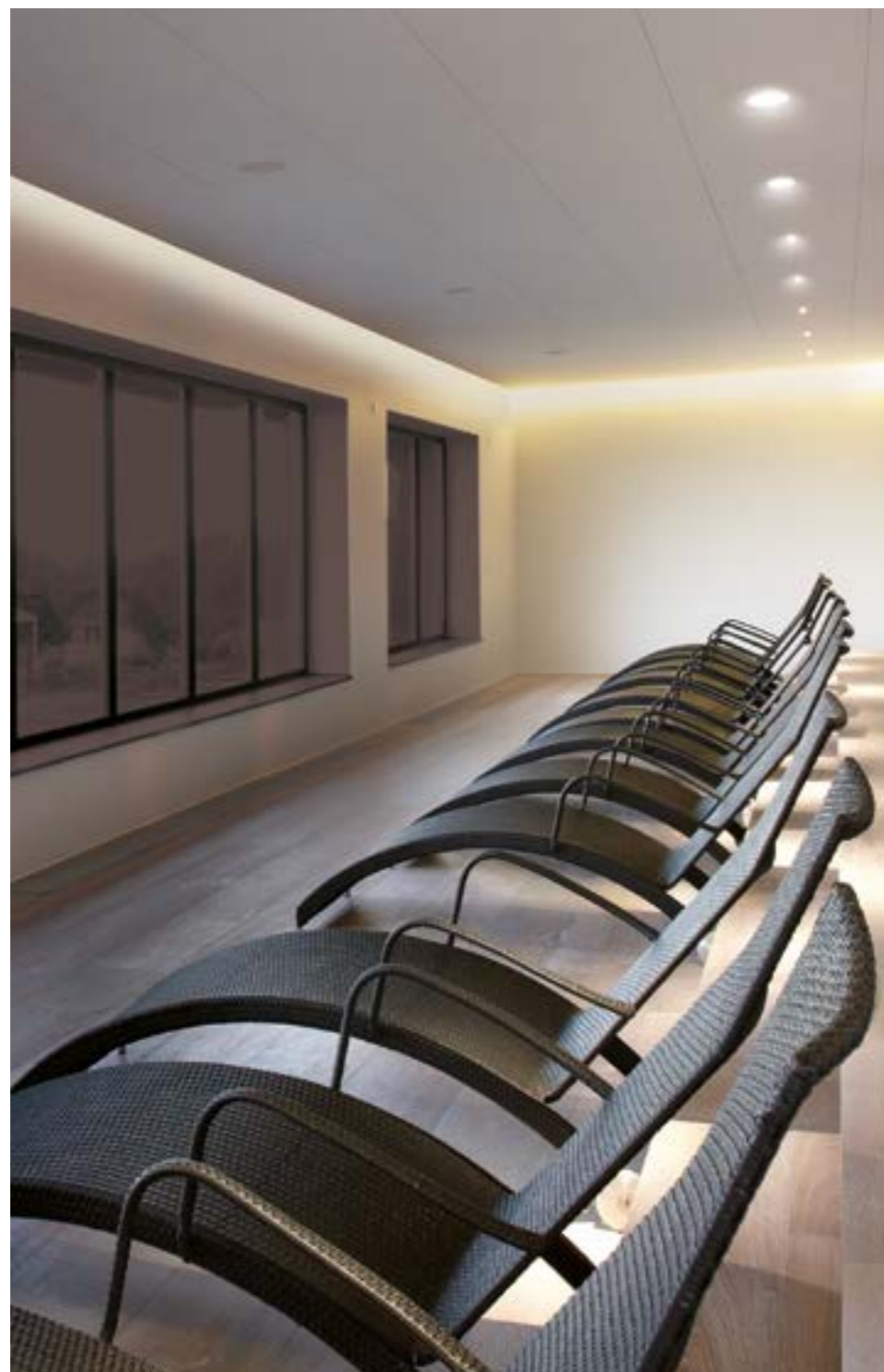

6625 Zero LED
 .57 Vetro bianco - White glass

0,80 Kg



Glass diffuser

6625 + COB LED

Color temperature	Optics	Light sources	lm
0107/CW	5000K /24 /40 /60	COB LED 6,1W 17,3V 350mA	1066lm
0107/W	4000K /24 /40 /60	COB LED 6,1W 17,3V 350mA	975lm
0107/WW	3000K /24 /40 /60	COB LED 6,1W 17,3V 350mA	939lm
0107/XW	2700K /24 /40 /60	COB LED 6,1W 17,3V 350mA	896lm

0108/CW	5000K /24 /40 /60	COB LED 8,9W 17,8V 500mA	1480lm
0108/W	4000K /24 /40 /60	COB LED 8,9W 17,8V 500mA	1353lm
0108/WW	3000K /24 /40 /60	COB LED 8,9W 17,8V 500mA	1303lm
0108/XW	2700K /24 /40 /60	COB LED 8,9W 17,8V 500mA	1244lm

0108/W/IP	4000K /24 /38 /58	COB LED IP44 8,9W 17,8V 500mA	1353lm
0108/WW/IP	3000K /24 /38 /58	COB LED IP44 8,9W 17,8V 500mA	1303lm

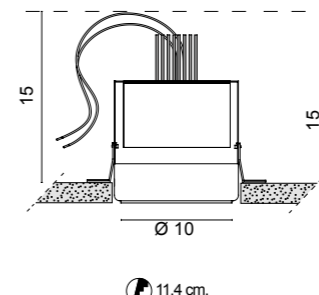

6625 + POWER LED

Color temperature	Optics	Light sources	lm
0121	4000K 25°	POWER LED max 3x3W 700mA	846lm
0123	3000K 25°	POWER LED max 3x3W 700mA	804lm



Glass diffuser

Cod. LED	Drivers ON/OFF				DIMMABLE drivers				DIMMABLE drivers wireless Casambi		LED emergency unit
	0125 350mA	0147/COB 500mA	0149/COB 500mA	0126 700mA	0141/DIM PUSH - 1...10V	0141/DALI DIM DALI	0145/DALI DIM DALI	0145 DIM	0718/CASA	0145/CASA	
0107 - COB LED	1	NO	NO	NO	1-2	1-2	1-3	1-3	1-2	1-3	1
0108 - COB LED	1	1-2	1	NO	1-2	1-2	1-3	1-3	1-2	1-3	1
0121 - POWER LED	1-2	1-4	NO	1-2	1-2	1-2	1-6	1-6	2-4	1-6	1
0123 - POWER LED	1-2	1-4	NO	1-2	1-2	1-2	1-6	1-6	2-4	1-6	1

Solo collegamento in serie - Only serial connection

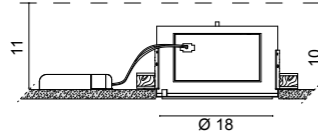

6605 Mirage mini LED
.01 Bianco - White

Color temperature		Light sources		lm
<i>/W</i>	4000K	ON/OFF	LED 11,9W	1811lm
<i>/WW</i>	3000K	ON/OFF	LED 11,9W	1701lm

Color temperature		Dimming	Light sources		lm
<i>/W</i>	4000K	<i>/DALI</i>	LED 11,9W	1811lm	
<i>/W</i>	3000K	<i>/DIM 1...10 PUSH</i>	LED 11,9W	1811lm	
<i>/WW</i>	4000K	<i>/DALI</i>	LED 11,9W	1701lm	
<i>/WW</i>	3000K	<i>/DIM 1...10 PUSH</i>	LED 11,9W	1701lm	

IP40 1,90 Kg

21,5 cm.

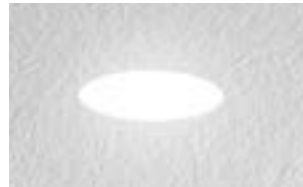

Methacrylate diffuser



Architectural

LED emergency unit

Cod. LED	
0115/EM	Inverter + Battery + LED indicator
6605	1

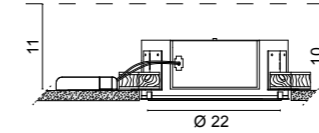

6609 Mirage LED
.01 Bianco - White

Color temperature		Light sources		lm
<i>/W</i>	4000K	ON/OFF	LED 17,2W	2617lm
<i>/WW</i>	3000K	ON/OFF	LED 17,2W	2452lm

Color temperature		Dimming	Light sources		lm
<i>/W</i>	4000K	<i>/DALI</i>	LED 17,2W	2617lm	
<i>/W</i>	3000K	<i>/DIM 1...10 PUSH</i>	LED 17,2W	2452lm	
<i>/WW</i>	4000K	<i>/DALI</i>	LED 17,2W	2452lm	
<i>/WW</i>	3000K	<i>/DIM 1...10 PUSH</i>	LED 17,2W	2452lm	

IP40 2,50 Kg

25,5 cm.



Methacrylate diffuser



Architectural

LED emergency unit

Cod. LED	
0115/EM	Inverter + Battery + LED indicator
6609	1



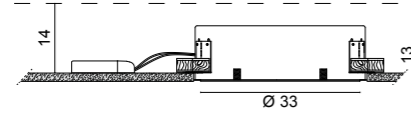

36 cm.

6654 Mirage maxi LED

.01 Bianco - White

Color temperature	Dimming	Light sources	lm
N 4000K	ON/OFF	LED 28,8W	4400lm
NW 3000K	ON/OFF	LED 28,8W	3980lm

Color temperature	Dimming	Light sources	lm
N 4000K	/DALI	LED 28,8W	4400lm
N 3000K	/DIM 1...10 PUSH	LED 28,8W	4400lm
NW 4000K	/DALI	LED 28,8W	3980lm
NW 3000K	/DIM 1...10 PUSH	LED 28,8W	3980lm

F/ IP40

3,50 Kg



Methacrylate diffuser



Cod. LED	LED emergency unit
6654	0115/EM Inverter + Battery + LED indicator 1

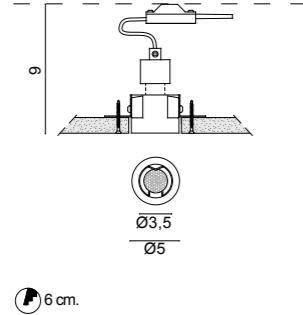

6676 Nihil Tondo mini 230V
.01 Bianco - White
 Light sources
 3W GU10 LED (cod. 0093/19)
 0,07 Kg

Faretti in gesso da incasso per controsoffitti verniciabili, effetto scomparsa totale.
 Trimless recessed plaster spotlights for plaster false ceiling installation.

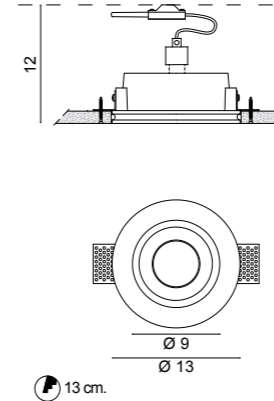

6673 Nihil Tondo 230V
.01 Bianco - White
 Light sources
 7W GU10 LED DIM (cod. 0104/16)
 7W GU10 LED (cod. 0094/16)
 max 50W GU10 (cod. 0072)
 0,50 Kg

Faretti in gesso da incasso per controsoffitti verniciabili, effetto scomparsa totale.
 Trimless recessed plaster spotlights for plaster false ceiling installation.

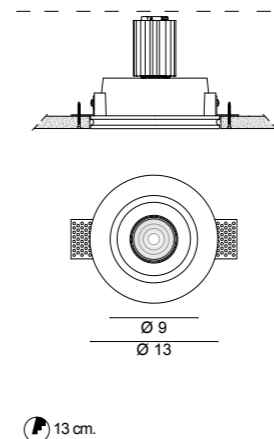

6675 Nihil Tondo LED
.01 Bianco - White
 0,50 Kg

6675 + COB LED

Color temperature	Optics	Light sources	lm
0107/CW 5000K	/24 /40 /60	COB LED 6,1W 17,3V 350mA	1066lm
0107/W 4000K	/24 /40 /60	COB LED 6,1W 17,3V 350mA	975lm
0107/WW 3000K	/24 /40 /60	COB LED 6,1W 17,3V 350mA	939lm
0107/XW 2700K	/24 /40 /60	COB LED 6,1W 17,3V 350mA	896lm
0108/CW 5000K	/24 /40 /60	COB LED 8,9W 17,8V 500mA	1480lm
0108/W 4000K	/24 /40 /60	COB LED 8,9W 17,8V 500mA	1353lm
0108/WW 3000K	/24 /40 /60	COB LED 8,9W 17,8V 500mA	1303lm
0108/XW 2700K	/24 /40 /60	COB LED 8,9W 17,8V 500mA	1244lm
0108/W/IP 4000K	/24 /38 /58	COB LED IP44 8,9W 17,8V 500mA	1353lm
0108/WW/IP 3000K	/24 /38 /58	COB LED IP44 8,9W 17,8V 500mA	1303lm

Faretti in gesso da incasso per controsoffitti verniciabili, effetto scomparsa totale.
 Trimless recessed plaster spotlights for plaster false ceiling installation.

Cod. LED	Drivers ON/OFF			DIMMABLE drivers				DIMMABLE drivers wireless Casambi		LED emergency unit
	0125	0147/COB	0149/COB	0141/DIM	0141/DALI	0145/DALI	0145	0718/CASA	0145/CASA	0115/EM Inverter + Battery + LED indicator
0107 - COB LED	1	NO	NO	1-2	1-2	1-3	1-3	1-2	1-3	1
0108 - COB LED	1	1-2	1	1-2	1-2	1-3	1-3	1-2	1-3	1

Solo collegamento in serie - Only serial connection

NIHIL QUADRO mini 230V

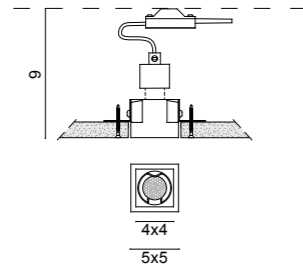

6677 Nihil Quadro mini 230V
.01 Bianco - White
 Light sources
 3W GU10 LED (cod. 0093/19)
 0,07 Kg

6x6 cm.

Faretti in gesso da incasso per controsoffitti verniciabili, effetto scomparsa totale.
 Trimless recessed plaster spotlights for plaster false ceiling installation.

NIHIL QUADRO 230V

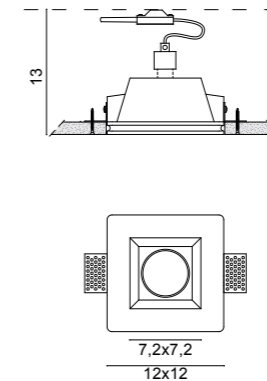

6671 Nihil Quadro 230V
.01 Bianco - White
 Light sources
 7W GU10 LED DIM (cod. 0104/16)
 7W GU10 LED (cod. 0094/16)
 max 50W GU10 (cod. 0072)
 0,50 Kg

12x12 cm.

Faretti in gesso da incasso per controsoffitti verniciabili, effetto scomparsa totale.
 Trimless recessed plaster spotlights for plaster false ceiling installation.



NIHIL QUADRO LED

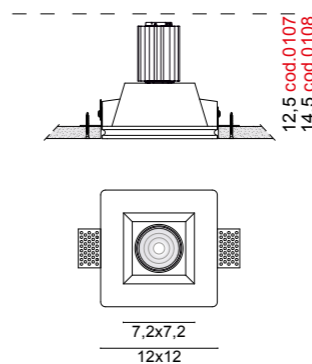

6672 Nihil LED
.01 Bianco - White
 0,50 Kg

6672 + COB LED

Color temperature	Optics	Light sources	lm
0107/CW	5000K /24 /40 /60	COB LED 6,1W 17,3V 350mA	1066lm
0107/W	4000K /24 /40 /60	COB LED 6,1W 17,3V 350mA	975lm
0107/WW	3000K /24 /40 /60	COB LED 6,1W 17,3V 350mA	939lm
0107/XW	2700K /24 /40 /60	COB LED 6,1W 17,3V 350mA	896lm
0108/CW	5000K /24 /40 /60	COB LED 8,9W 17,8V 500mA	1480lm
0108/W	4000K /24 /40 /60	COB LED 8,9W 17,8V 500mA	1353lm
0108/WW	3000K /24 /40 /60	COB LED 8,9W 17,8V 500mA	1303lm
0108/XW	2700K /24 /40 /60	COB LED 8,9W 17,8V 500mA	1244lm
0108/W/IP	4000K /24 /38 /58	COB LED IP44 8,9W 17,8V 500mA	1353lm
0108/WW/IP	3000K /24 /38 /58	COB LED IP44 8,9W 17,8V 500mA	1303lm

12x12 cm.

Faretti in gesso da incasso per controsoffitti verniciabili, effetto scomparsa totale.
 Trimless recessed plaster spotlights for plaster false ceiling installation.

Cod. LED	Drivers ON/OFF			DIMMABLE drivers				DIMMABLE drivers wireless Casambi		LED emergency unit
	0125	0147/COB	0149/COB	0141/DIM	0141/DALI	0145/DALI	0145	0718/CASA	0145/CASA	
	350mA	500mA	500mA	PUSH - 1...10V	DIM DALI	DIM DALI	DIM			Inverter + Battery + LED indicator
0107 - COB LED	1	NO	NO	1-2	1-2	1-3	1-3	1-2	1-3	1
0108 - COB LED	1	1-2	1	1-2	1-2	1-3	1-3	1-2	1-3	1

Solo collegamento in serie - Only serial connection



Systèmes linéaires d'appareils encastrables sans cadre pour installation dans des faux plafonds en placo-plâtre. Profil en alu extrudé verni blanc.

Les systèmes se composent de modules linéaires en plusieurs longueurs (voir tableau) avec circuits LED et convertisseurs inclus.

À commander séparément : embouts terminales en polycarbonate, joints et écran en Méthacrylate satiné.

Deux tonalités de lumière disponibles : 3000K et 4000K, versions dimmables sur demande.

PHANTOM – largeur 4 cm.

Circuits LED qui délivrent nominale-ment 3446 Lm/m (4000K). Angles à 90°, Joints à T et en croix sont livrables comme accessoires.

Sistemas de aparatos LED lineares sin marco para instalacion en falsos techos y paredes de pladur. Perfil de aluminio trefilado pintado blanco.

Los sistemas se componen de modulos lineares de varios largos (véase la tabla) con circuito LED y convertidor incluido.

Se deben pedir por separado: Terminales en policarbonato, enganches y difusor en metacrilato satinado.

Dos temperaturas de color de luz disponibles: 3000K y 4000K, versiones arreglables con dimmer se realizan a pedido.

PHANTOM – 4 cm. de ancho

Utiliza placa de led que entrega 3446 Lm/m nominales (4000K). Accesorios disponibles: perfil angular 90°, perfil a T y a cruz.

Rahmenlose linear LED Einbauleuchten Systemen zur Einsetzung im Zwischendecken und Wände aus Gipskarton. Profil aus matt weiß lackiertem Aluminium.

Die Systemen bestehen aus Modulen in verschiedene Länge(s.Tabelle) komplett mit LED Platine und Konverter.

Separat zu bestellen: Endteile aus Polykarbonat, Verbindungsteile und Diffusor aus satiniertem Methacrylat.

Verfügbar in Zwei Lichtfarben: 3000K und 4000K, dimmbare Ausführungen auf Anfrage.

PHANTOM – Breite 4 cm.

Bestückt mit LED Platine die 3446 Lm/m (4000K) Lichtstrom brutto ergeben. Zubehör: 90° Winkel, T förmige Verbindung oder Kreuz-Verbindung.

Система встраиваемых без окантовки линейных светодиодных светильников, могут устанавливаться в гипсокартонные потолки и стены. Профиль из экструдированного алюминия, окрашенного в белый цвет. Можно объединять в системы светильники различных длин (см. таблицу), блок питания встроенный.

Отдельно заказывается: заглушки из поликарбоната, переходники и рассеиватель из метакрилата. Два варианта цветовой температуры: теплая (3000K) и холодная (4000K), диммируемая версия по запросу.

PHANTOM – ширина 4 см.

Оснащен светодиодным модулем со световым потоком 3446 лм/м (4000K). Доступны соединители: угловые 90°, Т и Х - образные



PHANTOM SYSTEM

design: U.T. EGOLUCE

Sistema di apparecchi LED lineari da incasso a scomparsa totale per installazione in controsoffitti e pareti in cartongesso.

Profilo in estruso di alluminio verniciato bianco. I sistemi si compongono di moduli lineari con lunghezze variabili (vedi tabella) completi di circuiti LED e convertitore.

Da ordinare separatamente: testate di chiusura in policarbonato, giunti e diffusore in metacrilato satinato.

Due tonalità di luce disponibili: 3000K e 4000K; versioni dimmerabili realizzabili a richiesta.

PHANTOM utilizza circuiti LED da 3446 Lm/m nominali (4000K).

Accessori disponibili: giunzioni angolari 90°, a T ed a croce.

Systems of trimless LED linear fixtures to be recessed into plasterboard false ceilings and walls. Extruded aluminum profile, white finish.

Systems are composed of linear fixtures available in different lengths (see table) complete with LED circuits and on-board converter.

To be ordered separately: polycarbonate end pieces, joints and methacrylate diffuser.

Two light tones available: 3000K and 4000K; dimmable options upon request.

PHANTOM – width 4cm.

Is fitted with LED circuits providing nominally 3446 Lm/m (4000K). Corner 90°, T shaped and Cross shaped joints are available as accessories.

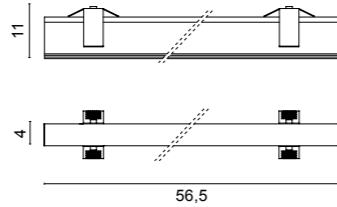

6650 Phantom system

.01 Bianco - White

Color temperature	Light sources	lm
/W 4000K	LED 12,5W	1930lm
/WW 3000K	LED 12,5W	1840lm

IP40 1 Kg

4,7x L cm.

CUSTOM SIZE

Tabella lunghezze disponibili a richiesta. Lunghezza delle lampade senza tappi di chiusura.
Table of available lengths on request. Lamps length without closing heads.

cm.	watt	3000K (WW)	lm	4000K (W)	lm
* 56,5	12,5W	6650.01/WW	1840	6650.01/W	1930
84,5	18,8W	A6650.01/85/WW	2770	A6650.01/85/W	2910
112,5	25W	A6650.01/113/WW	3680	A6650.01/113/W	3860
140,5	31,3W	A6650.01/141/WW	4610	A6650.01/141/W	4840
168,5	37,5W	A6650.01/169/WW	5520	A6650.01/169/W	5790
196,5	43,8W	A6650.01/197/WW	6450	A6650.01/197/W	6770
224,5	50W	A6650.01/225/WW	7360	A6650.01/225/W	7720

* Articolo standard a catalogo - Standard catalogue item

FORO INCASSO - CUT OUT

La lunghezza totale del foro d'incasso si ottiene aggiungendo 1,5 cm alla somma delle lunghezze dei singoli pezzi (vedi schema sotto).
Total length of the cutout is obtained by adding 1,5 cm to the sum of each component length (see scheme below).

Accessori - Accessories



0971
Angolo 90° - 90° corner
.01 Bianco - White

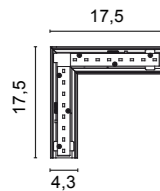

Color temperature	Light sources	lm
/W 4000K	LED 6,3W	930lm
/WW 3000K	LED 6,3W	980lm

IP40 0,70 Kg



0972
Giunzione a T - T joint
.01 Bianco - White

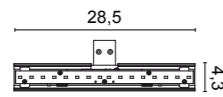

Color temperature	Light sources	lm
/W 4000K	LED 6,3W	930lm
/WW 3000K	LED 6,3W	980lm

IP40 0,70 Kg



0973
Giunzione a croce - Cross joint
.01 Bianco - White

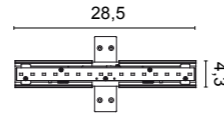

Color temperature	Light sources	lm
/W 4000K	LED 6,3W	930lm
/WW 3000K	LED 6,3W	980lm

IP40 0,70 Kg



0845
Schermo in metacrilato satinato.
Satin methacrylate diffuser.
/100 100cm
/200 200cm
/300 300cm



0290
2 testate di chiusura
2 end stoppers
.01 Bianco - White



0291
Giunto con cavi
Connector with wires
.01 Bianco - White



Lunghezze superiori ai 224,5 cm si ottengono accostando i singoli elementi, il foro d'incasso si calcola con la seguente formula:
Configurations longer than 224,5 cm can be obtained by putting single fittings side by side in a row, the cutout length can be calculated with the formula hereunder:

Esempi - Examples 4,7xL cm.

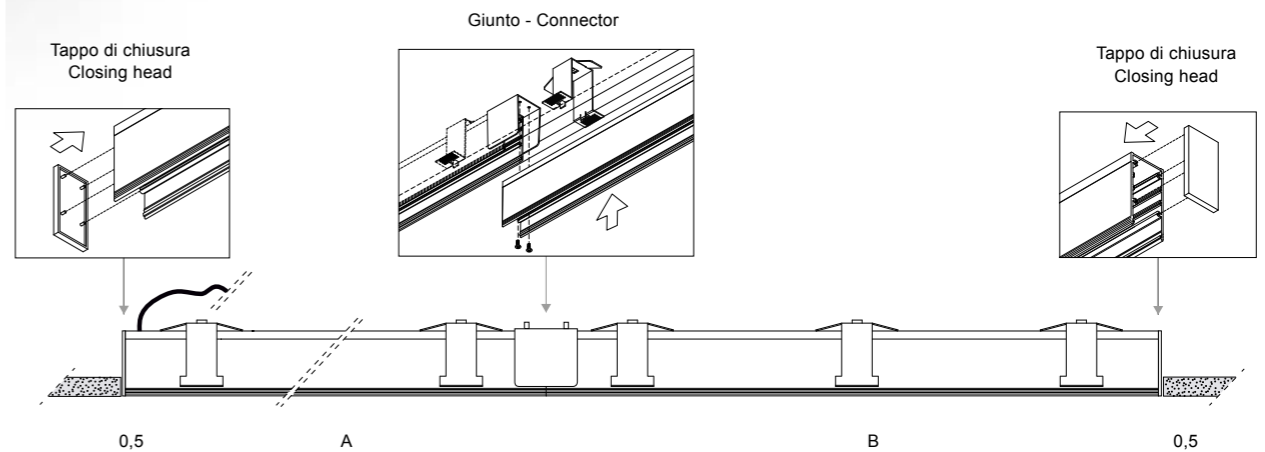

$L = (0,5+A+B+0,5) + 0,5$
A B ... = Lunghezza delle lampade senza tappi di chiusura. Lamps length without closing heads.

Esempio di configurazione - Configuration example

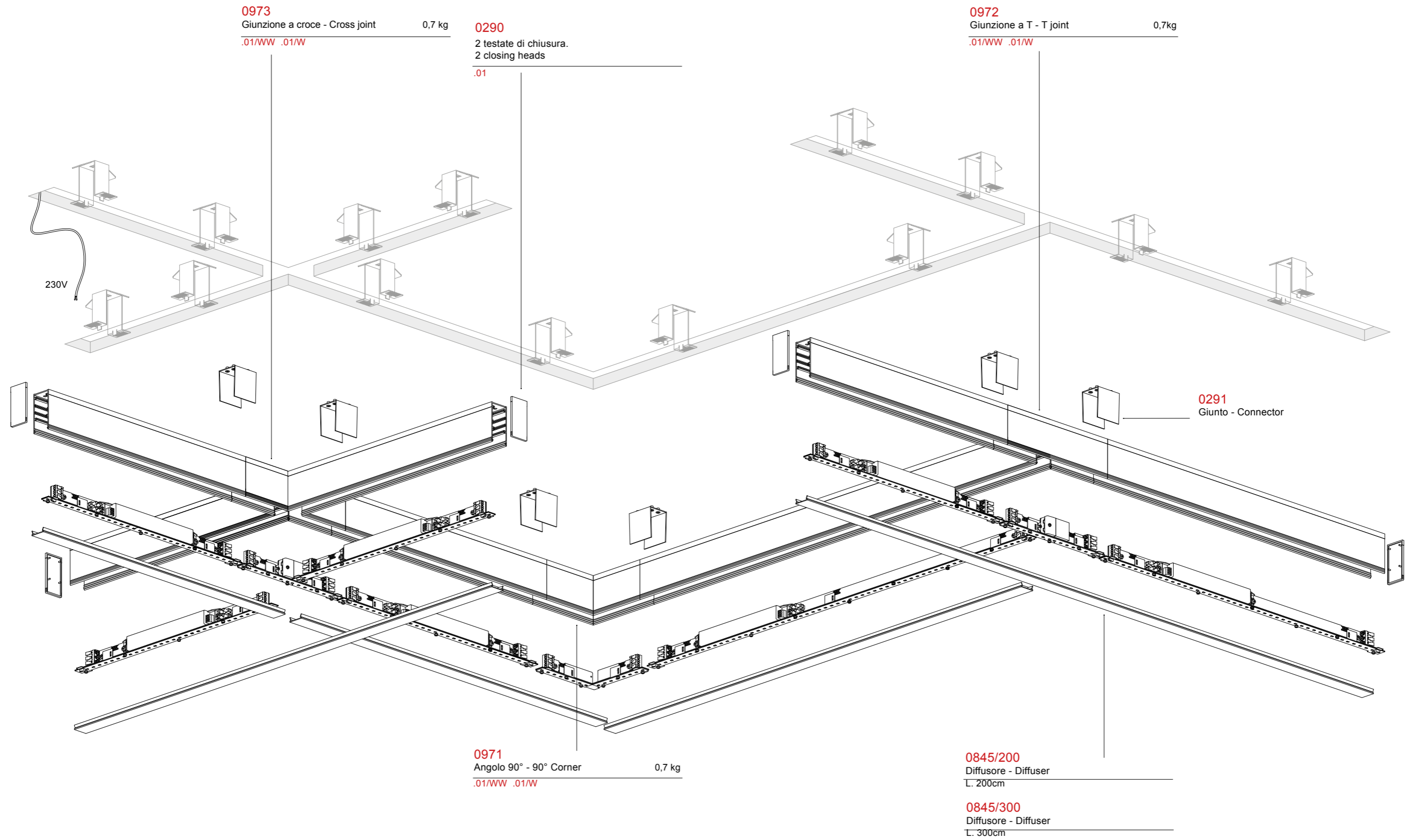

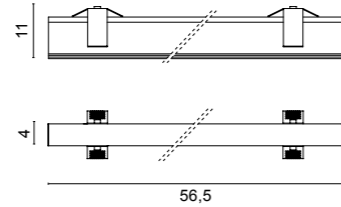

6649 Phantom system DIMM 1..10V
.01 Bianco - White

Color temperature	Light sources	lm
/W 4000K	LED 12,5W	1930lm
/WW 3000K	LED 12,5W	1840lm

IP40 Dim 1 Kg

4,7x L cm.

CUSTOM SIZE

Tabella lunghezze disponibili a richiesta. Lunghezza delle lampade senza tappi di chiusura.
 Table of available lengths on request. Lamps length without closing heads.

cm.	watt	3000K (WW)	lm	4000K (W)	lm
* 56,5	12,5W	6649.01/WW	1840	6649.01/W	1930
84,5	18,8W	A6649.01/85/WW	2770	A6649.01/85/W	2910
112,5	25W	A6649.01/113/WW	3680	A6649.01/113/W	3860
140,5	31,3W	A6649.01/141/WW	4610	A6649.01/141/W	4840
168,5	37,5W	A6649.01/169/WW	5520	A6649.01/169/W	5790
196,5	43,8W	A6649.01/197/WW	6450	A6649.01/197/W	6770
224,5	50W	A6649.01/225/WW	7360	A6649.01/225/W	7720

* Articolo standard a catalogo - Standard catalogue item

FORO INCASSO - CUT OUT

La lunghezza totale del foro d'incasso si ottiene aggiungendo 1,5 cm alla somma delle lunghezze dei singoli pezzi (vedi schema pagina pag. 101).
 Total length of the cutout is obtained by adding 1,5 cm to the sum of each component length (see page 101).

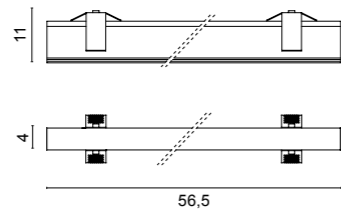

6653 Phantom system DIMM DALI
.01 Bianco - White

Color temperature	Light sources	lm
/W 4000K	LED 12,5W	1930lm
/WW 3000K	LED 12,5W	1840lm

IP40 Dim 1 Kg

4,7x L cm.

CUSTOM SIZE

Tabella lunghezze disponibili a richiesta. Lunghezza delle lampade senza tappi di chiusura.
 Table of available lengths on request. Lamps length without closing heads.

cm.	watt	3000K (WW)	lm	4000K (W)	lm
* 56,5	12,5W	6653.01/WW	1840	6653.01/W	1930
84,5	18,8W	A6653.01/85/WW	2770	A6653.01/85/W	2910
112,5	25W	A6653.01/113/WW	3680	A6653.01/113/W	3860
140,5	31,3W	A6653.01/141/WW	4610	A6653.01/141/W	4840
168,5	37,5W	A6653.01/169/WW	5520	A6653.01/169/W	5790
196,5	43,8W	A6653.01/197/WW	6450	A6653.01/197/W	6770
224,5	50W	A6653.01/225/WW	7360	A6653.01/225/W	7720

* Articolo standard a catalogo - Standard catalogue item

FORO INCASSO - CUT OUT

La lunghezza totale del foro d'incasso si ottiene aggiungendo 1,5 cm alla somma delle lunghezze dei singoli pezzi (vedi schema pagina pag. 101).
 Total length of the cutout is obtained by adding 1,5 cm to the sum of each component length (see page 101).



Phantom System DIMMABLE consente solo installazioni lineari. - Phantom System DIMMABLE allows only linear installations.

Accessori - Accessories



0845
 Schermo in metacrilato satinato.
 Satin methacrylate diffuser.
/100 100cm
/200 200cm
/300 300cm



0290
 2 testate di chiusura
 2 end stoppers
.01 Bianco - White



0291
 Giunto con cavi
 Connector with wires
.01 Bianco - White

	pag.
NEWTON TRACK 48V	110
NEWTON SLIM TRACK 48V	112
NEWTON FLAT TRACK 48V	114
NEWTON TRACK 230V	120
NEWTON SLIM TRACK 230V	122
NEWTON FLAT TRACK 230V	124
NEWTON PLUS TRACK 230V	126
NEWTON EASY TRACK 230V - GU10 129	
NEWTON SPOT	130
NEWTON EASY 230V - GU10	131
NEWTON SLIM SPOT	132
NEWTON FLAT SPOT	133
NEWTON SPOT RECESSED	134
NEWTON SPOT EASY 230V - GU10	135
NEWTON RAIL	136
NEWTON FLAT RAIL	138
NEWTON SLIM RAIL	138

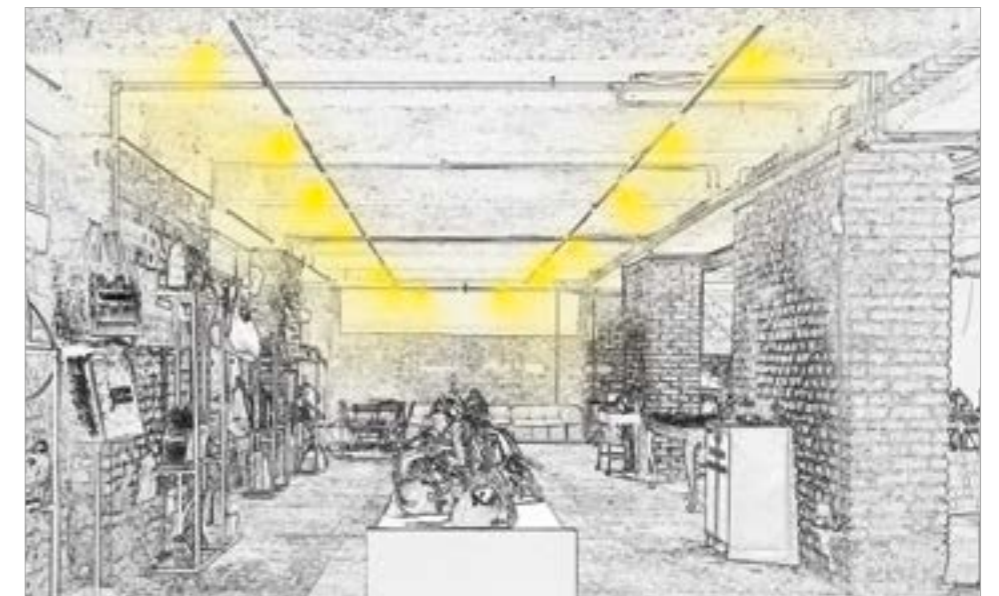
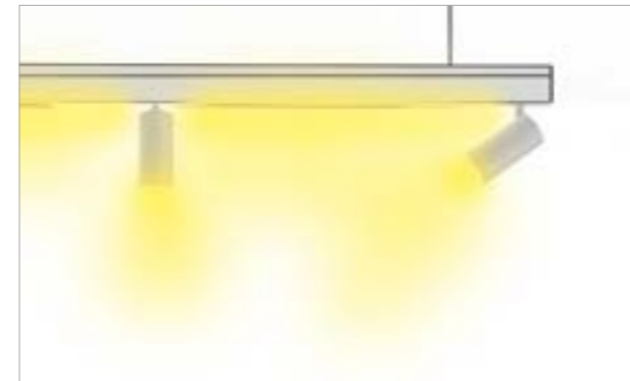
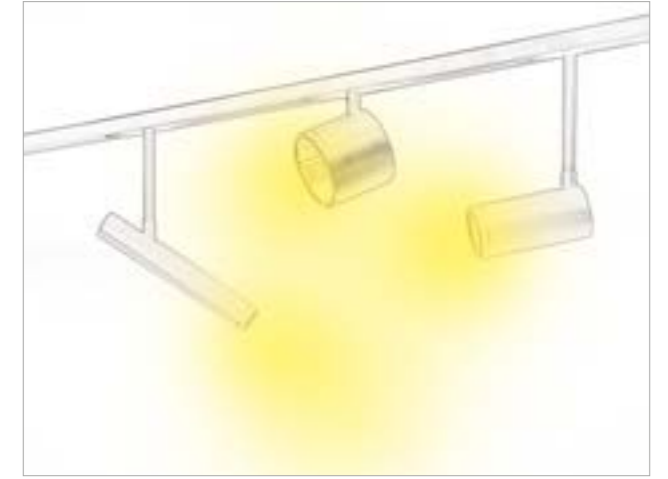



Petits projecteurs avec un design minimal.
Corps en aluminium disponibles en trois modèles différents en diamètres et hauteurs.
Finition: blanc (RAL 9016 opaque), noir (mat RAL 9005) ou, uniquement pour les modèles EASY, or et nickel satiné.

Modèles disponibles:
NEWTON TRACK 48V
NEWTON TRACK 48V RECESSED
NEWTON TRACK 230V
NEWTON SPOT
NEWTON RAIL

Caractéristiques:

- Dissipation passive.
- Inclinaison de 90° sur le plan horizontal.
- Rotation à 350° sur l'axe vertical.
- Différentes optiques disponibles.
- Accessoires décoratifs.
- Accessoires optiques.
- Températures de couleur disponibles: 2700, 3000, 4000K.
- Tiges de différentes longueurs.
- CRI > 90 sur demande.

Kleine Projektoren mit minimalem Design.
Aluminiumgehäuse in drei verschiedenen Modelldurchmessern und -höhen erhältlich.
Oberfläche: weiß lackiert (RAL 9016 opak), schwarz (mat RAL 9005) oder Gold und gebürstetem Nickel (nur für EASY Modelle).

Verfügbare Modelle:
NEWTON TRACK 48V
NEWTON TRACK 48V RECESSED
NEWTON TRACK 230V
NEWTON SPOT
NEWTON RAIL

Eigenschaften:

- Passiver Kühlkörper.
- 90° -Regelung auf horizontaler Ebene.
- 350° Drehung um die vertikale Achse.
- Unterschiedlicher Strahl und Optik Lösungen.
- Dekoratives Zubehör.
- Optikzubehör.
- Verfügbare Lichttöne: 2700, 3000, 4000K
- Unterschiedliche Stablängen.
- CRI > 90 auf Anfrage.

Proyectores de pequeño tamaño con un diseño minimalista.
Cuerpo de aluminio disponible en tres modelos de diferentes diámetros y alturas.
Acabado: blanco (RAL 9016 opak), negro (mate RAL 9005) o, solo para modelos EASY oro y níquel mate.

Tipos disponibles:
NEWTON TRACK 48V
NEWTON TRACK 48V RECESSED
NEWTON TRACK 230V
NEWTON SPOT
NEWTON RAIL

Características:

- Disipación pasiva.
- 90° de inclinación en el plano horizontal.
- 350° de rotación en el eje vertical.
- Diferentes ópticas disponibles.
- Accesorios decorativos.
- Accesorios ópticos.
- Temperaturas de color disponibles: 2700, 3000, 4000K.
- Varillas de diferentes longitudes.
- CRI > 90 bajo pedido.

Небольшие проекторы с минимальным дизайном.
Алюминиевый корпус в наличии в трех разных моделях в диаметры и высоты.
Отделка: белая (RAL 9016 непрозрачная), черный (матовый RAL 9005) или, только для моделей EASY, золото и сатиновый никель.

Доступные модели:
NEWTON TRACK 48V
NEWTON TRACK 48V RECESSED
NEWTON TRACK 230V
NEWTON SPOT
NEWTON RAIL

Характеристики:

- пассивный отвод тепла
- наклон 90 градусов от горизонтали
- вращение на 350 градусов от вертикальной оси
- различные виды оптики
- декоративные аксессуары
- оптические аксессуары
- цветовая температура 2700, 3000, 4000K
- планки разной длины
- CRI > 90 по запросу

NEWTON design: U.T. EGOLUCE

Proiettori di ridotte dimensioni dal design minimale.
Corpo in alluminio disponibile in tre modelli di differenti diametri e altezze.
Finitura: verniciato bianco (RAL 9016 opak), nero (RAL 9005 opak) o, solo per i modelli EASY, oro e nichel spazzolato.

Tipologie disponibili:
NEWTON TRACK 48V
NEWTON TRACK 48V RECESSED
NEWTON TRACK 230V
NEWTON SPOT
NEWTON RAIL

Caratteristiche:

- Dissipazione passiva.
- Inclinazione 90° sul piano orizzontale.
- Rotazione di 350° sull'asse verticale.
- Diferenti ottiche disponibili.
- Accessori decorativi.
- Accessori ottici.
- Temperature di colore disponibili: 2700, 3000, 4000K.
- Aste di diverse lunghezze.
- CRI > 90 a richiesta.

Small projectors with minimal design.
Aluminum body available in three different models diameters and heights.
Finish: white painted (RAL 9016 opak), black (mat RAL 9005) or gold and brushed nickel (only for EASY models).

Available models:
NEWTON TRACK 48V
NEWTON TRACK 48V RECESSED
NEWTON TRACK 230V
NEWTON SPOT
NEWTON RAIL

Features:

- Passive heatsink.
- 90° regulation on horizontal plan.
- 350° rotation on vertical axis.
- Different beam and optics solutions.
- Decorative accessories.
- Optic accessories.
- Available light tones: 2700, 3000, 4000K
- Different rod lengths.
- CRI > 90 upon request.

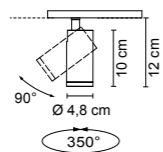
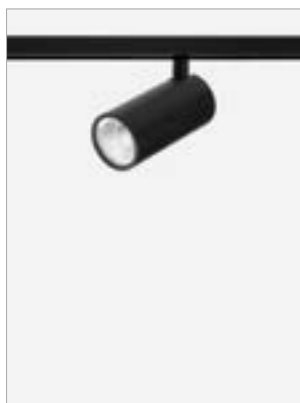

6343 Newton

- .01 Bianco - White
- .02 Nero - Black

Color temperature	Optics	Light sources	lm
<i>N</i> 4000K	<i>/24 /38 /58</i>	LED 48V DC 8,9W	1353lm
<i>N</i> 4000K	<i>/ST</i>	Satinato - Satin	LED 48V DC 8,9W
<i>WW</i> 3000K	<i>/24 /38 /58</i>	LED 48V DC 8,9W	1303lm
<i>WW</i> 3000K	<i>/ST</i>	Satinato - Satin	LED 48V DC 8,9W
<i>XW</i> 2700K	<i>/24 /38 /58</i>	LED 48V DC 8,9W	1244lm
<i>XW</i> 2700K	<i>/ST</i>	Satinato - Satin	LED 48V DC 8,9W

F ⓘ ☒ R 0,40 Kg

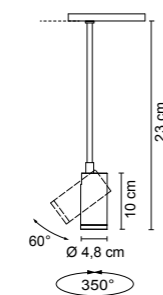

6345 Newton

- .01 Bianco - White
- .02 Nero - Black

Color temperature	Optics	Light sources	lm
<i>N</i> 4000K	<i>/24 /38 /58</i>	LED 48V DC 8,9W	1353lm
<i>N</i> 4000K	<i>/ST</i>	Satinato - Satin	LED 48V DC 8,9W
<i>WW</i> 3000K	<i>/24 /38 /58</i>	LED 48V DC 8,9W	1303lm
<i>WW</i> 3000K	<i>/ST</i>	Satinato - Satin	LED 48V DC 8,9W
<i>XW</i> 2700K	<i>/24 /38 /58</i>	LED 48V DC 8,9W	1244lm
<i>XW</i> 2700K	<i>/ST</i>	Satinato - Satin	LED 48V DC 8,9W

F ⓘ ☒ R 0,50 Kg

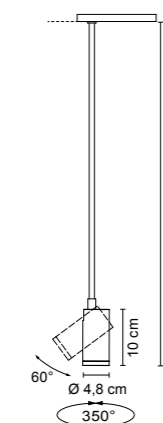

6346 Newton

- .01 Bianco - White
- .02 Nero - Black

Color temperature	Optics	Light sources	lm
<i>N</i> 4000K	<i>/24 /38 /58</i>	LED 48V DC 8,9W	1353lm
<i>N</i> 4000K	<i>/ST</i>	Satinato - Satin	LED 48V DC 8,9W
<i>WW</i> 3000K	<i>/24 /38 /58</i>	LED 48V DC 8,9W	1303lm
<i>WW</i> 3000K	<i>/ST</i>	Satinato - Satin	LED 48V DC 8,9W
<i>XW</i> 2700K	<i>/24 /38 /58</i>	LED 48V DC 8,9W	1244lm
<i>XW</i> 2700K	<i>/ST</i>	Satinato - Satin	LED 48V DC 8,9W

F ⓘ ☒ R 0,60 Kg

Ottiche Disponibili - Available Optics



- /24** Ottica fascio stretto per luce d'accento
Narrow beam optic for accent lighting
- /38** Ottica fascio medio
Medium beam optic
- /58** Ottica fascio largo
Wide beam optic
- /ST** Ottica fascio diffuso per illuminazione generale
Diffused light optic for general lighting



Accessori - Accessories



- 0267** Frangiluce
Louvers
.01 Bianco - White
.02 Nero - Black
- 0274** Schermo antiabbagliamento
Anti-glare screen
.01 Bianco - White
.02 Nero - Black

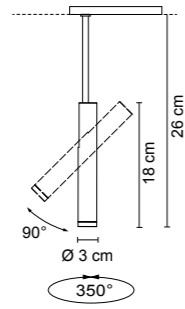

6451 Newton Slim

- .01 Bianco - White
- .02 Nero - Black

Color temperature	Optics	Light sources	lm
<i>N</i> 4000K	<i>/35 /48 /63</i>	LED 48V DC 8,9W	1353lm
<i>N</i> 4000K	<i>/ST</i>	Satinato - Satin	LED 48V DC 8,9W
<i>WW</i> 3000K	<i>/35 /48 /63</i>	LED 48V DC 8,9W	1303lm
<i>WW</i> 3000K	<i>/ST</i>	Satinato - Satin	LED 48V DC 8,9W
<i>XW</i> 2700K	<i>/35 /48 /63</i>	LED 48V DC 8,9W	1244lm
<i>XW</i> 2700K	<i>/ST</i>	Satinato - Satin	LED 48V DC 8,9W



0,50 Kg

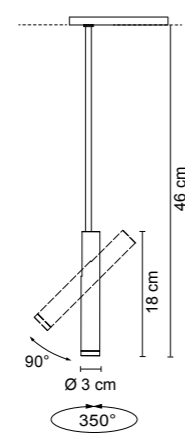

6452 Newton Slim

- .01 Bianco - White
- .02 Nero - Black

Color temperature	Optics	Light sources	lm
<i>N</i> 4000K	<i>/35 /48 /63</i>	LED 48V DC 8,9W	1353lm
<i>N</i> 4000K	<i>/ST</i>	Satinato - Satin	LED 48V DC 8,9W
<i>WW</i> 3000K	<i>/35 /48 /63</i>	LED 48V DC 8,9W	1303lm
<i>WW</i> 3000K	<i>/ST</i>	Satinato - Satin	LED 48V DC 8,9W
<i>XW</i> 2700K	<i>/35 /48 /63</i>	LED 48V DC 8,9W	1244lm
<i>XW</i> 2700K	<i>/ST</i>	Satinato - Satin	LED 48V DC 8,9W



0,60 Kg



Ottiche Disponibili - Available Optics



/35
Ottica fascio stretto per luce d'accento
Narrow beam optic for accent lighting

/48
Ottica fascio medio
Medium beam optic

/63
Ottica fascio largo
Wide beam optic

/ST
Ottica fascio diffuso per illuminazione generale
Diffused light optic for general lighting

Accessori - Accessories



0265
Diffusore in vetro Pyrex sabbaiato
Sand blasted Pyrex glass diffuser
.01 Ghiera bianca - White ferrule
.02 Ghiera nera - Black ferrule

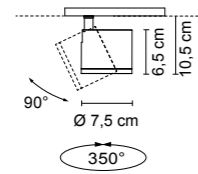
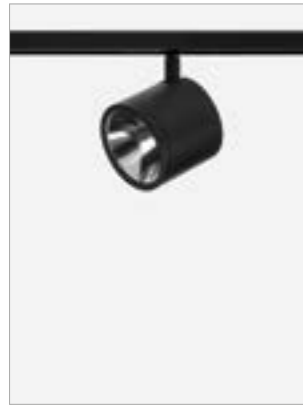

6448 Newton flat

- .01 Bianco - White
- .02 Nero - Black

Color temperature	Optics	Light sources	lm
<i>N</i> 4000K	<i>/13 /40</i>	LED 48V DC 8,9W	1353lm
<i>N</i> 4000K	<i>/ST</i>	Satinato - Satin	LED 48V DC 8,9W 1353lm
<i>MW</i> 3000K	<i>/13 /40</i>	LED 48V DC 8,9W	1303lm
<i>MW</i> 3000K	<i>/ST</i>	Satinato - Satin	LED 48V DC 8,9W 1303lm
<i>XW</i> 2700K	<i>/13 /40</i>	LED 48V DC 8,9W	1244lm
<i>XW</i> 2700K	<i>/ST</i>	Satinato - Satin	LED 48V DC 8,9W 1244lm

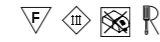

0,50 Kg

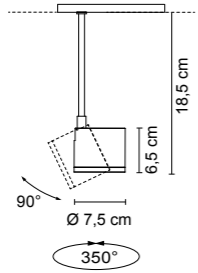

6449 Newton flat

- .01 Bianco - White
- .02 Nero - Black

Color temperature	Optics	Light sources	lm
<i>N</i> 4000K	<i>/13 /40</i>	LED 48V DC 8,9W	1353lm
<i>N</i> 4000K	<i>/ST</i>	Satinato - Satin	LED 48V DC 8,9W 1353lm
<i>MW</i> 3000K	<i>/13 /40</i>	LED 48V DC 8,9W	1303lm
<i>MW</i> 3000K	<i>/ST</i>	Satinato - Satin	LED 48V DC 8,9W 1303lm
<i>XW</i> 2700K	<i>/13 /40</i>	LED 48V DC 8,9W	1244lm
<i>XW</i> 2700K	<i>/ST</i>	Satinato - Satin	LED 48V DC 8,9W 1244lm

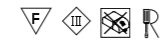

0,60 Kg

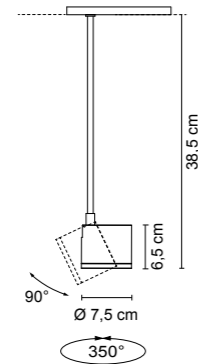

6450 Newton flat

- .01 Bianco - White
- .02 Nero - Black

Color temperature	Optics	Light sources	lm
<i>N</i> 4000K	<i>/13 /40</i>	LED 48V DC 8,9W	1353lm
<i>N</i> 4000K	<i>/ST</i>	Satinato - Satin	LED 48V DC 8,9W 1353lm
<i>MW</i> 3000K	<i>/13 /40</i>	LED 48V DC 8,9W	1303lm
<i>MW</i> 3000K	<i>/ST</i>	Satinato - Satin	LED 48V DC 8,9W 1303lm
<i>XW</i> 2700K	<i>/13 /40</i>	LED 48V DC 8,9W	1244lm
<i>XW</i> 2700K	<i>/ST</i>	Satinato - Satin	LED 48V DC 8,9W 1244lm



0,70 Kg



Accessori - Accessories



0264

Parabola decorativa
Decorative parabolic reflector

- .01 Bianco - White
- .02 Nero - Black



Esempio con 0264 - Example with 0264

Ottiche Disponibili - Available Optics



/13
Ottica fascio stretto per luce d'accento
Narrow beam optic for accent lighting

/40
Ottica fascio largo
Wide beam optic

/ST
Ottica fascio diffuso per illuminazione generale
Diffused light optic for general lighting

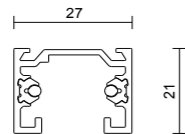

Binari elettrificati a bassa tensione 48V per applicazioni a soffitto, a parete, a sospensione.

I due conduttori per 48V portano, a richiesta, anche il segnale DALI consentendo la regolazione dinamica della luce.

48V low voltage electrified tracks for ceiling, wall, suspensions applications. The two 48V conductors can transmit, upon request, also DALI signal, allowing for the light dynamic control.

7341 Binario 48V (20A) 1mt - Track 48V (20A) 1mt
 .01 Bianco - White
 .02 Nero - Black

7342 Binario 48V (20A) 2mt - Track 48V (20A) 2mt
 .01 Bianco - White
 .02 Nero - Black

7343 Binario 48V (20A) 3mt - Track 48V (20A) 3mt
 .01 Bianco - White
 .02 Nero - Black

Drivers ON/OFF

0160/48

IN: 220 - 240V
 OUT: 48V - 50W
 1-4 Newton

SELV 7 cm.

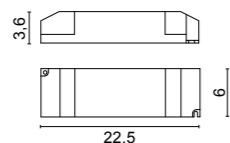

0157/48

IN: 220 - 240V
 OUT: 48V - 70/72W
 1-6 Newton

SELV 7 cm.

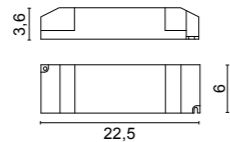

0162/48

IN: 220 - 240V
 OUT: 48V - 150W
 1-12 Newton

SELV 8 cm.

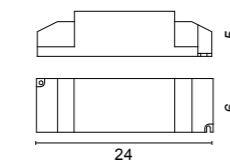

Ceiling rose

0715/48

Rosone con driver
 Ceiling rose with driver
 IN: 220 - 240V
 OUT: 48V - 60W
 ON-OFF
 DIM1...10V
 DIM PUSH
 1-4 Newton

.01 Bianco - White
 .02 Nero - Black

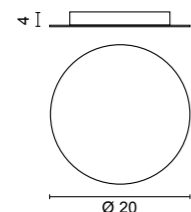

0716/48

Rosone con driver
 Ceiling rose with driver
 IN: 220 - 240V
 OUT: 48V - 60W
 ON-OFF
 1-4 Newton

.01 Bianco - White
 .02 Nero - Black

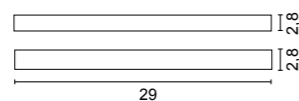

Esempio di configurazione - Configuration example

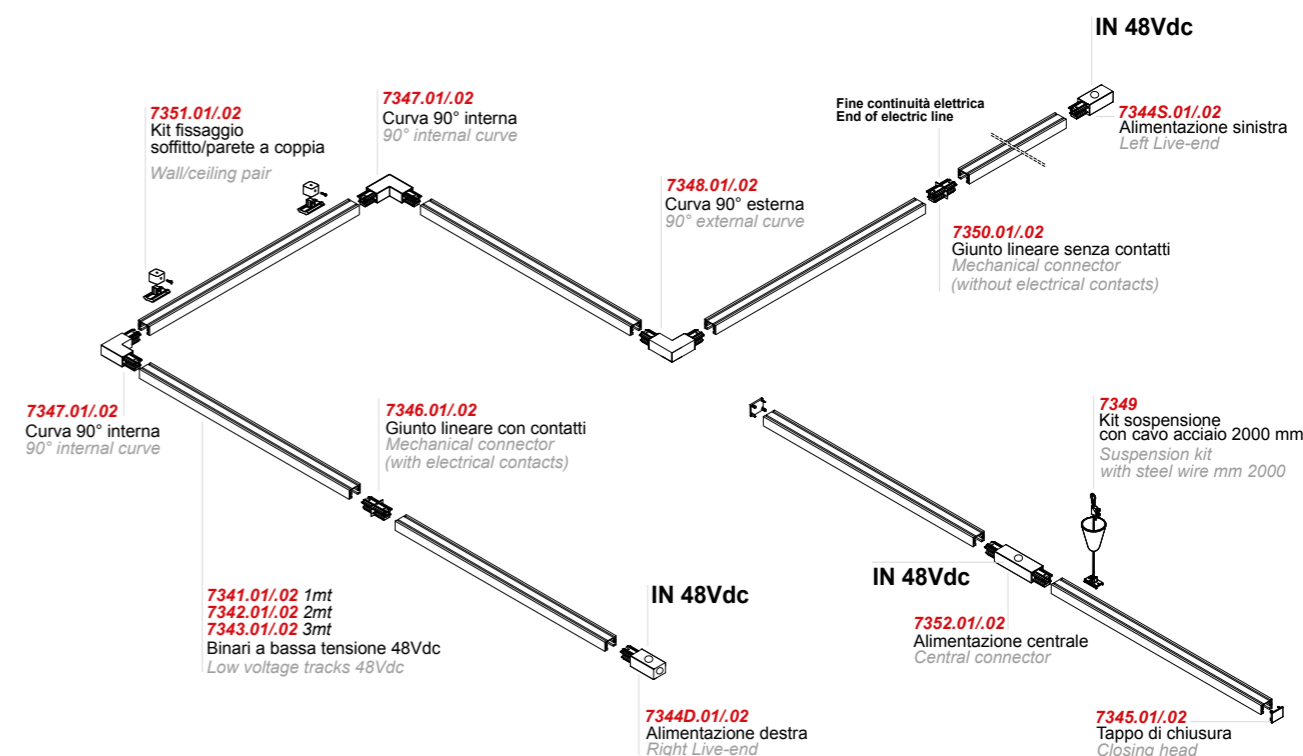

Accessori - Accessories

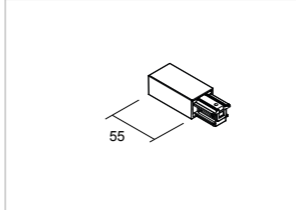
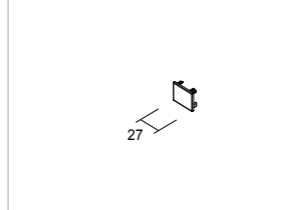
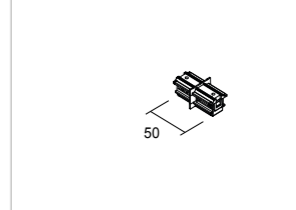
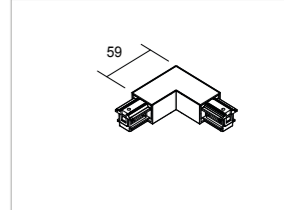
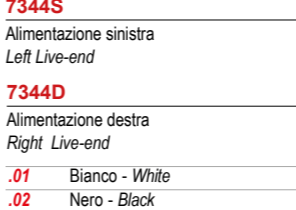
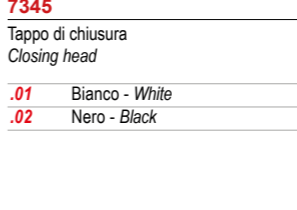
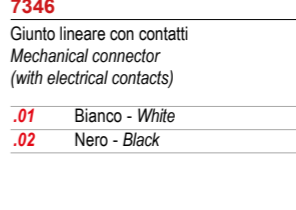
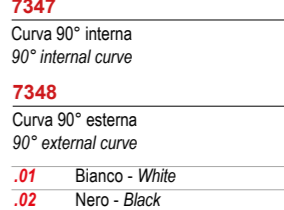
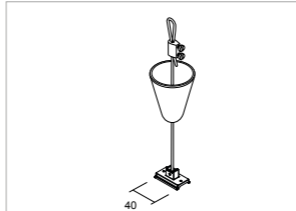
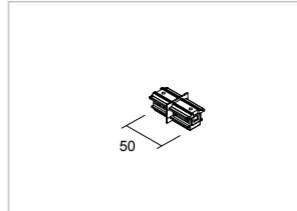
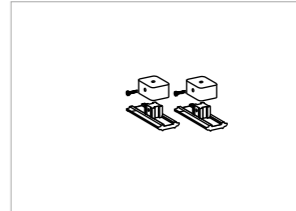
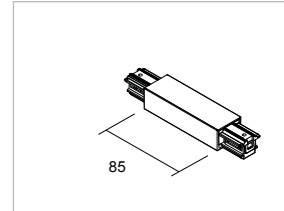
 <p>7344S Alimentazione sinistra Left Live-end</p>	 <p>7345 Tappo di chiusura Closing head</p> <p>.01 Bianco - White .02 Nero - Black</p>	 <p>7346 Giunto lineare con contatti Mechanical connector (with electrical contacts)</p> <p>.01 Bianco - White .02 Nero - Black</p>	 <p>7347 Curva 90° interna 90° internal curve</p>
 <p>7344D Alimentazione destra Right Live-end</p> <p>.01 Bianco - White .02 Nero - Black</p>	 <p>.01 Bianco - White .02 Nero - Black</p>	 <p>.01 Bianco - White .02 Nero - Black</p>	 <p>7348 Curva 90° esterna 90° external curve</p> <p>.01 Bianco - White .02 Nero - Black</p>
 <p>7349 Kit sospensione (cavo 2000mm.) Suspension kit (cable 2000mm.)</p> <p>.01 Bianco - White .02 Nero - Black</p>	 <p>7350 Giunto lineare senza contatti Mechanical connector (without electrical contacts)</p> <p>.01 Bianco - White .02 Nero - Black</p>	 <p>7351 Kit soffitto-parete a coppia Ceiling wall pair</p> <p>.01 Bianco - White .02 Nero - Black</p>	 <p>7352 Alimentazione centrale Central Connector</p> <p>.01 Bianco - White .02 Nero - Black</p>

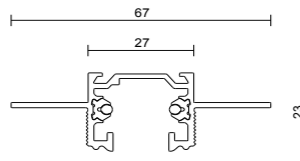

Binari elettrificati a bassa tensione 48V per installazioni a incasso trimless in controsoffitti.
I due conduttori per 48V portano, a richiesta, anche il segnale DALI consentendo la regolazione dinamica della luce.

48V low voltage electrified tracks for trimless recessed installation in false ceilings.
The two 48V conductors can transmit, upon request, also DALI signal, allowing for the light dynamic control.

- 7361** Binario 48V (20A) 1mt - Track 48V (20A) 1mt
.02 Nero - Black
- 7362** Binario 48V (20A) 2mt - Track 48V (20A) 2mt
.02 Nero - Black
- 7363** Binario 48V (20A) 3mt - Track 48V (20A) 3mt
.02 Nero - Black



Esempio di configurazione - Configuration example

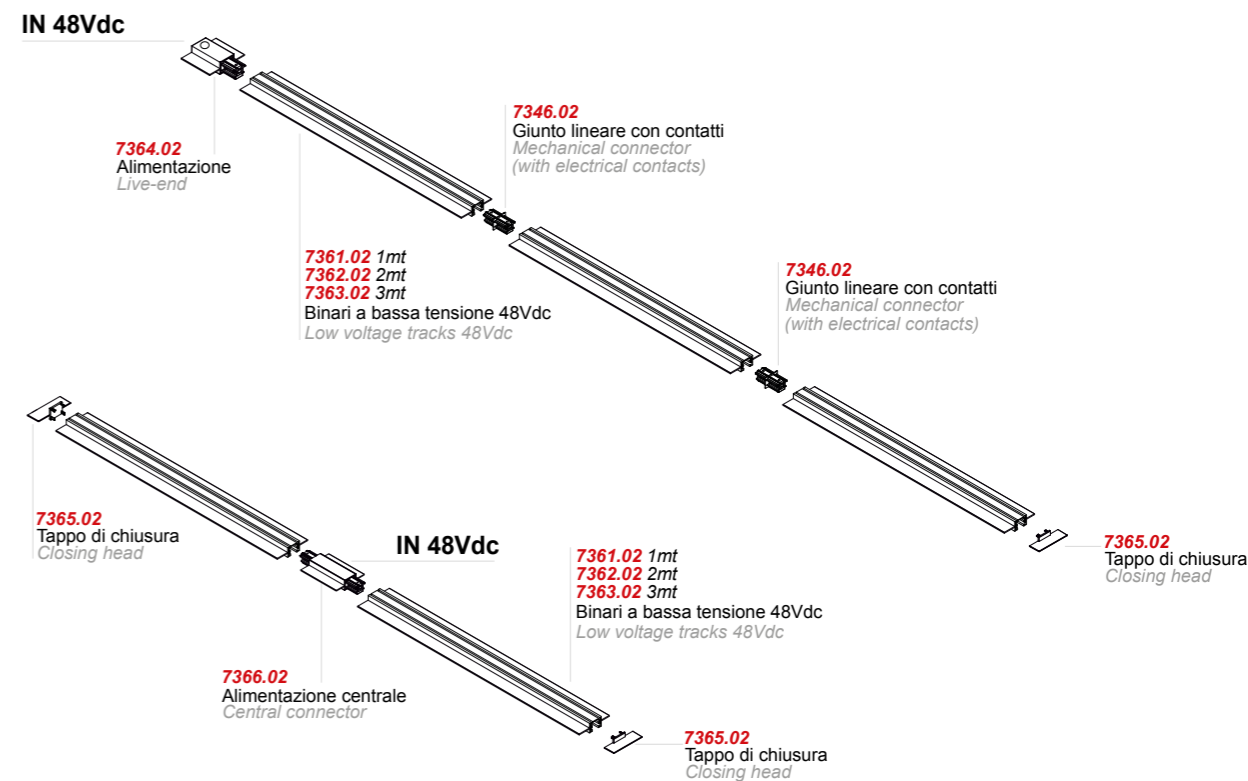

Drivers ON/OFF

0160/48
IN: 220 - 240V
OUT: 48V - 50W
1-4 Newton

SELV 7 cm.

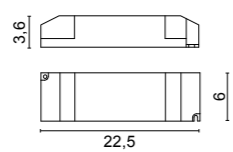

0157/48
IN: 220 - 240V
OUT: 48V - 70/72W
1-6 Newton

SELV 7 cm.

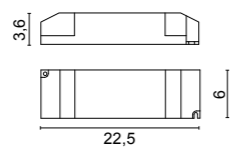

0162/48
IN: 220 - 240V
OUT: 48V - 150W
1-12 Newton

SELV 8 cm.

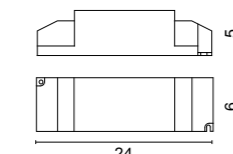

Dimmer 48V

0112/48/DIM
IN: 12/24/48V
OUT: 12/24/48V 6,5A

1...10 V 5 cm.

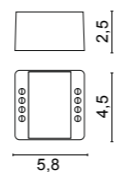

0112/48/DALI
IN: 12/24/48V
OUT: 12/24/48V 6,5A

5 cm.

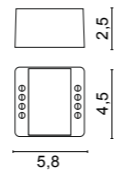

Accessori - Accessories

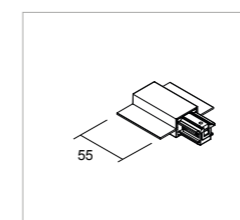

7364
Alimentazione Live-end
.02 Nero - Black

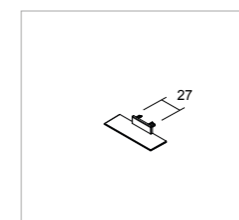

7365
Tappo di chiusura Closing head
.02 Nero - Black

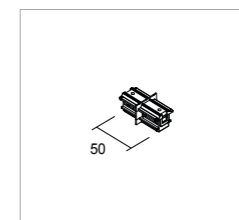

7346
Giunto lineare con contatti Mechanical connector (with electrical contacts)
.01 Bianco - White
.02 Nero - Black

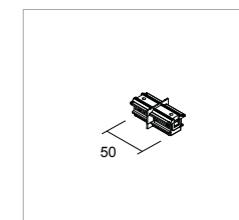

7350
Giunto lineare senza contatti Mechanical connector (without electrical contacts)
.01 Bianco - White
.02 Nero - Black

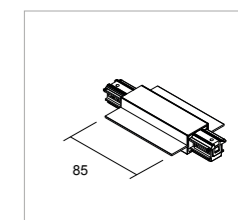

7366
Alimentazione centrale Central Connector
.02 Nero - Black

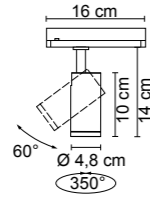

6370 Newton
 .01 Bianco - White
 .02 Nero - Black

Color temperature	Optics	Light sources	lm
<i>N</i> 4000K	<i>/24 /38 /58</i>	LED 8,9W	1353lm
<i>N</i> 4000K	<i>/ST</i>	Satinato - Satin	LED 8,9W
<i>WW</i> 3000K	<i>/24 /38 /58</i>	LED 8,9W	1303lm
<i>WW</i> 3000K	<i>/ST</i>	Satinato - Satin	LED 8,9W
<i>XW</i> 2700K	<i>/24 /38 /58</i>	LED 8,9W	1244lm
<i>XW</i> 2700K	<i>/ST</i>	Satinato - Satin	LED 8,9W

0,55 Kg

A richiesta sono disponibili versioni dimmerabili con controllo **CASAMBI**.
 On request are available dimmable versions with **CASAMBI** control.

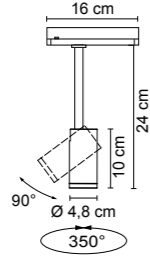

6466 Newton
 .01 Bianco - White
 .02 Nero - Black

Color temperature	Optics	Light sources	lm
<i>N</i> 4000K	<i>/24 /38 /58</i>	LED 8,9W	1353lm
<i>N</i> 4000K	<i>/ST</i>	Satinato - Satin	LED 8,9W
<i>WW</i> 3000K	<i>/24 /38 /58</i>	LED 8,9W	1303lm
<i>WW</i> 3000K	<i>/ST</i>	Satinato - Satin	LED 8,9W
<i>XW</i> 2700K	<i>/24 /38 /58</i>	LED 8,9W	1244lm
<i>XW</i> 2700K	<i>/ST</i>	Satinato - Satin	LED 8,9W

0,65 Kg

A richiesta sono disponibili versioni dimmerabili con controllo **CASAMBI**.
 On request are available dimmable versions with **CASAMBI** control.

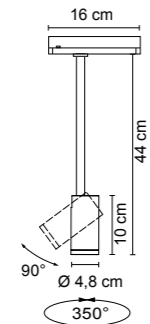

6467 Newton
 .01 Bianco - White
 .02 Nero - Black

Color temperature	Optics	Light sources	lm
<i>N</i> 4000K	<i>/24 /38 /58</i>	LED 8,9W	1353lm
<i>N</i> 4000K	<i>/ST</i>	Satinato - Satin	LED 8,9W
<i>WW</i> 3000K	<i>/24 /38 /58</i>	LED 8,9W	1303lm
<i>WW</i> 3000K	<i>/ST</i>	Satinato - Satin	LED 8,9W
<i>XW</i> 2700K	<i>/24 /38 /58</i>	LED 8,9W	1244lm
<i>XW</i> 2700K	<i>/ST</i>	Satinato - Satin	LED 8,9W

0,75 Kg

A richiesta sono disponibili versioni dimmerabili con controllo **CASAMBI**.
 On request are available dimmable versions with **CASAMBI** control.



Ottiche Disponibili - Available Optics



/24 Ottica fascio stretto per luce d'accento Narrow beam optic for accent lighting	/38 Ottica fascio medio Medium beam optic	/58 Ottica fascio largo Wide beam optic	/ST Ottica fascio diffuso per illuminazione generale Diffused light optic for general lighting
---	--	--	---

Accessori - Accessories



0267
Frangiluce
Louvres
.01 Bianco - White
.02 Nero - Black

0274
Schermo antiabbagliamento
Anti-glare screen
.01 Bianco - White
.02 Nero - Black



Esempio con 0274 - Example with 0274

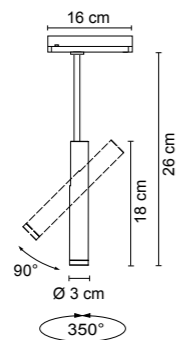

6464 Newton Slim

- .01 Bianco - White
- .02 Nero - Black

Color temperature	Optics	Light sources	lm
<i>N</i> 4000K	<i>/35 /48 /63</i>	LED 8,9W	1353lm
<i>N</i> 4000K	<i>/ST</i>	Satinato - Satin	LED 8,9W
<i>WW</i> 3000K	<i>/35 /48 /63</i>	LED 8,9W	1303lm
<i>WW</i> 3000K	<i>/ST</i>	Satinato - Satin	LED 8,9W
<i>XW</i> 2700K	<i>/35 /48 /63</i>	LED 8,9W	1244lm
<i>XW</i> 2700K	<i>/ST</i>	Satinato - Satin	LED 8,9W

0,50 Kg

A richiesta sono disponibili versioni dimmerabili con controllo **CASAMBI**.
On request are available dimmable versions with **CASAMBI** control.

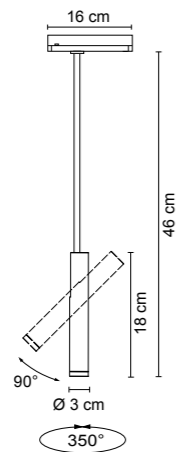

6465 Newton Slim

- .01 Bianco - White
- .02 Nero - Black

Color temperature	Optics	Light sources	lm
<i>N</i> 4000K	<i>/35 /48 /63</i>	LED 8,9W	1353lm
<i>N</i> 4000K	<i>/ST</i>	Satinato - Satin	LED 8,9W
<i>WW</i> 3000K	<i>/35 /48 /63</i>	LED 8,9W	1303lm
<i>WW</i> 3000K	<i>/ST</i>	Satinato - Satin	LED 8,9W
<i>XW</i> 2700K	<i>/35 /48 /63</i>	LED 8,9W	1244lm
<i>XW</i> 2700K	<i>/ST</i>	Satinato - Satin	LED 8,9W

0,60 Kg

A richiesta sono disponibili versioni dimmerabili con controllo **CASAMBI**.
On request are available dimmable versions with **CASAMBI** control.



Esempio con e senza 0265 - Example with or without 0265

Ottiche Disponibili - Available Optics



- /35**
Ottica fascio stretto per luce d'accento
Narrow beam optic for accent lighting
- /48**
Ottica fascio medio
Medium beam optic
- /63**
Ottica fascio largo
Wide beam optic
- /ST**
Ottica fascio diffuso per illuminazione generale
Diffused light optic for general lighting

Accessori - Accessories



- 0265**
Diffusore in vetro Pyrex sabbato
Sand blasted Pyrex glass diffuser
- .01 Ghiera bianca - White ferrule
 - .02 Ghiera nera - Black ferrule

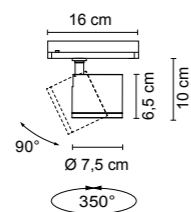
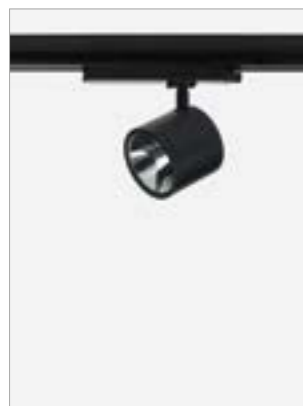

6461 Newton flat

- .01 Bianco - White
- .02 Nero - Black

Color temperature	Optics	Light sources	lm
<i>N</i> 4000K	<i>/13 /40</i>	LED 8,9W	1353lm
<i>N</i> 4000K	<i>/ST</i>	Satinato - Satin	LED 8,9W
<i>WW</i> 3000K	<i>/13 /40</i>	LED 8,9W	1303lm
<i>WW</i> 3000K	<i>/ST</i>	Satinato - Satin	LED 8,9W
<i>XW</i> 2700K	<i>/13 /40</i>	LED 8,9W	1244lm
<i>XW</i> 2700K	<i>/ST</i>	Satinato - Satin	LED 8,9W



0,60 Kg

A richiesta sono disponibili versioni dimmerabili con controllo **CASAMBI**.
On request are available dimmable versions with **CASAMBI** control.

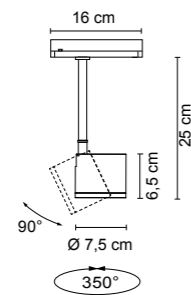

6462 Newton flat

- .01 Bianco - White
- .02 Nero - Black

Color temperature	Optics	Light sources	lm
<i>N</i> 4000K	<i>/13 /40</i>	LED 8,9W	1353lm
<i>N</i> 4000K	<i>/ST</i>	Satinato - Satin	LED 8,9W
<i>WW</i> 3000K	<i>/13 /40</i>	LED 8,9W	1303lm
<i>WW</i> 3000K	<i>/ST</i>	Satinato - Satin	LED 8,9W
<i>XW</i> 2700K	<i>/13 /40</i>	LED 8,9W	1244lm
<i>XW</i> 2700K	<i>/ST</i>	Satinato - Satin	LED 8,9W



0,70 Kg

A richiesta sono disponibili versioni dimmerabili con controllo **CASAMBI**.
On request are available dimmable versions with **CASAMBI** control.

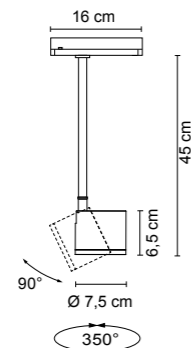

6463 Newton flat

- .01 Bianco - White
- .02 Nero - Black

Color temperature	Optics	Light sources	lm
<i>N</i> 4000K	<i>/13 /40</i>	LED 8,9W	1353lm
<i>N</i> 4000K	<i>/ST</i>	Satinato - Satin	LED 8,9W
<i>WW</i> 3000K	<i>/13 /40</i>	LED 8,9W	1303lm
<i>WW</i> 3000K	<i>/ST</i>	Satinato - Satin	LED 8,9W
<i>XW</i> 2700K	<i>/13 /40</i>	LED 8,9W	1244lm
<i>XW</i> 2700K	<i>/ST</i>	Satinato - Satin	LED 8,9W



0,80 Kg

A richiesta sono disponibili versioni dimmerabili con controllo **CASAMBI**.
On request are available dimmable versions with **CASAMBI** control.

Ottiche Disponibili - Available Optics



/13
Ottica fascio stretto per luce d'accento
Narrow beam optic for accent lighting

/40
Ottica fascio largo
Wide beam optic

/ST
Ottica fascio diffuso per illuminazione generale
Diffused light optic for general lighting



Accessori - Accessories



0264

Parabola decorativa
Decorative parabolic reflector

- .01 Bianco - White
- .02 Nero - Black



Esempio con 0264 - Example with 0264

NEWTON PLUS TRACK 230V

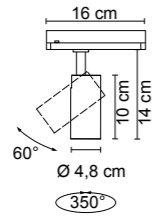

6374 Newton plus

- .01 Bianco - White
- .02 Nero - Black

Color temperature	Optics	Light sources	lm
<i>NW</i> 4000K	/24 /32 /50	LED 17W CRI84	2740lm
<i>NWW</i> 3000K	/24 /32 /50	LED 17W CRI84	2580lm



0,55 Kg

NEWTON EASY TRACK 230V - GU10

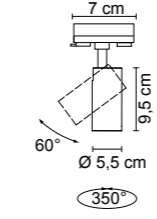

6480 Newton Easy track 230V - GU10

- .01 Bianco - White
- .02 Nero - Black
- .02.25 Snodo nero, corpo dorato satinato - Black articulated joint, satin golded body
- .02.32 Snodo nero, corpo nickel satinato - Black articulated joint, nickel mat body

Light sources

7W GU10 LED (cod. 0094/16)



0,45 Kg



.01 Bianco - White



.02 Nero - Black



.02.25 Corpo dorato satinato
Satin golded body



.02.32 Corpo nickel satinato
Nickel mat body



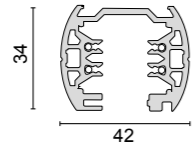

BINARIO elettrificato a tre accensioni diversificate, costruito in lega di alluminio estruso con conduttori in rame alloggiati all'interno di profilati estrusi in PVC.

Electrified TRACK with 3 different switchings, made in extruded aluminium with internal PVC extrusion copper wires.

7321 Binario 250/440V 16A 3mt
 .01 Bianco - White
 .02 Nero - Black

7322 Binario 250/440V 16A 1mt
 .01 Bianco - White
 .02 Nero - Black

7323 Binario 250/440V 16A 2mt
 .01 Bianco - White
 .02 Nero - Black

Esempio di configurazione - Configuration example

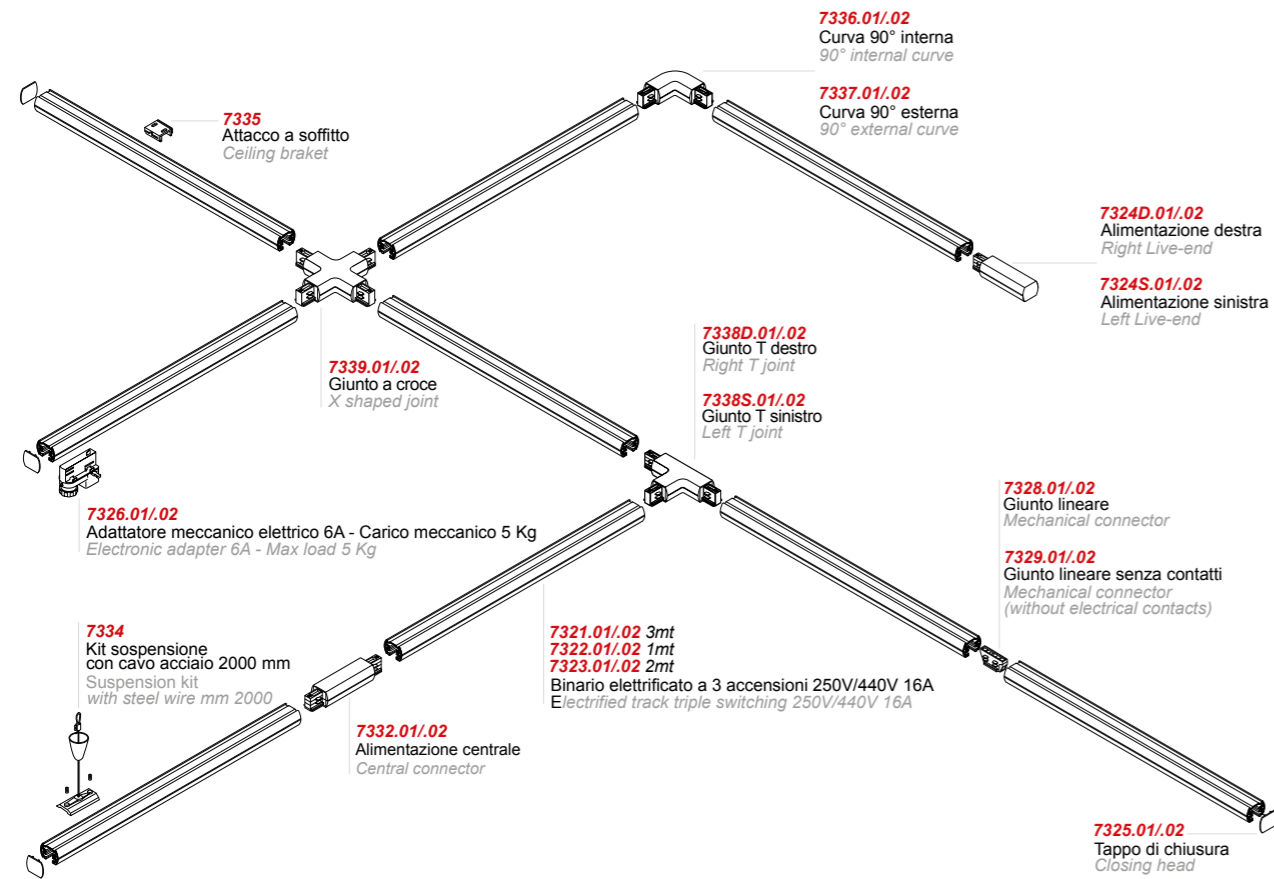

I giunti di collegamento saranno Destro o Sinistro secondo la posizione laterale del contatto di terra.
Joints will be right(D) or left(S) following the lateral position of earth conductors.

Accessori - Accessories



7326
 Adattatore meccanico/elettrico 6A
 Carico meccanico 5 Kg.
*Mechanical/electrical adapters 6A
 Mechanical load 5 Kg.*
 .01 Bianco - White
 .02 Nero - Black



7324S
 Alimentazione sinistra.
Left live-end.

7324D
 Alimentazione destra.
Right live-end.

.01 Bianco - White
 .02 Nero - Black



7325
 Tappo di chiusura
Closing head

.01 Bianco - White
 .02 Nero - Black



7336
 Curva 90° interna
90° internal curve

7337
 Curva 90° esterna
90° external curve

.01 Bianco - White
 .02 Nero - Black



7339
 Giunto X.
X joint.
 .01 Bianco - White
 .02 Nero - Black



7331
 Kit per sospensione binario con
 cavo acciaio (2mt), piastra 12cm.
*Kit to suspend track with
 steel wire (2mt), plate 12cm.*

7334
 Kit per sospensione binario con
 cavo acciaio (2mt), piastra 6cm.
*Kit to suspend track with
 steel wire (2mt), plate 6cm.*
 .01 Bianco - White
 .02 Nero - Black



7328
 Giunto lineare.
Linear joint.

.01 Bianco - White
 .02 Nero - Black



7329
 Giunto lineare senza contatti.
Linear joint without contacts.

.01 Bianco - White
 .02 Nero - Black



7332
 Alimentazione centrale e
 giunto lineare.
*Central connector
 with straight joint.*

.01 Bianco - White
 .02 Nero - Black



7333
 Piastra 12cm.
Plate 12cm.



7338D
 Giunto T destro.
Right T joint.

7338S
 Giunto T sinistro.
Left T joint.

.01 Bianco - White
 .02 Nero - Black



7335
 Attacco soffitto kit.
Ceiling kit.

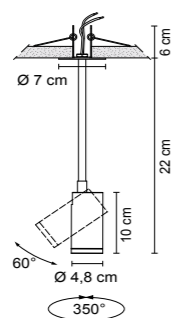

6342 Newton

- .01 Bianco - White
- .02 Nero - Black

Color temperature	Optics	Light sources	lm
<i>N</i> 4000K	<i>/24 /38 /58</i>	LED 8,9W 17,8V 500mA	1353lm
<i>N</i> 4000K	<i>/ST</i>	Satinato - Satin	LED 8,9W 17,8V 500mA 1353lm
<i>WW</i> 3000K	<i>/24 /38 /58</i>	LED 8,9W 17,8V 500mA	1303lm
<i>WW</i> 3000K	<i>/ST</i>	Satinato - Satin	LED 8,9W 17,8V 500mA 1303lm
<i>XW</i> 2700K	<i>/24 /38 /58</i>	LED 8,9W 17,8V 500mA	1244lm
<i>XW</i> 2700K	<i>/ST</i>	Satinato - Satin	LED 8,9W 17,8V 500mA 1244lm



0,55 Kg

5,1 cm.

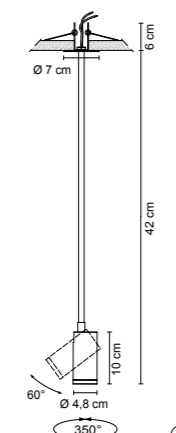

6344 Newton

- .01 Bianco - White
- .02 Nero - Black

Color temperature	Optics	Light sources	lm
<i>N</i> 4000K	<i>/24 /38 /58</i>	LED 8,9W 17,8V 500mA	1353lm
<i>N</i> 4000K	<i>/ST</i>	Satinato - Satin	LED 8,9W 17,8V 500mA 1353lm
<i>WW</i> 3000K	<i>/24 /38 /58</i>	LED 8,9W 17,8V 500mA	1303lm
<i>WW</i> 3000K	<i>/ST</i>	Satinato - Satin	LED 8,9W 17,8V 500mA 1303lm
<i>XW</i> 2700K	<i>/24 /38 /58</i>	LED 8,9W 17,8V 500mA	1244lm
<i>XW</i> 2700K	<i>/ST</i>	Satinato - Satin	LED 8,9W 17,8V 500mA 1244lm



0,65 Kg

5,1 cm.

Accessori - Accessories



0267

Frangilucente
Louvres

- .01 Bianco - White
- .02 Nero - Black

0274

Schermo antiabbagliamento
Anti-glare screen

- .01 Bianco - White
- .02 Nero - Black

Ottiche Disponibili - Available Optics



/24

Ottica fascio stretto per luce d'accento
Narrow beam optic for accent lighting

/38

Ottica fascio medio
Medium beam optic

/58

Ottica fascio largo
Wide beam optic

/ST

Ottica fascio diffuso per illuminazione generale
Diffused light optic for general lighting

Drivers ON/OFF

Cod.	0125	0128	0147/COB	0149/COB
	350mA	350mA	500mA	500mA
6342	1	1-2	1-2	1
6344	1	1-2	1-2	1

DIMMABLE drivers

Cod.	0141/DIM	0141/DALI	0145/DALI	0145
	PUSH - 1...10V	DIM DALI	DIM DALI	DIM
6342	1-2	1-2	1-3	1-3
6344	1-2	1-2	1-3	1-3

DIMMABLE drivers wireless Casambi

Cod.	0718/CASA	0145/CASA
6342	1-2	1-3
6344	1-2	1-3

LED emergency unit

Cod.	0115/EM
	Inverter + Battery + LED indicator
6342	1
6344	1

Solo collegamento in serie - Only serial connection

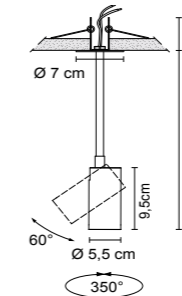

6481 Newton Easy 230

- .01 Bianco - White
- .02 Nero - Black
- .02.25 Snodo nero, corpo dorato satinato - Black articulated joint, satin golded body
- .02.32 Snodo nero, corpo nickel satinato - Black articulated joint, nickel mat body

Light sources

7W GU10 LED (cod. 0094/16)



0,40 Kg

5,1 cm.



.01 Bianco - White



.02 Nero - Black



.02.25 Corpo dorato satinato
Satin golded body



.02.32 Corpo nickel satinato
Nickel mat body

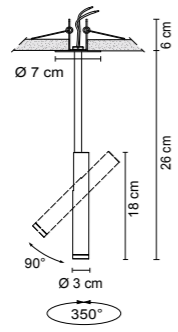

5,1 cm.

6470 Newton Slim

- .01 Bianco - White
- .02 Nero - Black

Color temperature	Optics	Light sources	lm
/W 4000K	/35 /48 /63	LED 8,9W 17,8V 500mA	1353lm
/W 4000K	/ST Satinato - Satin	LED 8,9W 17,8V 500mA	1353lm
/WW 3000K	/35 /48 /63	LED 8,9W 17,8V 500mA	1303lm
/WW 3000K	/ST Satinato - Satin	LED 8,9W 17,8V 500mA	1303lm
/XW 2700K	/35 /48 /63	LED 8,9W 17,8V 500mA	1244lm
/XW 2700K	/ST Satinato - Satin	LED 8,9W 17,8V 500mA	1244lm

F III R 0,50 Kg

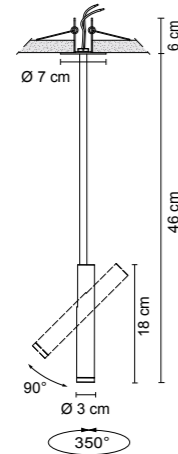

5,1 cm.

6471 Newton Slim

- .01 Bianco - White
- .02 Nero - Black

Color temperature	Optics	Light sources	lm
/W 4000K	/35 /48 /63	LED 8,9W 17,8V 500mA	1353lm
/W 4000K	/ST Satinato - Satin	LED 8,9W 17,8V 500mA	1353lm
/WW 3000K	/35 /48 /63	LED 8,9W 17,8V 500mA	1303lm
/WW 3000K	/ST Satinato - Satin	LED 8,9W 17,8V 500mA	1303lm
/XW 2700K	/35 /48 /63	LED 8,9W 17,8V 500mA	1244lm
/XW 2700K	/ST Satinato - Satin	LED 8,9W 17,8V 500mA	1244lm

F III R 0,60 Kg

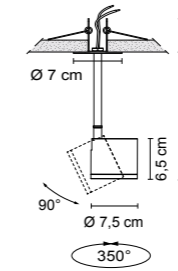
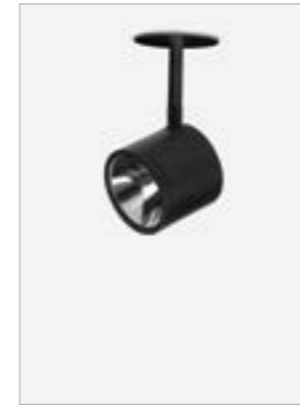

5,1 cm.

6468 Newton flat

- .01 Bianco - White
- .02 Nero - Black

Color temperature	Optics	Light sources	lm
/W 4000K	/13 /40	LED 8,9W 17,8V 500mA	1353lm
/W 4000K	/ST Satinato - Satin	LED 8,9W 17,8V 500mA	1353lm
/WW 3000K	/13 /40	LED 8,9W 17,8V 500mA	1303lm
/WW 3000K	/ST Satinato - Satin	LED 8,9W 17,8V 500mA	1303lm
/XW 2700K	/13 /40	LED 8,9W 17,8V 500mA	1244lm
/XW 2700K	/ST Satinato - Satin	LED 8,9W 17,8V 500mA	1244lm

F III R 0,60 Kg

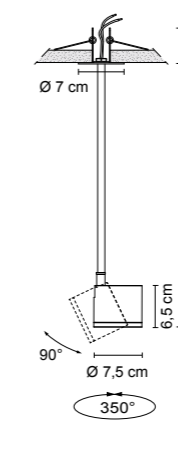

5,1 cm.

6469 Newton flat

- .01 Bianco - White
- .02 Nero - Black

Color temperature	Optics	Light sources	lm
/W 4000K	/13 /40	LED 8,9W 17,8V 500mA	1353lm
/W 4000K	/ST Satinato - Satin	LED 8,9W 17,8V 500mA	1353lm
/WW 3000K	/13 /40	LED 8,9W 17,8V 500mA	1303lm
/WW 3000K	/ST Satinato - Satin	LED 8,9W 17,8V 500mA	1303lm
/XW 2700K	/13 /40	LED 8,9W 17,8V 500mA	1244lm
/XW 2700K	/ST Satinato - Satin	LED 8,9W 17,8V 500mA	1244lm

F III R 0,70 Kg

Accessori - Accessories



0265

Diffusore in vetro Pyrex sabbato
Sand blasted Pyrex glass diffuser

- .01 Ghiera bianca - White ferrule
- .02 Ghiera nera - Black ferrule

Accessori - Accessories



0264

Parabola decorativa
Decorative parabolic reflector

- .01 Bianco - White
- .02 Nero - Black

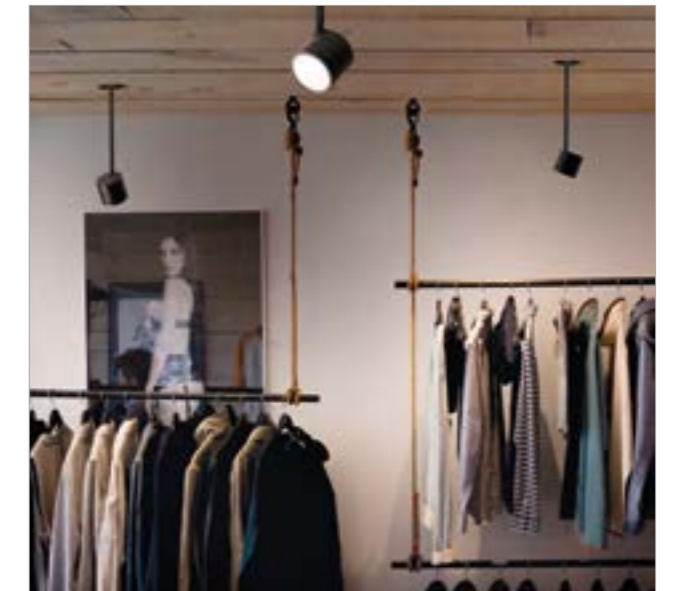

Ottiche Disponibili - Available Optics



- | | | | |
|---|--|--|---|
| /35
Ottica fascio stretto per luce d'accento
Narrow beam optic for accent lighting | /48
Ottica fascio medio
Medium beam optic | /63
Ottica fascio largo
Wide beam optic | /ST
Ottica fascio diffuso per illuminazione generale
Diffused light optic for general lighting |
|---|--|--|---|

Ottiche Disponibili - Available Optics



- | | | |
|---|--|---|
| /13
Ottica fascio stretto per luce d'accento
Narrow beam optic for accent lighting | /40
Ottica fascio largo
Wide beam optic | /ST
Ottica fascio diffuso per illuminazione generale
Diffused light optic for general lighting |
|---|--|---|

Drivers ON/OFF				DIMMABLE drivers				DIMMABLE drivers wireless Casambi		LED emergency unit	
Cod.	0125	0128	0147/COB	0149/COB	0141/DIM	0141/DALI	0145/DALI	0145	0718/CASA	0145/CASA	0115/EM Inverter + Battery + LED indicator
	350mA	350mA	500mA	500mA	PUSH - 1...10V	DIM DALI	DIM DALI	DIM	1-2	1-3	1
6470	1	1-2	1-2	1	1-2	1-2	1-3	1-3	1-2	1-3	1
6471	1	1-2	1-2	1	1-2	1-2	1-3	1-3	1-2	1-3	1

Solo collegamento in serie - Only serial connection

Drivers ON/OFF				DIMMABLE drivers				DIMMABLE drivers wireless Casambi		LED emergency unit	
Cod.	0125	0128	0147/COB	0149/COB	0141/DIM	0141/DALI	0145/DALI	0145	0718/CASA	0145/CASA	0115/EM Inverter + Battery + LED indicator
	350mA	350mA	500mA	500mA	PUSH - 1...10V	DIM DALI	DIM DALI	DIM	1-2	1-3	1
6468	1	1-2	1-2	1	1-2	1-2	1-3	1-3	1-2	1-3	1
6469	1	1-2	1-2	1	1-2	1-2	1-3	1-3	1-2	1-3	1

Solo collegamento in serie - Only serial connection

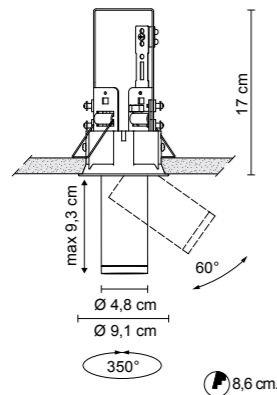

6328 Newton
 .01 Bianco - White
 .02 Nero - Black

Color temperature	Optics	Light sources	lm
<i>/W</i> 4000K	<i>/24 /38 /58</i>	LED 8,9W 17,8V 500mA	1353lm
<i>/W</i> 4000K	<i>/ST</i>	Satinato - Satin	LED 8,9W 17,8V 500mA
<i>/WW</i> 3000K	<i>/24 /38 /58</i>	LED 8,9W 17,8V 500mA	1303lm
<i>/WW</i> 3000K	<i>/ST</i>	Satinato - Satin	LED 8,9W 17,8V 500mA
<i>/XW</i> 2700K	<i>/24 /38 /58</i>	LED 8,9W 17,8V 500mA	1244lm
<i>/XW</i> 2700K	<i>/ST</i>	Satinato - Satin	LED 8,9W 17,8V 500mA

F III R 0,80 Kg



Esempio: /ST - Example: /ST

Accessori - Accessories



0267
 Frangiluce
 Louvres
 .01 Bianco - White
 .02 Nero - Black

0274
 Schermo antiabbagliamento
 Anti-glare screen
 .01 Bianco - White
 .02 Nero - Black

Ottiche Disponibili - Available Optics



/24
 Ottica fascio stretto per luce d'accento
 Narrow beam optic for accent lighting

/38
 Ottica fascio medio
 Medium beam optic

/58
 Ottica fascio largo
 Wide beam optic

/ST
 Ottica fascio diffuso per illuminazione generale
 Diffused light optic for general lighting

Drivers ON/OFF					DIMMABLE drivers				DIMMABLE drivers wireless Casambi		LED emergency unit
Cod.	0125	0128	0147/COB	0149/COB	0141/DIM	0141/DALI	0145/DALI	0145	0718/CASA	0145/CASA	0115/EM
	350mA	350mA	500mA	500mA	PUSH - 1...10V	DIM DALI	DIM DALI	DIM			Inverter + Battery + LED indicator
6328	1	1-2	1-2	1	1-2	1-2	1-3	1-3	1-2	1-3	1

Solo collegamento in serie - Only serial connection



NEWTON SPOT EASY 230V - GU10



6326 Newton Easy 230V - GU10

.01 Bianco - White
 .02 Nero - Black
 .02.25 Snodo nero, corpo dorato satinato - Black articulated joint, satin golded body
 .02.32 Snodo nero, corpo nickel satinato - Black articulated joint, nickel mat body

Light sources
 7W GU10 LED (cod. 0094/16)

0,80 Kg

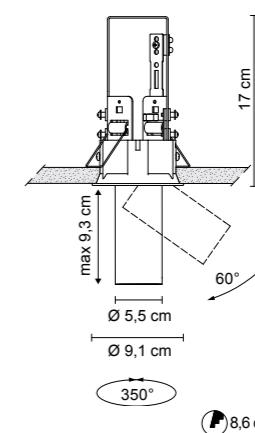

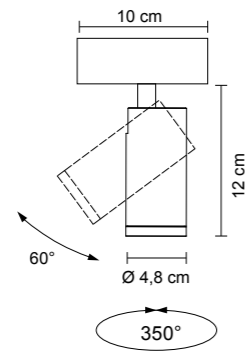

6347 Newton rail

- .01 Bianco - White
- .02 Nero - Black

Color temperature	Optics	Light sources	lm
<i>/W</i> 4000K	<i>/24 /38 /58</i>	LED 8,9W 17,8V 500mA	1353lm
<i>/W</i> 4000K	<i>/ST</i>	Satinato - Satin	LED 8,9W 17,8V 500mA
<i>/WW</i> 3000K	<i>/24 /38 /58</i>	LED 8,9W 17,8V 500mA	1303lm
<i>/WW</i> 3000K	<i>/ST</i>	Satinato - Satin	LED 8,9W 17,8V 500mA
<i>/XW</i> 2700K	<i>/24 /38 /58</i>	LED 8,9W 17,8V 500mA	1244lm
<i>/XW</i> 2700K	<i>/ST</i>	Satinato - Satin	LED 8,9W 17,8V 500mA



0,50 Kg

Il posizionamento e le distanze dei proiettori **NEWTON** nei profili **RAIL** sono da definirsi in fase d'ordine e non possono essere modificati successivamente. Nei sistemi sospensione e plafone i driver sono integrati. Nel sistema incasso sono invece da ordinare separatamente.

The fixing and distances of the **NEWTON** projectors in the **RAIL** profiles are to be defined when ordering and it -cannot be changed later. In suspension and ceiling systems the drivers are integrated. In the recessed system, on the other hand, they must be ordered separately.

6347 Newton Rail +

Rail sospensione - Rail suspension



Driver compresi
Drivers are included

6347 Newton Rail +

Rail plafone - Rail ceiling



Driver compresi
Drivers are included

6347 Newton Rail +

Rail incasso - Rail recessed

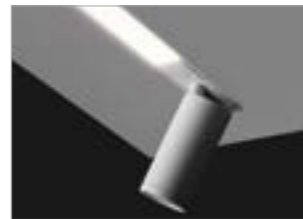

I driver per art. 6347 sono da ordinare separatamente (vedi tabella) pg.137
Drivers for art. 6347 must be ordered separately (see table) pg.137

Accessori - Accessories



0267

Frangilucente
Louvers

- .01 Bianco - White
- .02 Nero - Black

0274

Schermo antiabbagliamento
Anti-glare screen

- .01 Bianco - White
- .02 Nero - Black

Ottiche Disponibili - Available Optics



/24
Ottica fascio stretto per luce d'accento
Narrow beam optic for accent lighting

/38
Ottica fascio medio
Medium beam optic

/58
Ottica fascio largo
Wide beam optic

/ST
Ottica fascio diffuso per illuminazione generale
Diffused light optic for general lighting



Esempio Rail sospensione 1543 + Newton 6347 - I driver sono compresi
Example Rail suspension 1543 + Newton 6347 - Drivers are included

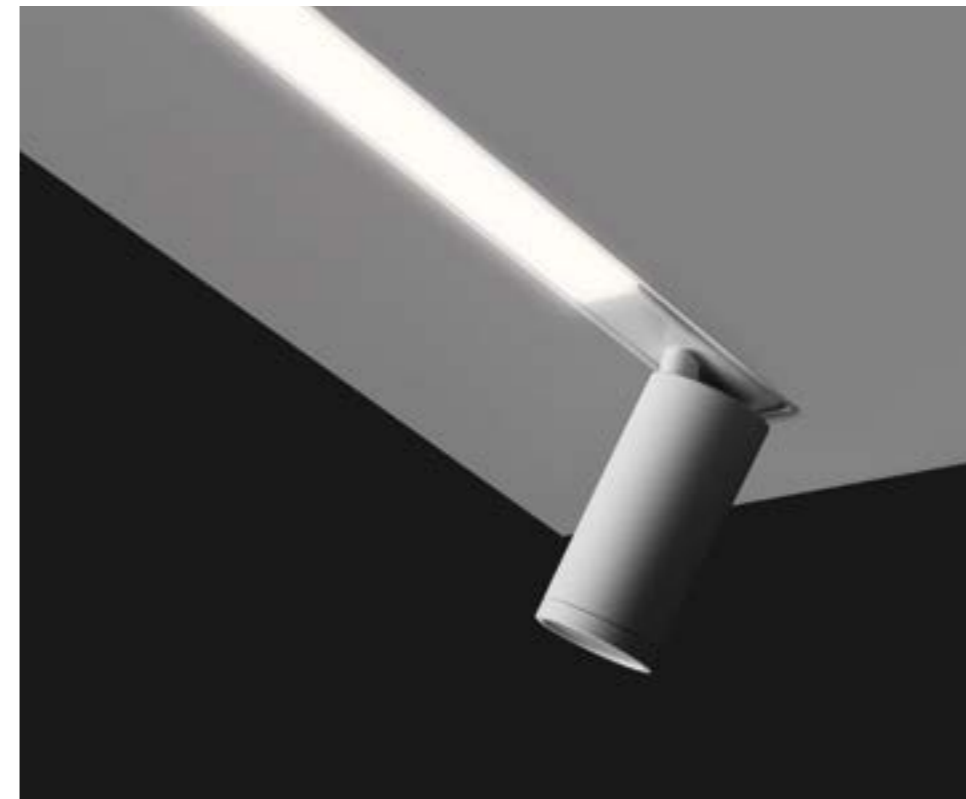

Esempio Rail incasso 6660 + Newton 6347 - I driver sono da ordinare separatamente (vedi tabella)
Example Rail recessed 6660 + Newton 6347 - Drivers must be ordered separately (see table)

Tabella drivers per Newton Rail + Rail incasso - Drivers table for Newton Rail + Rail recessed

Cod.	Drivers ON/OFF				DIMMABLE drivers				DIMMABLE drivers wireless Casambi		LED emergency unit
	0125 350mA	0128 350mA	0147/COB 500mA	0149/COB 500mA	0141/DIM PUSH - 1...10V	0141/DALI DIM DALI	0145/DALI DIM DALI	0145 DIM	0718/CASA	0145/CASA	0115/EM Inverter + Battery + LED indicator
6347	1	1-2	1-2	1	1-2	1-2	1-3	1-3	1-2	1-3	1

Solo collegamento in serie - Only serial connection

NEWTON FLAT RAIL

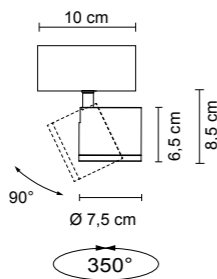

6475 Newton FLAT rail

- .01 Bianco - White
- .02 Nero - Black

Color temperature	Optics	Light sources	lm
<i>W</i> 4000K	<i>/13</i> <i>/40</i>	LED 8,9W 17,8V 500mA	1353lm
<i>W</i> 4000K	<i>/ST</i>	Satinato - Satin LED 8,9W 17,8V 500mA	1353lm
<i>WW</i> 3000K	<i>/13</i> <i>/40</i>	LED 8,9W 17,8V 500mA	1303lm
<i>WW</i> 3000K	<i>/ST</i>	Satinato - Satin LED 8,9W 17,8V 500mA	1303lm
<i>XW</i> 2700K	<i>/13</i> <i>/40</i>	LED 8,9W 17,8V 500mA	1244lm
<i>XW</i> 2700K	<i>/ST</i>	Satinato - Satin LED 8,9W 17,8V 500mA	1244lm



0,55 Kg

Il posizionamento e le distanze dei proiettori **NEWTON** nei profili **RAIL** sono da definirsi in fase d'ordine e non possono essere modificati successivamente. Nei sistemi sospensione e plafone i driver sono integrati. Nel sistema incasso sono invece da ordinare separatamente.

The fixing and distances of the **NEWTON** projectors in the **RAIL** profiles are to be defined when ordering and it -cannot be changed later. In suspension and ceiling systems the drivers are integrated. In the recessed system, on the other hand, they must be ordered separately.

6475 Newton FLAT rail +

Rail sospensione - Rail suspension



Driver compresi
Drivers are included

6475 Newton FLAT rail +

Rail plafone - Rail ceiling



Driver compresi
Drivers are included

6475 Newton FLAT rail +

Rail incasso - Rail recessed



I driver per art. 6475 sono da ordinare separatamente (vedi tabella)
Drivers for art. 6475 must be ordered separately (see table)

Accessori - Accessories



0264

Parabola decorativa
Decorative parabolic reflector

- .01 Bianco - White
- .02 Nero - Black

Ottiche Disponibili - Available Optics



/13

Ottica fascio stretto per luce d'accento
Narrow beam optic for accent lighting

/40

Ottica fascio largo
Wide beam optic

/ST

Ottica fascio diffuso per illuminazione generale
Diffused light optic for general lighting

Tabella drivers per Newton FLAT Rail + Rail incasso - Drivers table for Newton FLAT Rail + Rail recessed

Cod.	Drivers ON/OFF				DIMMABLE drivers				DIMMABLE drivers wireless Casambi		LED emergency unit
	0125 350mA	0128 350mA	0147/COB 500mA	0149/COB 500mA	0141/DIM PUSH - 1...10V	0141/DALI DIM DALI	0145/DALI DIM DALI	0145 DIM	0718/CASA	0145/CASA	0115/EM Inverter + Battery + LED indicator
6475	1	1-2	1-2	1	1-2	1-2	1-3	1-3	1-2	1-3	1

Solo collegamento in serie - Only serial connection

NEWTON SLIM RAIL

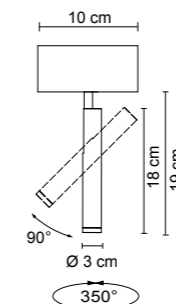

6474 Newton SLIM Rail

- .01 Bianco - White
- .02 Nero - Black

Color temperature	Optics	Light sources	lm
<i>W</i> 4000K	<i>/35</i> <i>/48</i> <i>/63</i>	LED 8,9W 17,8V 500mA	1353lm
<i>W</i> 4000K	<i>/ST</i>	Satinato - Satin LED 8,9W 17,8V 500mA	1353lm
<i>WW</i> 3000K	<i>/35</i> <i>/48</i> <i>/63</i>	LED 8,9W 17,8V 500mA	1303lm
<i>WW</i> 3000K	<i>/ST</i>	Satinato - Satin LED 8,9W 17,8V 500mA	1303lm
<i>XW</i> 2700K	<i>/35</i> <i>/48</i> <i>/63</i>	LED 8,9W 17,8V 500mA	1244lm
<i>XW</i> 2700K	<i>/ST</i>	Satinato - Satin LED 8,9W 17,8V 500mA	1244lm



0,50 Kg

Il posizionamento e le distanze dei proiettori **NEWTON** nei profili **RAIL** sono da definirsi in fase d'ordine e non possono essere modificati successivamente. Nei sistemi sospensione e plafone i driver sono integrati. Nel sistema incasso sono invece da ordinare separatamente.

The fixing and distances of the **NEWTON** projectors in the **RAIL** profiles are to be defined when ordering and it -cannot be changed later. In suspension and ceiling systems the drivers are integrated. In the recessed system, on the other hand, they must be ordered separately.

6474 Newton SLIM rail +

Rail sospensione - Rail suspension



Driver compresi
Drivers are included

6474 Newton SLIM rail +

Rail plafone - Rail ceiling



Driver compresi
Drivers are included

6474 Newton SLIM rail +

Rail incasso - Rail recessed



I driver per art. 6474 sono da ordinare separatamente (vedi tabella)
Drivers for art. 6474 must be ordered separately (see table)

Accessori - Accessories



0265

Diffusore in vetro Pyrex sabbiato
Sand blasted Pyrex glass diffuser

- .01 Ghiera bianca - White ferrule
- .02 Ghiera nera - Black ferrule

Ottiche Disponibili - Available Optics



/35

Ottica fascio stretto per luce d'accento
Narrow beam optic for accent lighting

/48

Ottica fascio medio
Medium beam optic

/63

Ottica fascio largo
Wide beam optic

/ST

Ottica fascio diffuso per illuminazione generale
Diffused light optic for general lighting

Tabella drivers per Newton SLIM Rail + Rail incasso - Drivers table for Newton SLIM Rail + Rail recessed

Cod.	Drivers ON/OFF				DIMMABLE drivers				DIMMABLE drivers wireless Casambi		LED emergency unit
	0125 350mA	0128 350mA	0147/COB 500mA	0149/COB 500mA	0141/DIM PUSH - 1...10V	0141/DALI DIM DALI	0145/DALI DIM DALI	0145 DIM	0718/CASA	0145/CASA	0115/EM Inverter + Battery + LED indicator
6474	1	1-2	1-2	1	1-2	1-2	1-3	1-3	1-2	1-3	1

Solo collegamento in serie - Only serial connection

	pag.
RAIL SYSTEM CEILING/WALL	144
RAIL SYSTEM SUSPENSION	150
RAIL SYSTEM WALL	154
RAIL SYSTEM RECESSED	160
LINEA	166
LINEA RGB	166
LINEA MAXI	170
LINEA MAXI RGB	170
LANCIA CAVO	176
LANCIA TONDA CAVO	178
EXTRA	182
MARGO	184
PLANA	186
MAGIKA	188
INTO	190
WOODY	192
ASTRA	194



Un modo diverso d'interpretare la luce.

Un sistema lineare continuo LED che, allo stesso tempo, diventa uno strumento decorativo per disegnare e ridefinire lo spazio.

La modularità degli elementi permette di realizzare molteplici configurazioni luminose senza ombre o interruzioni.

È possibile disegnare linee, angoli ed incroci di luce su di un unico piano o tra piani diversi (parete/soffitto, parete/sospensione, incasso).

Questo rende RAIL un sistema estremamente versatile che si presta per una vasta gamma di installazioni sia in ambienti privati che pubblici.

A different way to interpret lighting. An endless linear LED lighting system that becomes at the same time a decorative instrument to define and re-design spaces.

The availability of a wide range of modular elements allows to design a number of compositions without any light interruption or shade.

It is possible to draw lines and angles of light on single or multiple planes (Ceiling/wall, wall/suspension, recessed).

This makes RAIL an extremely versatile fixture that fits for a vast range of installations

both in private and public spaces.

Une façon différente d'interpréter la lumière.

Un système linéaire LED qui devient au même temps un instrument décoratif pour dessiner et redéfinir l'espace.

La modularité des éléments permet de réaliser nombreuses configurations lumineuses sans ombres ou interruptions.

On peut dessiner des lignes avec coins et croisements de lumière sur un seul ou plusieurs plans (mur/plafond, mur/suspension, encastré).

Tout ça rend RAIL un appareil extrêmement flexible qui bien s'adapte pour nombreux projets soit dans d'espaces publics ou privés.

RAIL SYSTEM

design: U.T. EGOLUCE

Einen unterschiedliche Interpretation der Licht.

Ein lineares LED Beleuchtungssystem, die gleichzeitig eine dekorative Instrument für Raumdesign ist. Dank die Modularität von verschiedene Elemente, kann man mehrere endlose Kompositionen ohne Schatten oder Unterbrechungen realisieren.

Man kann einfach Lichtlinien mit Winkeln und Kreuzungen zusammensetzen auf eine oder mehrere Oberflächen (Wand/Decke, Wand/Pendel, Einbau).

Auf diesem Grund ist RAIL eine sehr vielseitige Leuchte, die für viele Installationen in Öffentliche- sowie in Privatbereich sehr gut passt.

Una interpretación diferente de la luz

Un sistema linear LED que, al mismo tiempo, se convierte en instrumento decorativo para diseñar y redefinir el espacio.

La modularidad de sus elementos permite de realizar numerosas configuraciones luminosas sin alguna sombra o interrupción.

Se pueden diseñar líneas con esquinas y cruces sur uno o mas planos (techo/pared, pared/suspension, empotrado).

Todo esto hace de RAIL un sistema muy versátiles adapto por varias instalaciones también en espacios públicos y privados.

новый подход к освещению.

Бесконечная линейная светодиодная система, которая может стать одновременно функциональным и декоративным элементом способным изменить дизайн помещения.

Разнообразие элементов для дизайнера световой системы позволяет создавать множество световых композиций избегая темных участков.

Можно создавать световых линии, угловые переходы в одной или нескольких плоскостях (стена/потолок, стена/подвес, встройка).

Это делает RAIL чрезвычайно гибкой системой, которую можно адаптировать как к частным, так и к общественным интерьерам.

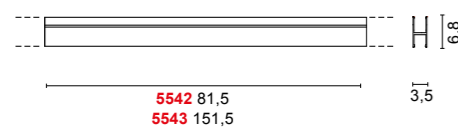

5542 Rail System CEILING/WALL
.01 Bianco - White

Color temperature	Light sources	lm
/W 4000K	LED 14,4W	1808lm
/WW 3000K	LED 14,4W	1616lm
/XW 2700K	LED 14,4W	1512lm

IP40, CRI > 90, 1,1 Kg

5543 Rail System CEILING/WALL
.01 Bianco - White

Color temperature	Light sources	lm
/W 4000K	LED 27W	3390lm
/WW 3000K	LED 27W	3030lm
/XW 2700K	LED 27W	2835lm

IP40, CRI > 90, 1,5 Kg

Nuova versione con circuito 18W/mt., 180 LED/mt. CRI>90.
New version with 18W/mt. strip LED, 180 LED / mt. CRI> 90.

A richiesta sono disponibili altre finiture.
Other finishes upon request.



CUSTOM SIZE

Tabella lunghezze disponibili a richiesta. - Table of available lengths on request.

cm.	watt	2700K (XW)	lm	3000K (WW)	lm	4000K (W)	lm
61,5	10,8W	A5542.01/60/XW	1134	A5542.01/60/WW	1212	A5542.01/60/W	1356
71,5	12,6W	A5542.01/70/XW	1323	A5542.01/70/WW	1414	A5542.01/70/W	1582
* 81,5	14,4W	5542.01/XW	1512	5542.01/WW	1616	5542.01/W	1808
91,5	16,2W	A5542.01/90/XW	1701	A5542.01/90/WW	1818	A5542.01/90/W	2034
101,5	18W	A5542.01/100/XW	1890	A5542.01/100/WW	2020	A5542.01/100/W	2260
111,5	19,8W	A5542.01/110/XW	2079	A5542.01/110/WW	2222	A5542.01/110/W	2486
121,5	21,6W	A5542.01/120/XW	2268	A5542.01/120/WW	2424	A5542.01/120/W	2712
131,5	23,4W	A5542.01/130/XW	2457	A5542.01/130/WW	2626	A5542.01/130/W	2938
141,5	25,2W	A5542.01/140/XW	2646	A5542.01/140/WW	2828	A5542.01/140/W	3164
* 151,5	27W	5543.01/XW	2835	5543.01/WW	3030	5543.01/W	3390
161,5	28,8W	A5542.01/160/XW	3024	A5542.01/160/WW	3232	A5542.01/160/W	3616
171,5	30,6W	A5542.01/170/XW	3213	A5542.01/170/WW	3434	A5542.01/170/W	3842
181,5	32,4W	A5542.01/180/XW	3402	A5542.01/180/WW	3636	A5542.01/180/W	4068
191,5	34,2W	A5542.01/190/XW	3591	A5542.01/190/WW	3838	A5542.01/190/W	4294
201,5	36W	A5542.01/200/XW	3780	A5542.01/200/WW	4040	A5542.01/200/W	4520
211,5	37,8W	A5542.01/210/XW	3969	A5542.01/210/WW	4242	A5542.01/210/W	4746
221,5	39,6W	A5542.01/220/XW	4158	A5542.01/220/WW	4444	A5542.01/220/W	4972
231,5	41,4W	A5542.01/230/XW	4347	A5542.01/230/WW	4646	A5542.01/230/W	5198
241,5	43,2W	A5542.01/240/XW	4536	A5542.01/240/WW	4848	A5542.01/240/W	5424
251,5	45W	A5542.01/250/XW	4725	A5542.01/250/WW	5050	A5542.01/250/W	5650
261,5	46,8W	A5542.01/260/XW	4914	A5542.01/260/WW	5252	A5542.01/260/W	5876
271,5	48,6W	A5542.01/270/XW	5103	A5542.01/270/WW	5454	A5542.01/270/W	6102
281,5	50,4W	A5542.01/280/XW	5292	A5542.01/280/WW	5656	A5542.01/280/W	6328
291,5	52,2W	A5542.01/290/XW	5481	A5542.01/290/WW	5858	A5542.01/290/W	6554
301,5	54W	A5542.01/300/XW	5670	A5542.01/300/WW	6060	A5542.01/300/W	6780

* Articolo standard a catalogo - Standard catalogue item

Accessori - Accessories



0941
Angolo 90° - 90° corner
.01 Bianco - White

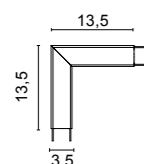

Color temperature	Light sources	lm
/W 4000K	LED 3,6W	452lm
/WW 3000K	LED 3,6W	404lm
/XW 3000K	LED 3,6W	378lm

IP40, CRI > 90, 0,40 Kg



0942
Giunzione a T - T joint
.01 Bianco - White

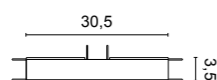

Color temperature	Light sources	lm
/W 4000K	LED 5,4W	678lm
/WW 3000K	LED 5,4W	606lm
/XW 3000K	LED 5,4W	567lm

IP40, CRI > 90, 0,35 Kg



0943
Giunzione a croce - Cross joint
.01 Bianco - White

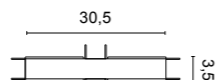

Color temperature	Light sources	lm
/W 4000K	LED 5,4W	678lm
/WW 3000K	LED 5,4W	606lm
/XW 3000K	LED 5,4W	567lm

IP40, CRI > 90, 0,35 Kg



0944
Raccordo parete - plafone
Wall - ceiling joint
.01 Bianco - White

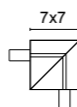

0,15 Kg



0948
Schermo in metacrilato satinato.
Satin methacrylate diffuser.
/100 105cm
/200 205cm
/300 305cm



0945
2 testate di chiusura
2 end stoppers
.01 Bianco - White



Esempio di configurazione - Configuration example

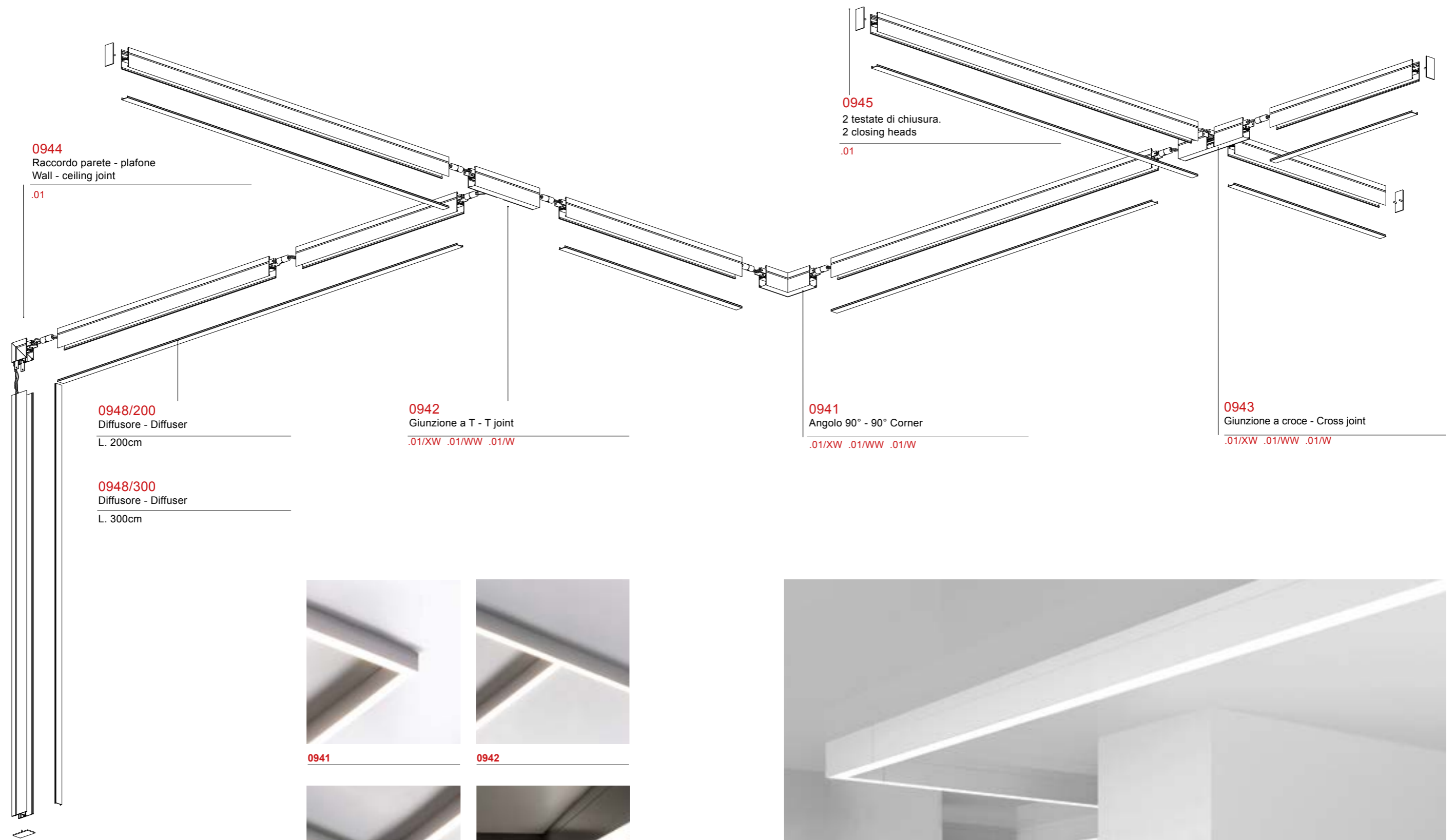

0941



0942



0943



0944





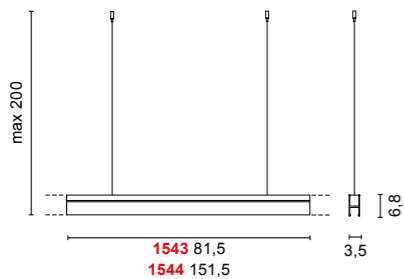

1543 Rail System *SUSPENSION*
 .01 Bianco - *White*

Color temperature	Light sources	lm
/W 4000K	LED 14,4W	1808lm
/WW 3000K	LED 14,4W	1616lm
/XW 2700K	LED 14,4W	1512lm

IP40 CRI>90 R 1 Kg

1544 Rail System *SUSPENSION*
 .01 Bianco - *White*

Color temperature	Light sources	lm
/W 4000K	LED 27W	3390lm
/WW 3000K	LED 27W	3030lm
/XW 2700K	LED 27W	2835lm

IP40 CRI>90 R 1,4 Kg

Nuova versione con circuito 18W/mt., 180 LED/mt. CRI>90.
 New version with 18W/mt. strip LED, 180 LED / mt. CRI> 90.

A richiesta sono disponibili altre finiture.
 Other finishes upon request.



Accessori - *Accessories*



0941
 Angolo 90° - *90° corner*
 .01 Bianco - *White*

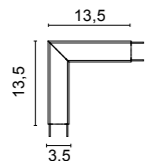

Color temperature	Light sources	lm
/W 4000K	LED 3,6W	452lm
/WW 3000K	LED 3,6W	404lm
/XW 3000K	LED 3,6W	378lm

IP40 CRI>90 0,40 Kg



0942
 Giunzione a T - *T joint*
 .01 Bianco - *White*

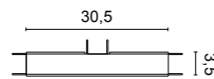

Color temperature	Light sources	lm
/W 4000K	LED 5,4W	678lm
/WW 3000K	LED 5,4W	606lm
/XW 3000K	LED 5,4W	567lm

IP40 CRI>90 0,35 Kg



0943
 Giunzione a croce - *Cross joint*
 .01 Bianco - *White*

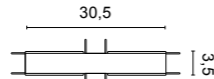

Color temperature	Light sources	lm
/W 4000K	LED 5,4W	678lm
/WW 3000K	LED 5,4W	606lm
/XW 3000K	LED 5,4W	567lm

IP40 CRI>90 0,35 Kg



0944
 Raccordo parete - *plafond*
 Wall - *ceiling joint*
 .01 Bianco - *White*

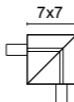

0,15 Kg



0946
 Rosone completo di cavo di alimentazione.
 Ceiling rose with cable.
 .01 Bianco - *White*

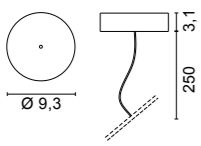

0,07 Kg



0947
 Piastra con molle per controsoffitti
 Ceiling plate with springs
 .01 Bianco - *White*

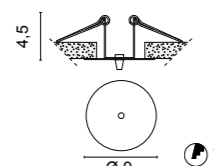

7,5 cm.
 0,08 Kg



0948
 Schermo in metacrilato satinato.
 Satin methacrylate diffuser.
 /100 105cm
 /200 205cm
 /300 305cm



0945
 2 testate di chiusura
 2 end stoppers
 .01 Bianco - *White*

CUSTOM SIZE

Tabella lunghezze disponibili a richiesta. - *Table of available lengths on request.*

cm.	watt	2700K (XW)	lm	3000K (WW)	lm	4000K (W)	lm
61,5	10,8W	A1543.01/60/XW	1134	A1543.01/60/WW	1212	A1543.01/60/W	1356
71,5	12,6W	A1543.01/70/XW	1323	A1543.01/70/WW	1414	A1543.01/70/W	1582
* 81,5	14,4W	1543.01/XW	1512	1543.01/WW	1616	1543.01/W	1808
91,5	16,2W	A1543.01/90/XW	1701	A1543.01/90/WW	1818	A1543.01/90/W	2034
101,5	18W	A1543.01/100/XW	1890	A1543.01/100/WW	2020	A1543.01/100/W	2260
111,5	19,8W	A1543.01/110/XW	2079	A1543.01/110/WW	2222	A1543.01/110/W	2486
121,5	21,6W	A1543.01/120/XW	2268	A1543.01/120/WW	2424	A1543.01/120/W	2712
131,5	23,4W	A1543.01/130/XW	2457	A1543.01/130/WW	2626	A1543.01/130/W	2938
141,5	25,2W	A1543.01/140/XW	2646	A1543.01/140/WW	2828	A1543.01/140/W	3164
* 151,5	27W	1544.01/XW	2835	1544.01/WW	3030	1544.01/W	3390
161,5	28,8W	A1543.01/160/XW	3024	A1543.01/160/WW	3232	A1543.01/160/W	3616
171,5	30,6W	A1543.01/170/XW	3213	A1543.01/170/WW	3434	A1543.01/170/W	3842
181,5	32,4W	A1543.01/180/XW	3402	A1543.01/180/WW	3636	A1543.01/180/W	4068
191,5	34,2W	A1543.01/190/XW	3591	A1543.01/190/WW	3838	A1543.01/190/W	4294
201,5	36W	A1543.01/200/XW	3780	A1543.01/200/WW	4040	A1543.01/200/W	4520
211,5	37,8W	A1543.01/210/XW	3969	A1543.01/210/WW	4242	A1543.01/210/W	4746
221,5	39,6W	A1543.01/220/XW	4158	A1543.01/220/WW	4444	A1543.01/220/W	4972
231,5	41,4W	A1543.01/230/XW	4347	A1543.01/230/WW	4646	A1543.01/230/W	5198
241,5	43,2W	A1543.01/240/XW	4536	A1543.01/240/WW	4848	A1543.01/240/W	5424
251,5	45W	A1543.01/250/XW	4725	A1543.01/250/WW	5050	A1543.01/250/W	5650
261,5	46,8W	A1543.01/260/XW	4914	A1543.01/260/WW	5252	A1543.01/260/W	5876
271,5	48,6W	A1543.01/270/XW	5103	A1543.01/270/WW	5454	A1543.01/270/W	6102
281,5	50,4W	A1543.01/280/XW	5292	A1543.01/280/WW	5656	A1543.01/280/W	6328
291,5	52,2W	A1543.01/290/XW	5481	A1543.01/290/WW	5858	A1543.01/290/W	6554
301,5	54W	A1543.01/300/XW	5670	A1543.01/300/WW	6060	A1543.01/300/W	6780

* Articolo standard a catalogo - *Standard catalogue item*



Esempio di configurazione - *Configuration example*

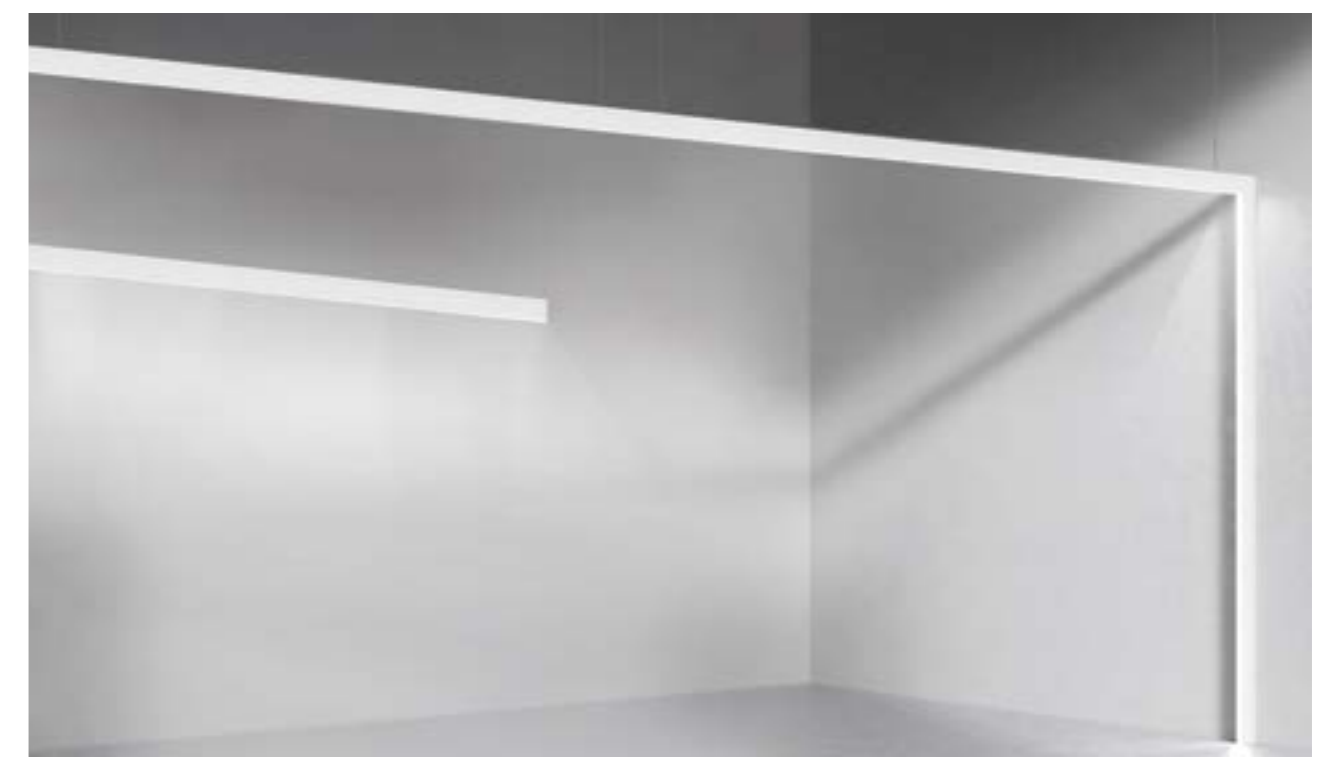
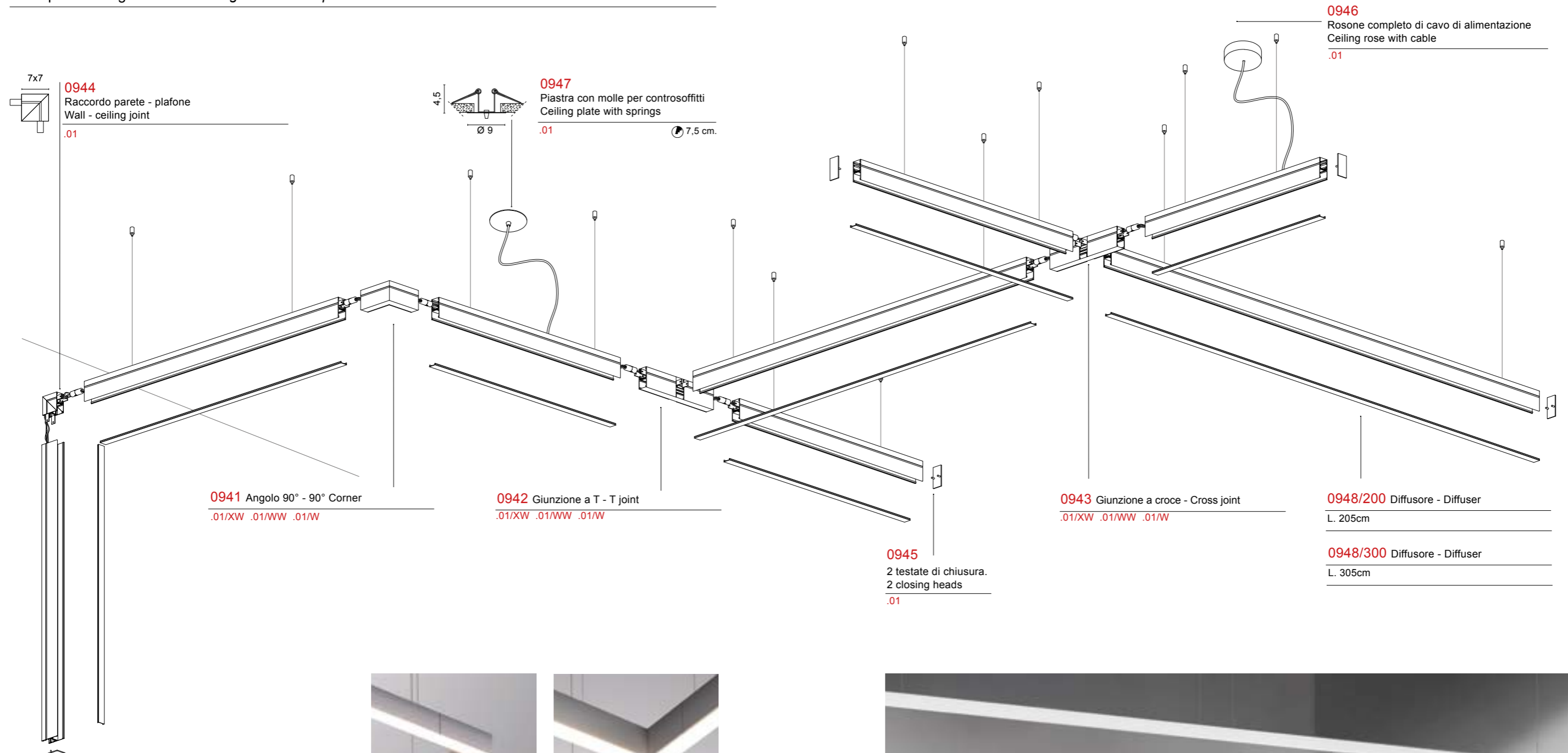

Lighting system

Lighting system

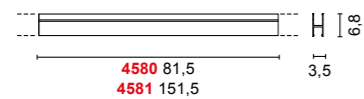

4580 Rail System WALL

.01 Bianco - White

Color temperature	Light sources	lm
/W 4000K	LED 12W	1808lm
/WW 3000K	LED 12W	1616lm
/XW 2700K	LED 12W	1512lm



4581 Rail System WALL

.01 Bianco - White

Color temperature	Light sources	lm
/W 4000K	LED 22,5W	3390lm
/WW 3000K	LED 22,5W	3030lm
/XW 2700K	LED 22,5W	2835lm



Nuova versione con circuito 18W/mt., 180 LED/mt. CRI>90.
New version with 18W/mt. strip LED, 180 LED / mt. CRI> 90.

A richiesta sono disponibili altre finiture.
Other finishes upon request.



CUSTOM SIZE

Tabella lunghezze disponibili a richiesta. - Table of available lengths on request.

cm.	watt	2700K (XW)	lm	3000K (WW)	lm	4000K (W)	lm
61,5	10,8W	A4580.01/60/XW	1134	A4580.01/60/WW	1212	A4580.01/60/W	1356
71,5	12,6W	A4580.01/70/XW	1323	A4580.01/70/WW	1414	A4580.01/70/W	1582
* 81,5	14,4W	4580.01/XW	1512	4580.01/WW	1616	4580.01/W	1808
91,5	16,2W	A4580.01/90/XW	1701	A4580.01/90/WW	1818	A4580.01/90/W	2034
101,5	18W	A4580.01/100/XW	1890	A4580.01/100/WW	2020	A4580.01/100/W	2260
111,5	19,8W	A4580.01/110/XW	2079	A4580.01/110/WW	2222	A4580.01/110/W	2486
121,5	21,6W	A4580.01/120/XW	2268	A4580.01/120/WW	2424	A4580.01/120/W	2712
131,5	23,4W	A4580.01/130/XW	2457	A4580.01/130/WW	2626	A4580.01/130/W	2938
141,5	25,2W	A4580.01/140/XW	2646	A4580.01/140/WW	2828	A4580.01/140/W	3164
* 151,5	27W	4581.01/XW	2835	4581.01/WW	3030	4581.01/W	3390
161,5	28,8W	A4580.01/160/XW	3024	A4580.01/160/WW	3232	A4580.01/160/W	3616
171,5	30,6W	A4580.01/170/XW	3213	A4580.01/170/WW	3434	A4580.01/170/W	3842
181,5	32,4W	A4580.01/180/XW	3402	A4580.01/180/WW	3636	A4580.01/180/W	4068
191,5	34,2W	A4580.01/190/XW	3591	A4580.01/190/WW	3838	A4580.01/190/W	4294
201,5	36W	A4580.01/200/XW	3780	A4580.01/200/WW	4040	A4580.01/200/W	4520
211,5	37,8W	A4580.01/210/XW	3969	A4580.01/210/WW	4242	A4580.01/210/W	4746
221,5	39,6W	A4580.01/220/XW	4158	A4580.01/220/WW	4444	A4580.01/220/W	4972
231,5	41,4W	A4580.01/230/XW	4347	A4580.01/230/WW	4646	A4580.01/230/W	5198
241,5	43,2W	A4580.01/240/XW	4536	A4580.01/240/WW	4848	A4580.01/240/W	5424
251,5	45W	A4580.01/250/XW	4725	A4580.01/250/WW	5050	A4580.01/250/W	5650
261,5	46,8W	A4580.01/260/XW	4914	A4580.01/260/WW	5252	A4580.01/260/W	5876
271,5	48,6W	A4580.01/270/XW	5103	A4580.01/270/WW	5454	A4580.01/270/W	6102
281,5	50,4W	A4580.01/280/XW	5292	A4580.01/280/WW	5656	A4580.01/280/W	6328
291,5	52,2W	A4580.01/290/XW	5481	A4580.01/290/WW	5858	A4580.01/290/W	6554
301,5	54W	A4580.01/300/XW	5670	A4580.01/300/WW	6060	A4580.01/300/W	6780

* Articolo standard a catalogo - Standard catalogue item



0944

Raccordo parete - plafone
Wall - ceiling joint

.01 Bianco - White

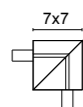

0,15 Kg



0948

Schermo in metacrilato satinato.
Satin methacrylate diffuser.

/100	105cm
/200	205cm
/300	305cm



0949

Copertura. - Polycarbonate screen.

/100	105cm
/200	205cm
/300	305cm



0945

2 testate di chiusura
2 end stoppers

.01 Bianco - White

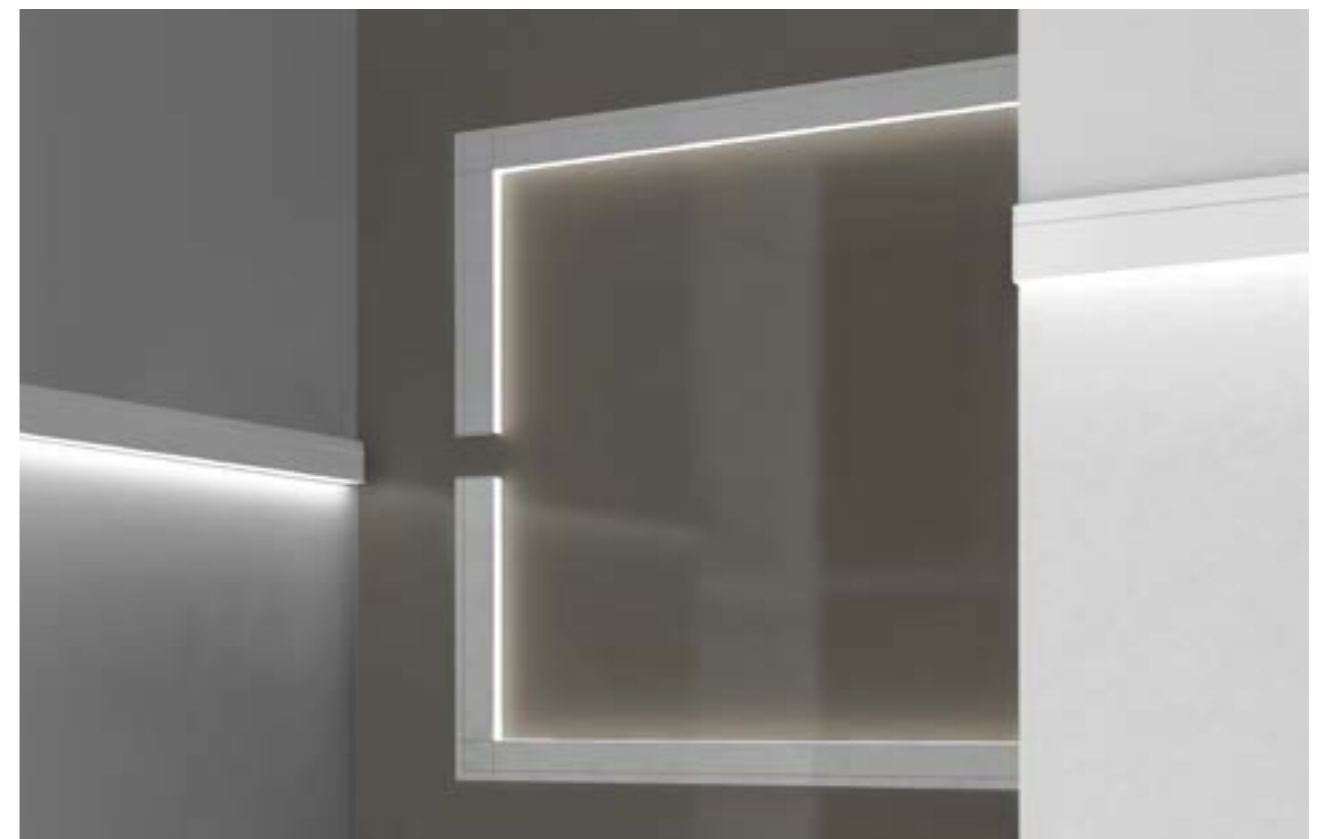

Esempio di configurazione - Configuration example

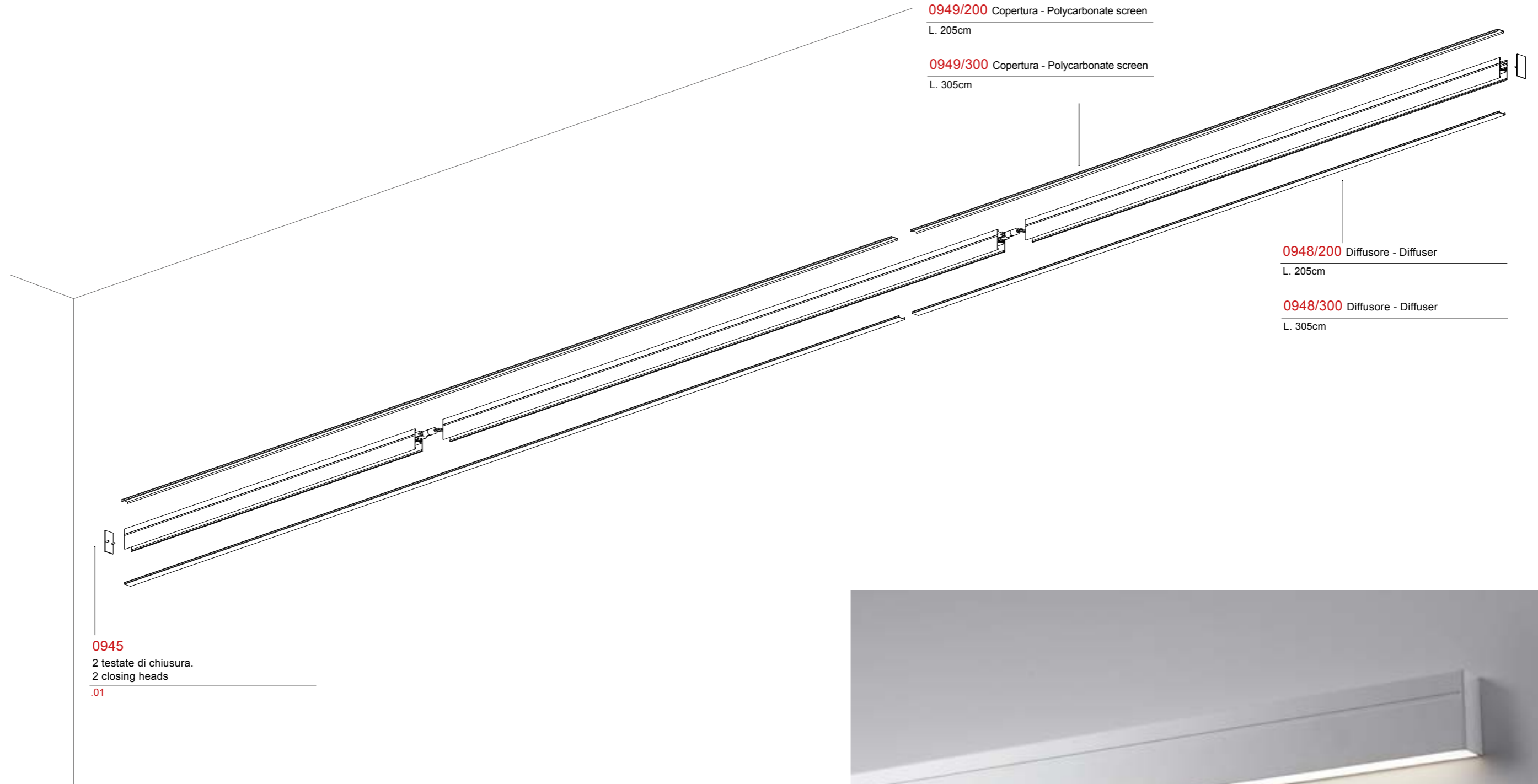

Lighting system

Lighting system

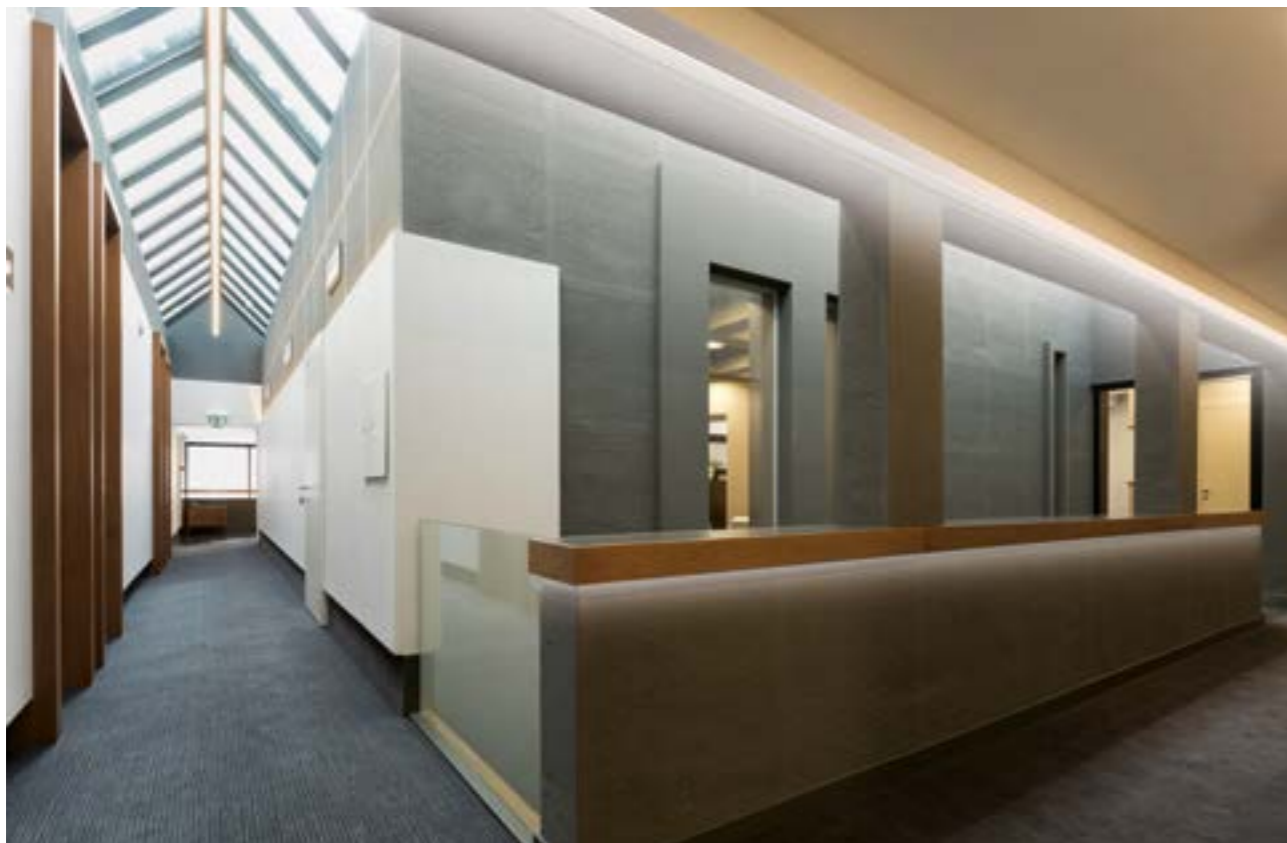

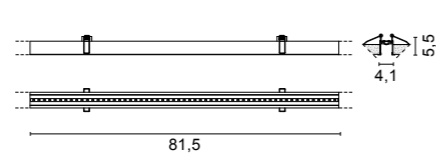

3,7x L cm.

6660 Rail System RECESSED

.01 Bianco - White

Color temperature	Light sources	lm
/W 4000K	LED 14,4W	1808lm
/WW 3000K	LED 14,4W	1616lm
/XW 2700K	LED 14,4W	1512lm



1,1 Kg

Nuova versione con circuito 18W/mt., 180 LED/mt. CRI>90.
New version with 18W/mt. strip LED, 180 LED / mt. CRI> 90.

A richiesta sono disponibili altre finiture.
Other finishes upon request.



Accessori - Accessories



0957
Angolo 90° - 90° corner
.01 Bianco - White

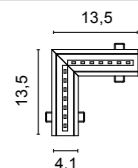

Color temperature	Light sources	lm
4000K	LED 3,6W	452lm
/WW 3000K	LED 3,6W	404lm
/XW 3000K	LED 3,6W	378lm



0,40 Kg



0956
Giunzione a croce - Cross joint
.01 Bianco - White

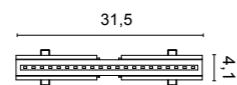

Color temperature	Light sources	lm
/W 4000K	LED 5,4W	678lm
/WW 3000K	LED 5,4W	606lm
/XW 3000K	LED 5,4W	567lm



0,35 Kg



0958
Giunzione a T - T joint
.01 Bianco - White

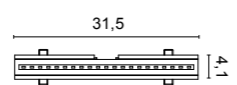

Color temperature	Light sources	lm
/W 4000K	LED 5,4W	678lm
/WW 3000K	LED 5,4W	606lm
/XW 3000K	LED 5,4W	567lm



0,35 Kg



0948
Schermo in metacrilato satinato.
Satin methacrylate diffuser.
/100 105cm
/200 205cm
/300 305cm

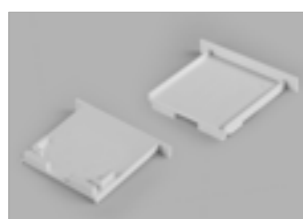

0939
2 testate di chiusura
2 end stoppers
.01 Bianco - White

CUSTOM SIZE

Tabella lunghezze disponibili a richiesta. - Table of available lengths on request.

cm.	watt	2700K (XW)	lm	3000K (WW)	lm	4000K (W)	lm
61,5	10,8W	A6660.01/60/XW	1134	A6660.01/60/WW	1212	A6660.01/60/W	1356
71,5	12,6W	A6660.01/70/XW	1323	A6660.01/70/WW	1414	A6660.01/70/W	1582
* 81,5	14,4W	6660.01/XW	1512	6660.01/WW	1616	6660.01/W	1808
91,5	16,2W	A6660.01/90/XW	1701	A6660.01/90/WW	1818	A6660.01/90/W	2034
101,5	18W	A6660.01/100/XW	1890	A6660.01/100/WW	2020	A6660.01/100/W	2260
111,5	19,8W	A6660.01/110/XW	2079	A6660.01/110/WW	2222	A6660.01/110/W	2486
121,5	21,6W	A6660.01/120/XW	2268	A6660.01/120/WW	2424	A6660.01/120/W	2712
131,5	23,4W	A6660.01/130/XW	2457	A6660.01/130/WW	2626	A6660.01/130/W	2938
141,5	25,2W	A6660.01/140/XW	2646	A6660.01/140/WW	2828	A6660.01/140/W	3164
151,5	27W	A6660.01/150/XW	2835	A6660.01/150/WW	3030	A6660.01/150/W	3390
161,5	28,8W	A6660.01/160/XW	3024	A6660.01/160/WW	3232	A6660.01/160/W	3616
171,5	30,6W	A6660.01/170/XW	3213	A6660.01/170/WW	3434	A6660.01/170/W	3842
181,5	32,4W	A6660.01/180/XW	3402	A6660.01/180/WW	3636	A6660.01/180/W	4068
191,5	34,2W	A6660.01/190/XW	3591	A6660.01/190/WW	3838	A6660.01/190/W	4294
201,5	36W	A6660.01/200/XW	3780	A6660.01/200/WW	4040	A6660.01/200/W	4520
211,5	37,8W	A6660.01/210/XW	3969	A6660.01/210/WW	4242	A6660.01/210/W	4746
221,5	39,6W	A6660.01/220/XW	4158	A6660.01/220/WW	4444	A6660.01/220/W	4972
231,5	41,4W	A6660.01/230/XW	4347	A6660.01/230/WW	4646	A6660.01/230/W	5198
241,5	43,2W	A6660.01/240/XW	4536	A6660.01/240/WW	4848	A6660.01/240/W	5424
251,5	45W	A6660.01/250/XW	4725	A6660.01/250/WW	5050	A6660.01/250/W	5650
261,5	46,8W	A6660.01/260/XW	4914	A6660.01/260/WW	5252	A6660.01/260/W	5876
271,5	48,6W	A6660.01/270/XW	5103	A6660.01/270/WW	5454	A6660.01/270/W	6102
281,5	50,4W	A6660.01/280/XW	5292	A6660.01/280/WW	5656	A6660.01/280/W	6328
291,5	52,2W	A6660.01/290/XW	5481	A6660.01/290/WW	5858	A6660.01/290/W	6554
301,5	54W	A6660.01/300/XW	5670	A6660.01/300/WW	6060	A6660.01/300/W	6780

* Articolo standard a catalogo - Standard catalogue item

FORO INCASSO - CUT OUT

La lunghezza totale del foro d'incasso si ottiene aggiungendo 0,6 cm alla somma delle lunghezze dei singoli pezzi.
Total length of the cutout is obtained by adding 0,6 cm to the sum of each component length.



Drivers ON/OFF

Cod.	0155	0156	0160	0157	0161/100	0162
	24V-13W	24V-25W	24V-50W	24V-75W	24V-100W	24V-150W

DIMMABLE drivers

Cod.	0110/DIM	0717/DIM60	0717/DIM100
	12/24V	24V-60W	24V-100W

LED emergency unit

Cod.	0115/EM
	Inverter + Battery + LED indicator

Solo collegamento in parallelo. - Only parallel connection.

Esempio di configurazione - Configuration example

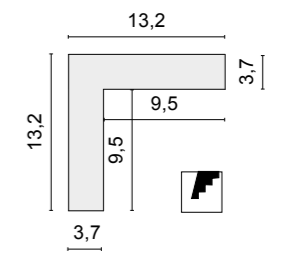
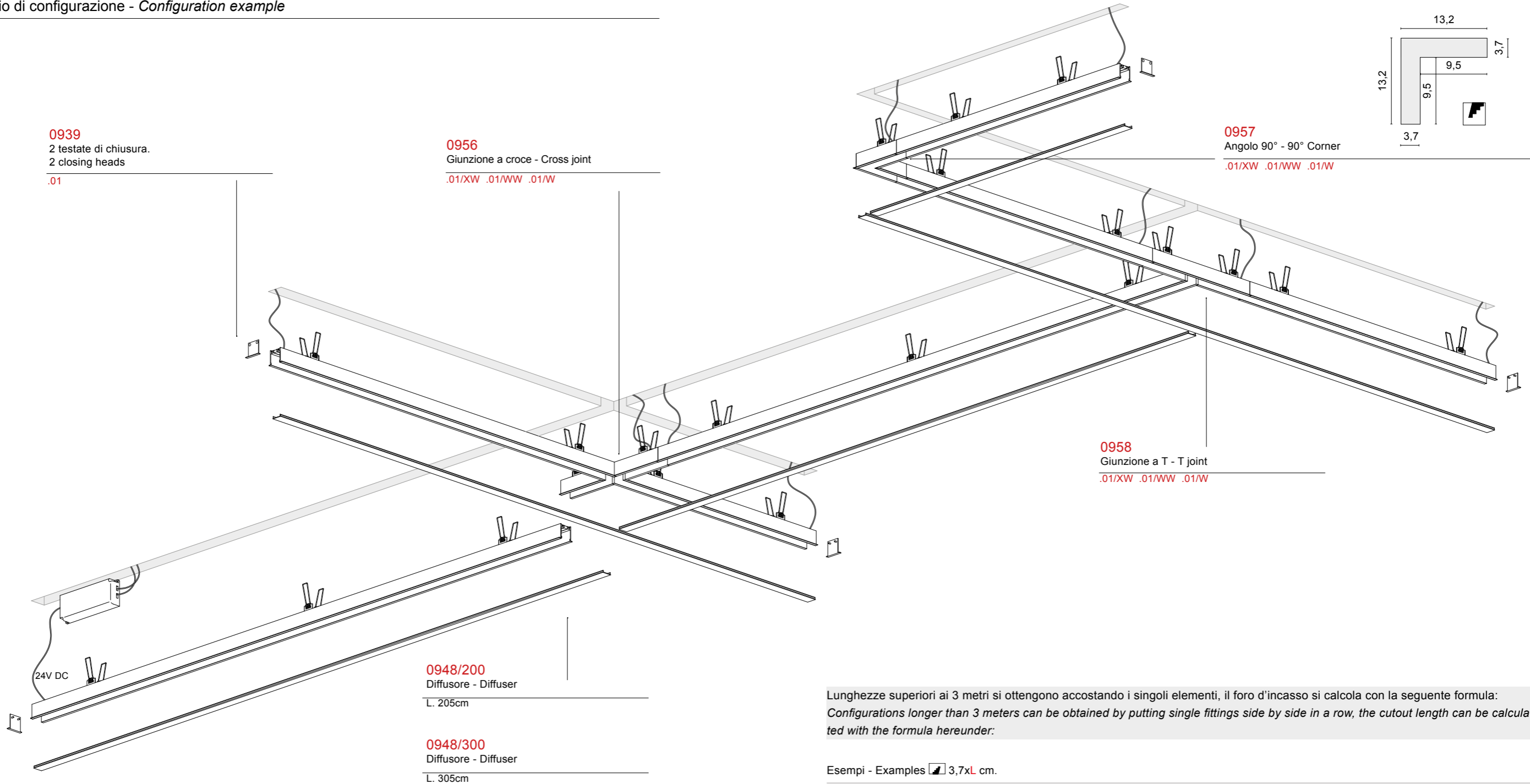

Lunghezze superiori ai 3 metri si ottengono accostando i singoli elementi, il foro d'incasso si calcola con la seguente formula:
Configurations longer than 3 meters can be obtained by putting single fittings side by side in a row, the cutout length can be calculated with the formula hereunder:

Esempi - Examples $3,7 \times L$ cm.

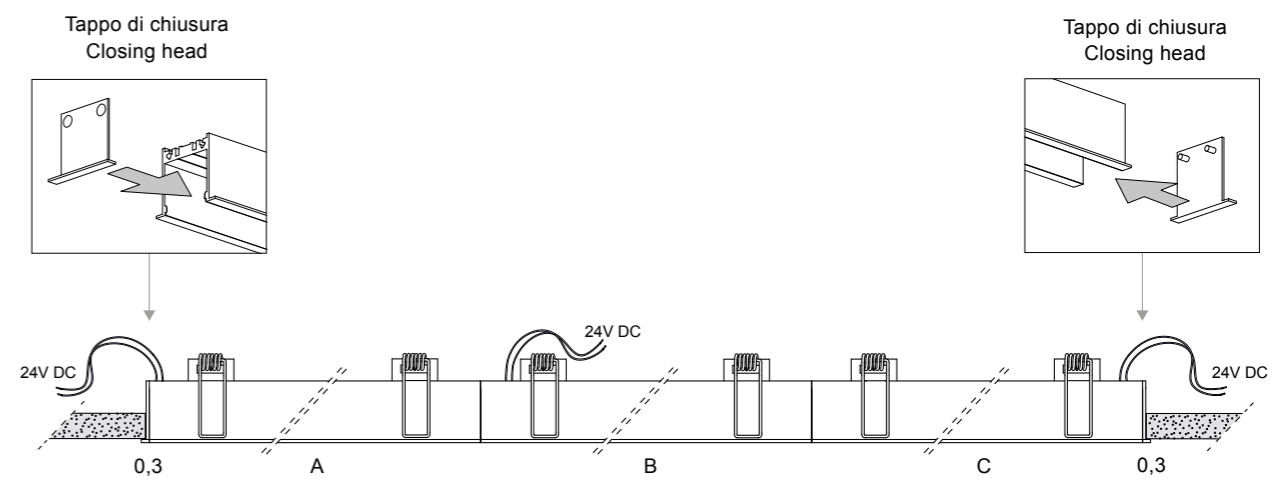

$$L = 0,3 + A + B + C + 0,3$$

A B C = Lunghezza delle lampade senza tappi di chiusura. Lamps length without closing heads.



0956



0957



0958

Sistema di apparecchi lineari LED da incasso con minitrim, il piccolo bordo in metacrilato consente un'installazione semplice che non richiede costose operazioni di rasatura, stuccatura e gessatura.

Profilo in metacrilato bianco satinato e dissipatore in alluminio anodizzato. I singoli apparecchi sono realizzati in varie lunghezze da 12 a 302 cm con modularità ogni 10cm (vedi tabella). Disponibili tre tonalità di luce (2700, 3000, 4000K) e versioni RGB. A richiesta vengono realizzati tagli ad angolo e versioni con altre tonalità di luce.

Da ordinare separatamente: alimentatori, dimmer DALI/1...10V/PUSH, gruppi emergenza, casseforme per muratura (solo per mod. LINEA).

LINEA – Larghezza 2,7 cm.
La versione standard utilizza circuiti LED flessibili da 15W/m - 1700Lm/m nominali (4000K).
Versione ETL disponibile a richiesta

LINEAMAXI – Larghezza 5,4 cm.
La versione standard utilizza circuiti LED flessibili da 18W/m - 2000Lm/m nominali (4000K).

System of recessed linear LED fixtures with minitrim, the small methacrylate trim allows easy installation avoiding expensive plastering operations.

Profile in white satin methacrylate and heatsink in anodized aluminum. Fixtures are produced in different lengths from 12 to 302 cm with modularity every 10 cm (see table). Three light tones available (2700, 3000, 4000K) and RGB options. Upon request we prepare fixtures with angled cuts and other light tones.

To be ordered separately: converters, dimmer DALI/1...10V/PUSH, emergency kit, box for concrete(only for LINEA).

LINEA – width 2,7 cm.
The standard option is fitted with flexible LED strip 15 W/m - 1700Lm/m gross output (4000K).
ETL version available upon request

LINEA MAXI – width 5,4 cm.
The standard option is fitted with flexible LED strip 18W/m - 2000Lm/m gross output (4000K).

Système d'appareils encastrables linéaires LED avec 'minitrim', la petite bordure en méthacrylate simplifie l'installation faisant aussi éparpner frais de plâtrerie et rasage.

Profil en méthacrylate blanc satiné et dissipateur de chaleur en aluminium anodisé. Les appareils sont produit dans différentes longueurs à partir de 12 jusqu'à 302 cm avec modularité 10cm (voir table).

Trois tonalité de lumière disponibles (2700, 3000, 4000K) et options RGB. Sur requête nous réalisons appareils avec découpage angulaire et autres tonalité de lumière.

À commander séparément: convertisseur, dimmer DALI/1...10V/PUSH, kit lumière de secours, boîte d'encastrément pour murs pleins(seulement pour LINEA).

LINEA – largeur 2,7 cm.
La version standard est équipé d'un circuit LED flexible 15W/m - 1700Lm/m émission (4000K).
Version ETL disponible sur demande

LINEA MAXI – largeur 5,4 cm.
La version standard est équipé d'un circuit LED flexible 18W/m - 2000Lm/m émission (4000K).

LINEA

design: U.T. EGOLUCE

Lineare LED Einbauleuchten-system mit 'minitrim'. Der kleine Rahmen aus Methacrylat ermöglicht eine einfache und billige Installation ohne Gipsfertigung.

Profil aus satiniertem Methacrylat weiß und Kühlkörper aus Aluminium eloxiert.

Die einzelne Elemente sind in verschiedenen Längen verfügbar: von 12 bis 302 cm, mit Modularität je 10 cm (siehe Tabelle).

Erhältlich in drei Lichtfarben (2700, 3000 oder 4000K) oder RGB.

Auf Anfrage vorbereiten wir Sonderausführungen mit eckeschnitt oder mit andere Lichtfarbe.

Separat zu bestellen: Konverter, dimmer DALI/1...10V/PUSH, Notbeleuchtung, Einbaudose (nur für LINEA).

LINEA – Breite 2,7 cm.
Die Standardversion ist mit flexible LED Leisten 15W/m - 1700Lm/m (4000K) versehen.

LINEA – Breite 5,4 cm.
Die Standardversion ist mit flexible LED Leisten 18W/m - 2000Lm/m (4000K). versehen.

Systema empotrable de aparatos LED lineares con 'minitrim', el pequeño marco de metacrilato permite una instalación simplifica da y ahorra toda las operaciones de acabado del yeso.

Perfil de metacrilato satinado y dissipador de calor en aluminio anodizado.

Los aparatos son producidos en diferentes larguras desde 12 hasta 302 cm y modularidad cada 10 cm (ver tabla).

Tres tonos de luz disponibles (2700, 3000 y 4000K) y RGB.

A pedido se realizan versiones con corte angular y otros tonos de luz.

A pedir por separado: Convertidor, dimmer DALI/1...10V/PUSH, luz de emergencia, caja para empotrar (solo por Linea).

LINEA – Ancho 2,7 cm.
Las versiones standard disfrutan un circuito LED 15W/m - 1700 Lm/m (4000K).

LINEA MAXI – Ancho 5,4 cm.
Las versiones standard disfrutan un circuito LED 18W/m - 2000 Lm/m (4000K).

Система встраиваемых линейных светодиодных светильников с тонкой рамкой из метакрилата, облегчающей установку светильника без сложных и затратных штукатурных работ.

Профиль из сатинированного белого метакрилата, теплоотвод из экструдированного алюминия.

Выпускается в различных стандартных длинах от 12 до 302 см с шагом 10 см (см. таблицу), трех цветовых температурах (2700, 3000 и 4000K) или RGB.

По запросу производятся светильники, которые можно стыковать под углом, а также в других цветовых температурах.

Отдельно заказываются: блоки питания, DALI/1...10V/PUSH, аварийные блоки, коробка для установки в бетон (только для серии LINEA).

LINEA – ширина 2,7 см.
Стандартная версия комплектуется гибкой светодиодной лентой LED strip 15 Вт/м, световой поток 1700лм/м (4000K).

LINEA MAXI – ширина 5,4 см.
Стандартная версия комплектуется гибкой светодиодной лентой LED strip 18 Вт/м, световой поток 2000лм/м (4000K).

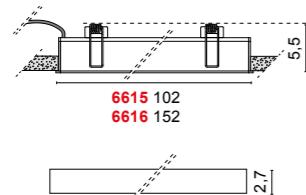

6615 Linea
.01 Bianco - White

Color temperature	Light sources	lm
/W 4000K	LED 24V 15W	1840lm
/WW 3000K	LED 24V 15W	1650lm
/XW 2700K	LED 24V 15W	1560lm

Versione ETL disponibile a richiesta.
ETL version available upon request.

- 6615 101,5x2,2 cm.
- 6616 151,5x2,2 cm.

6616 Linea
.01 Bianco - White

Color temperature	Light sources	lm
/W 4000K	LED 24V 22,5W	2760lm
/WW 3000K	LED 24V 22,5W	2475lm
/XW 2700K	LED 24V 22,5W	2340lm

Versione ETL disponibile a richiesta.
ETL version available upon request.

LINEA RGB

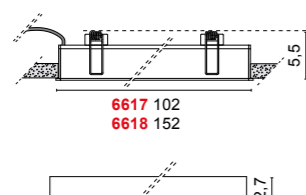

6617 Linea RGB
.01 Bianco - White

Light sources
LED 14,4W 24V

Versione ETL disponibile a richiesta.
ETL version available upon request.

- 6617 101,5x2,2 cm.
- 6618 151,5x2,2 cm.

6618 Linea RGB
.01 Bianco - White

Light sources
LED 21,6W 24V

Versione ETL disponibile a richiesta.
ETL version available upon request.

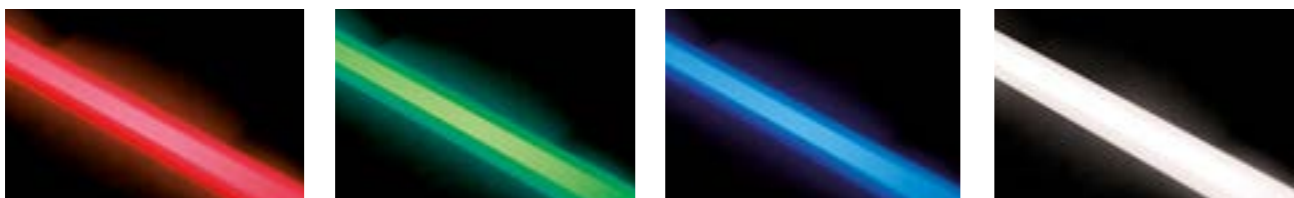

CUSTOM SIZE

Tabella lunghezze disponibili a richiesta. Le misure si riferiscono alle lunghezze totali delle lampade comprese di tappi terminali. N.B. senza tappi: - 1 cm.
Table of available lengths on request. Measures are referred to complete fixtures including closing heads. Attention: Without closing heads: - 1 cm.

cm.	watt	cm.	2700K (XW)	lm	3000K (WW)	lm	4000K (W)	lm	RGB
12	1,5W	11,5x2,2	A6615.01/10/XW	156	A6615.01/10/WW	165	A6615.01/10/W	184	A6615.01/10RGB
22	3W	21,5x2,2	A6615.01/20/XW	312	A6615.01/20/WW	330	A6615.01/20/W	368	A6615.01/20RGB
32	4,5W	31,5x2,2	A6615.01/30/XW	468	A6615.01/30/WW	495	A6615.01/30/W	552	A6615.01/30RGB
42	6W	41,5x2,2	A6615.01/40/XW	624	A6615.01/40/WW	660	A6615.01/40/W	736	A6615.01/40RGB
52	7,5W	51,5x2,2	A6615.01/50/XW	780	A6615.01/50/WW	895	A6615.01/50/W	920	A6615.01/50RGB
62	9W	61,5x2,2	A6615.01/60/XW	936	A6615.01/60/WW	990	A6615.01/60/W	1104	A6615.01/60RGB
72	10,5W	71,5x2,2	A6615.01/70/XW	1092	A6615.01/70/WW	1155	A6615.01/70/W	1288	A6615.01/70RGB
82	12W	81,5x2,2	A6615.01/80/XW	1248	A6615.01/80/WW	1320	A6615.01/80/W	1472	A6615.01/80RGB
92	13,5W	91,5x2,2	A6615.01/90/XW	1404	A6615.01/90/WW	1485	A6615.01/90/W	1656	A6615.01/90RGB
102	15W	101,5x2,2	6615.01/XW *	1560	6615.01/WW *	1650	6615.01/W *	1840	6617.01 *
112	16,5W	111,5x2,2	A6615.01/110/XW	1716	A6615.01/110/WW	1815	A6615.01/110/W	2024	A6615.01/110RGB
122	18W	121,5x2,2	A6615.01/120/XW	1872	A6615.01/120/WW	1980	A6615.01/120/W	2208	A6615.01/120RGB
132	19,5W	131,5x2,2	A6615.01/130/XW	2028	A6615.01/130/WW	2145	A6615.01/130/W	2392	A6615.01/130RGB
142	21W	141,5x2,2	A6615.01/140/XW	2184	A6615.01/140/WW	2310	A6615.01/140/W	2576	A6615.01/140RGB
152	22,5W	151,5x2,2	6616.01/XW *	2340	6616.01/WW *	2475	6616.01/W *	2760	6618.01 *
162	24W	161,5x2,2	A6615.01/160/XW	2496	A6615.01/160/WW	2640	A6615.01/160/W	2944	A6615.01/160RGB
172	25,5W	171,5x2,2	A6615.01/170/XW	2652	A6615.01/170/WW	2805	A6615.01/170/W	3128	A6615.01/170RGB
182	27W	181,5x2,2	A6615.01/180/XW	2808	A6615.01/180/WW	2970	A6615.01/180/W	3312	A6615.01/180RGB
192	28,5W	191,5x2,2	A6615.01/190/XW	2964	A6615.01/190/WW	3135	A6615.01/190/W	3496	A6615.01/190RGB
202	30W	201,5x2,2	A6615.01/200/XW	3120	A6615.01/200/WW	3300	A6615.01/200/W	3680	A6615.01/200RGB
212	31,5W	211,5x2,2	A6615.01/210/XW	3276	A6615.01/210/WW	3465	A6615.01/210/W	3864	A6615.01/210RGB
222	33W	221,5x2,2	A6615.01/220/XW	3432	A6615.01/220/WW	3630	A6615.01/220/W	4048	A6615.01/220RGB
232	34,5W	231,5x2,2	A6615.01/230/XW	3588	A6615.01/230/WW	3795	A6615.01/230/W	4232	A6615.01/230RGB
242	36W	241,5x2,2	A6615.01/240/XW	3744	A6615.01/240/WW	3960	A6615.01/240/W	4416	A6615.01/240RGB
252	37,5W	251,5x2,2	A6615.01/250/XW	3900	A6615.01/250/WW	4125	A6615.01/250/W	4600	A6615.01/250RGB
262	39W	261,5x2,2	A6615.01/260/XW	4056	A6615.01/260/WW	4290	A6615.01/260/W	4784	A6615.01/260RGB
272	40,5W	271,5x2,2	A6615.01/270/XW	4212	A6615.01/270/WW	4455	A6615.01/270/W	4968	A6615.01/270RGB
282	42W	281,5x2,2	A6615.01/280/XW	4368	A6615.01/280/WW	4620	A6615.01/280/W	5152	A6615.01/280RGB
292	43,5W	291,5x2,2	A6615.01/290/XW	4524	A6615.01/290/WW	4785	A6615.01/290/W	5336	A6615.01/290RGB
302	45W	301,5x2,2	A6615.01/300/XW	4680	A6615.01/300/WW	4950	A6615.01/300/W	5520	A6615.01/300RGB

* Articolo standard a catalogo - Standard catalogue item

Accessori - Accessories



- 0210/100 101,8cm
- 0210/150 151,8cm
- 0210/200 201,8cm
- 0210/300 301,8cm

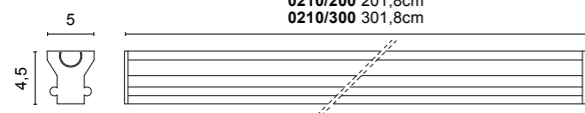

0210

Cassaforma per calcestruzzo.
Wallbox for concrete.

/100	101,8cm	6x105x5cm
/150	151,8cm	6x155x5cm
/200	201,8cm	6x205x5cm
/300	301,8cm	6x305x5cm



0242

Profilo angolare opzionale per facilitare l'installazione nel cartongesso.
Optional L shaped profile to ease installation into plasterboard.

- /100 100cm
- /200 200cm
- /300 300cm

Drivers ON/OFF

Cod.	0155	0156	0160	0157	0161/100	0162
	24V-13W	24V-25W	24V-50W	24V-75W	24V-100W	24V-150W

DIMMABLE drivers

Cod.	0110/DIM	0717/DIM60	0717/DIM100
	12/24V	24V-60W	24V-100W

LED emergency unit

Cod.	0115/EM
	Inverter + Battery + LED indicator

RGB drivers

Cod.	0164	0167	Driver RGB Casambi
	120W	22W	0164/CASA
	IN:230V - OUT: 3x24V		120W
			IN:230V - OUT: 3x24V

0163	0165	0166
IR Sensor	IR Remote controller	Sinc Cable

Solo collegamento in parallelo. - Only parallel connection.



Lunghezze superiori ai 3 metri si ottengono accostando i singoli elementi, il foro d'incasso si calcola con la seguente formula:
Configurations longer than 3 meters can be obtained by putting single fittings side by side in a row, the cutout length can be calculated with the formula hereunder:

Esempi - Examples $2,2 \times L$ cm.

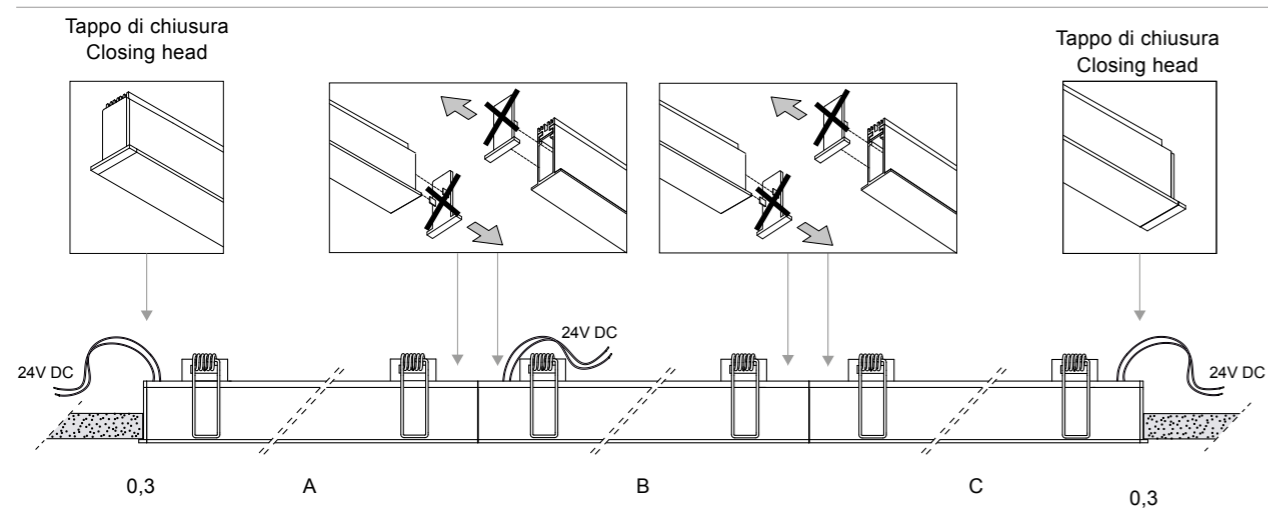

$$L = 0,3 + A + B + C + 0,3$$

A B C = Lunghezza delle lampade senza tappi di chiusura. Lamps length without closing heads.

Lighting system



Su richiesta sono disponibili soluzioni angolari a 90° - 90° angled options are available upon request



Lighting system

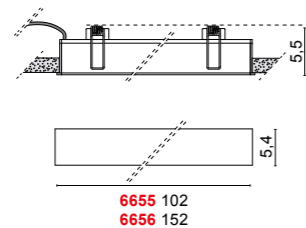

6655 102
6656 152

6655 101,5x4,8 cm.
6656 151,5x4,8 cm.

6655 Linea Maxi
.01 Bianco - White

Color temperature	Light sources	lm
/W 4000K	LED 24V 18W	2260lm
/WW 3000K	LED 24V 18W	2020lm
/XW 2700K	LED 24V 18W	1890lm

Versione ETL disponibile a richiesta.
ETL version available upon request.

6656 Linea Maxi
.01 Bianco - White

Color temperature	Light sources	lm
/W 4000K	LED 24V 27W	3390lm
/WW 3000K	LED 24V 27W	3030lm
/XW 2700K	LED 24V 27W	2835lm

Versione ETL disponibile a richiesta.
ETL version available upon request.

Opportunamente installato garantisce UGR < 19 (Indice unificato d'abbagliamento)
Conveniently positioned grants an UGR < 19 (Unified Glare Rating)

LINEA MAXI RGB

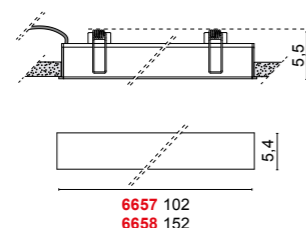

6657 102
6658 152

6657 101,5x4,8 cm.
6658 151,5x4,8 cm.

6657 Linea Maxi RGB
.01 Bianco - White

Light sources
LED 14,4W 24V

Versione ETL disponibile a richiesta.
ETL version available upon request.

6658 Linea Maxi RGB
.01 Bianco - White

Light sources
LED 21,6W 24V

Versione ETL disponibile a richiesta.
ETL version available upon request.

CUSTOM SIZE

Tabella lunghezze disponibili a richiesta. Le misure si riferiscono alle lunghezze totali delle lampade comprese di tappi terminali.
N.B. senza tappi: - 1 cm.
Table of available lengths on request. Measures are referred to complete fixtures including closing heads.
Attention: Without closing heads: - 1 cm.

cm.	watt	cm.	2700K (XW)	lm	3000K (WW)	lm	4000K (W)	lm	RGB
12	1,8W	11,5x4,8	A6655.01/10/XW	189	A6655.01/10/WW	202	A6655.01/10/W	226	A6655.01/10RGB
22	3,6W	21,5x4,8	A6655.01/20/XW	378	A6655.01/20/WW	404	A6655.01/20/W	452	A6655.01/20RGB
32	5,4W	31,5x4,8	A6655.01/30/XW	567	A6655.01/30/WW	606	A6655.01/30/W	678	A6655.01/30RGB
42	7,2W	41,5x4,8	A6655.01/40/XW	756	A6655.01/40/WW	808	A6655.01/40/W	904	A6655.01/40RGB
52	9W	51,5x4,8	A6655.01/50/XW	645	A6655.01/50/WW	1010	A6655.01/50/W	1130	A6655.01/50RGB
62	10,8W	61,5x4,8	A6655.01/60/XW	1134	A6655.01/60/WW	1212	A6655.01/60/W	1356	A6655.01/60RGB
72	12,6W	71,5x4,8	A6655.01/70/XW	1323	A6655.01/70/WW	1414	A6655.01/70/W	1582	A6655.01/70RGB
82	14,4W	81,5x4,8	A6655.01/80/XW	1512	A6655.01/80/WW	1616	A6655.01/80/W	1808	A6655.01/80RGB
92	16,2W	91,5x4,8	A6655.01/90/XW	1701	A6655.01/90/WW	1818	A6655.01/90/W	2034	A6655.01/90RGB
102	18W	101,5x4,8	6655.01/XW *	1890	6655.01/WW *	2020	6655.01/W *	2260	6657.01 *
112	19,8W	111,5x4,8	A6655.01/110/XW	2079	A6655.01/110/WW	2222	A6655.01/110/W	2486	A6655.01/110RGB
122	21,6W	121,5x4,8	A6655.01/120/XW	2268	A6655.01/120/WW	2424	A6655.01/120/W	2712	A6655.01/120RGB
132	23,4W	131,5x4,8	A6655.01/130/XW	2457	A6655.01/130/WW	2626	A6655.01/130/W	2938	A6655.01/130RGB
142	25,2W	141,5x4,8	A6655.01/140/XW	2646	A6655.01/140/WW	2828	A6655.01/140/W	3164	A6655.01/140RGB
152	27W	151,5x4,8	6656.01/XW *	2835	6656.01/WW *	3030	6656.01/W *	3390	6658.01 *
162	28,8W	161,5x4,8	A6655.01/160/XW	3024	A6655.01/160/WW	3232	A6655.01/160/W	3616	A6655.01/160RGB
172	30,6W	171,5x4,8	A6655.01/170/XW	3213	A6655.01/170/WW	3434	A6655.01/170/W	3842	A6655.01/170RGB
182	32,4W	181,5x4,8	A6655.01/180/XW	3402	A6655.01/180/WW	3636	A6655.01/180/W	4068	A6655.01/180RGB
192	34,2W	191,5x4,8	A6655.01/190/XW	3591	A6655.01/190/WW	3838	A6655.01/190/W	4294	A6655.01/190RGB
202	36W	201,5x4,8	A6655.01/200/XW	3780	A6655.01/200/WW	4040	A6655.01/200/W	4520	A6655.01/200RGB
212	37,8W	211,5x4,8	A6655.01/210/XW	3969	A6655.01/210/WW	4242	A6655.01/210/W	4746	A6655.01/210RGB
222	39,6W	221,5x4,8	A6655.01/220/XW	4158	A6655.01/220/WW	4444	A6655.01/220/W	4972	A6655.01/220RGB
232	41,4W	231,5x4,8	A6655.01/230/XW	4347	A6655.01/230/WW	4646	A6655.01/230/W	5198	A6655.01/230RGB
242	43,2W	241,5x4,8	A6655.01/240/XW	4536	A6655.01/240/WW	4848	A6655.01/240/W	5424	A6655.01/240RGB
252	45W	251,5x4,8	A6655.01/250/XW	4725	A6655.01/250/WW	5050	A6655.01/250/W	5650	A6655.01/250RGB
262	46,8W	261,5x4,8	A6655.01/260/XW	4914	A6655.01/260/WW	5252	A6655.01/260/W	5876	A6655.01/260RGB
272	48,6W	271,5x4,8	A6655.01/270/XW	5103	A6655.01/270/WW	5454	A6655.01/270/W	6102	A6655.01/270RGB
282	50,4W	281,5x4,8	A6655.01/280/XW	5292	A6655.01/280/WW	5656	A6655.01/280/W	6328	A6655.01/280RGB
292	52,2W	291,5x4,8	A6655.01/290/XW	5481	A6655.01/290/WW	5858	A6655.01/290/W	6554	A6655.01/290RGB
302	54W	301,5x4,8	A6655.01/300/XW	5670	A6655.01/300/WW	6060	A6655.01/300/W	6780	A6655.01/300RGB

* Articolo standard a catalogo - Standard catalogue item

Accessori - Accessories



0242

Profilo angolare opzionale per facilitare l'installazione nel cartongesso.
Optional L shaped profile to ease installation into plasterboard.

/100	100cm
/200	200cm
/300	300cm

Drivers ON/OFF

Cod.	0155	0156	0160	0157	0161/100	0162
	24V-13W	24V-25W	24V-50W	24V-75W	24V-100W	24V-150W

DIMMABLE drivers

Cod.	0110/DIM	0717/DIM60	0717/DIM100
	12/24V	24V-60W	24V-100W

LED emergency unit

Cod.	0115/EM
	Inverter + Battery + LED indicator

RGB drivers

Cod.	0164	0167	Driver RGB Casambi	0163	0165	0166
	120W	22W	0164/CASA	IR Sensor	IR Remote controller	Sinc Cable
	IN:230V - OUT: 3x24V		IN:230V - OUT: 3x24V			

Solo collegamento in parallelo. - Only parallel connection.



Lunghezze superiori ai 3 metri si ottengono accostando i singoli elementi, il foro d'incasso si calcola con la seguente formula:
Configurations longer than 3 meters can be obtained by putting single fittings side by side in a row, the cutout length can be calculated with the formula hereunder:

Esempi - Examples  4,8xL cm.

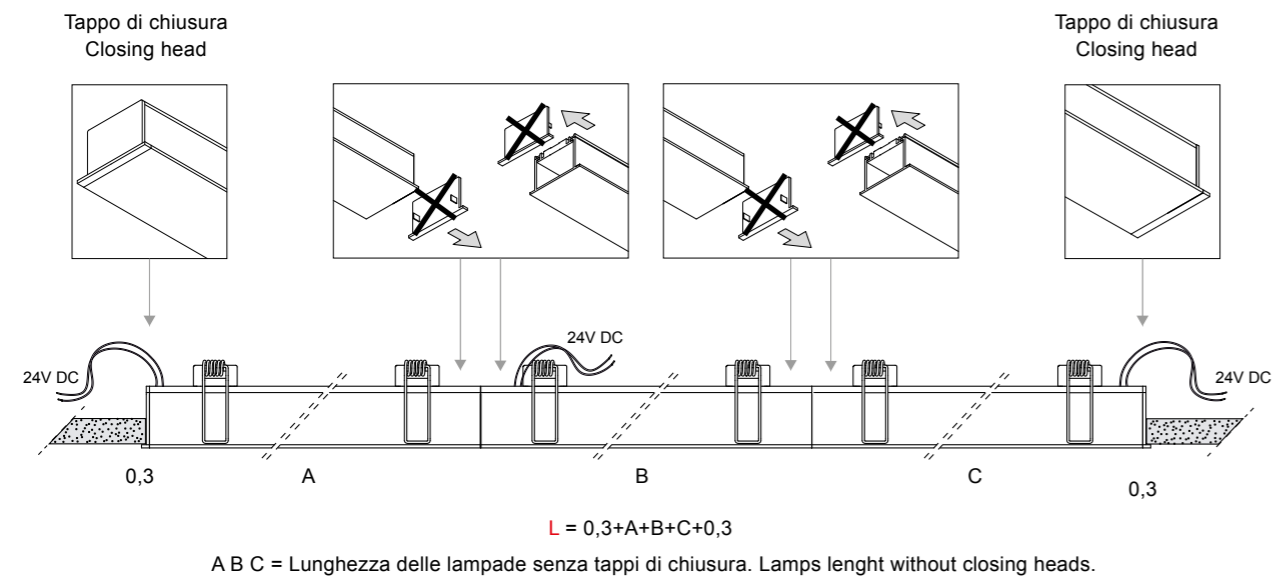

Su richiesta sono disponibili soluzioni angolari a 90° - 90° angled options are available upon request



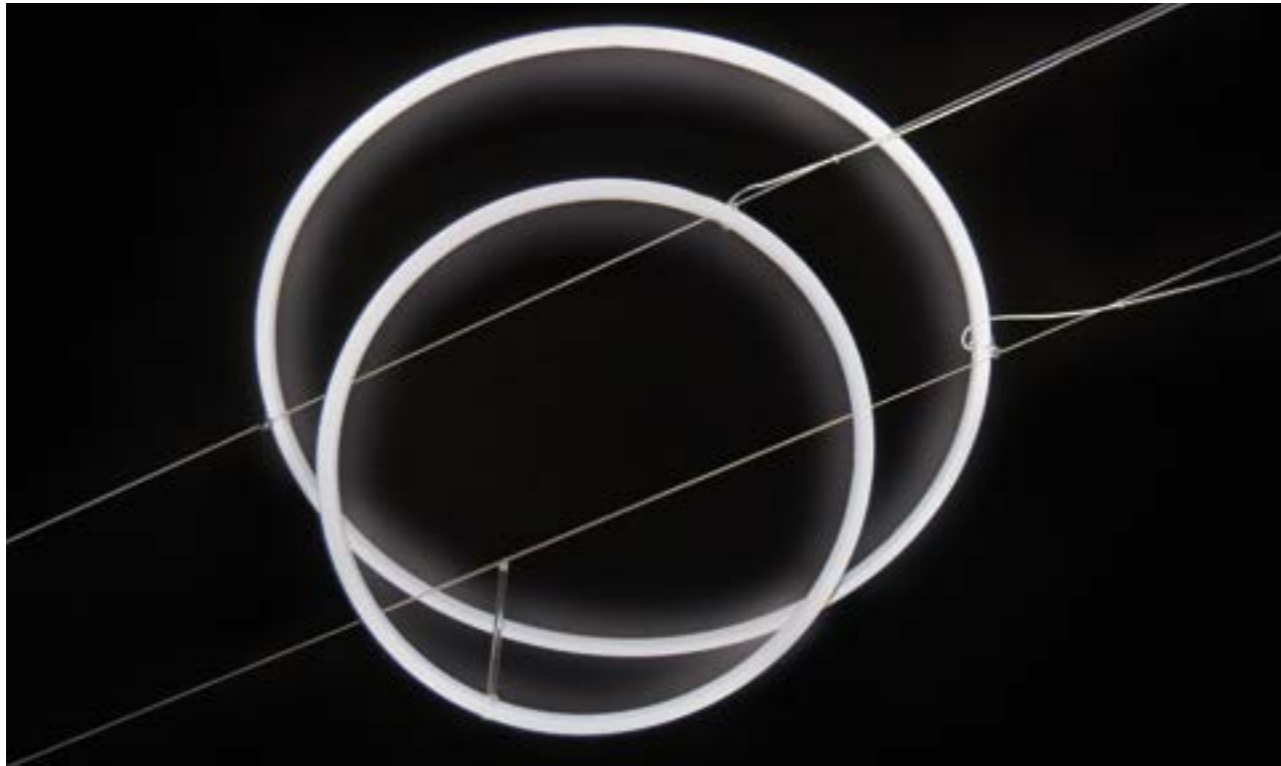

Systèmes de lumière diffusée, soit linéaires, soit rondes en aluminium avec diffuseurs en polycarbonate opale accroché sur câbles en acier.

Les profilés linéaires (100,150 et 200cms) sont accrochés sur un seul câble et , en tournant sur eux-mêmes, fournissent une lumière directe ou indirecte.

Les modèles ronds sont accrochés à deux câbles et, avec des accessoires dédiés, peuvent tourner ou être penchés

LANCIA CAVO est proposée en blanc mat RAL9016, noir mat , et en finissage chromé ou doré satiné. Le système permet de installer les lampes là ou vous voulez en partant d'une seule alimentation.

Le rosace contient l'alimentateur. Le câble est tendu entre deux systèmes d'attelage jusqu'à une longueur de 6 mt, mais, sur demande, câbles de 10 mt. Lumière disponible à 2700K (XW), 3000K (WW), et 4000K (W) en CRI>90, le nombre de 180 LEDS sur le circuit donne une lumière continue et uniforme, aussi disponibles en versions réglables.

Sur demande solutions avec alimentation passant d'une lampe à l'autre.

Sistemas de luz difusa sobre cables de acero. Los modelos propuestos son lineales o redondos con cuerpos de aluminio y difusores de policarbonato opal.

Los perfiles lineales de 100, 150 y 200 cm. Están posicionados sobre un solo cable de acero.

Pueden rotar para permitir una luz difusa directa o indirecta.

Los acabados son blanco mate RAL 9016 (.01) y negro mate RAL 9005 (.02)

Las soluciones redondas tienen 35, 50 y 70 cm de diámetro. Los cuerpos se colocan en apoyo sobre un par de cables de acero y, con los accesorios adecuados, se pueden girar e inclinar.

LANCIA TONDA cavo (cable) está disponible en blanco mate RAL 9016 (.01), negro (.02) o en dorado mate (.25) o cromado (.31).

El sistema permite colocar las lámparas a lo largo de los cables en el punto deseado a partir de una sola fuente de alimentación de pared o techo.

La roseta contiene el transformador. El cable de acero se estira entre dos tirantes opuestos y cubre distancias hasta 6 metros. A pedido también cables de 10 metros.

La luz LED está disponible en 2700K (XW), 3000K (WW) y 4000K (W) con un valor CRI> 90. La cantidad de LED en el circuito es de 180 por metro ofrece una luz continua y uniforme respetando el confort visual. Versiones dimables están disponibles.

A pedido, también se ofrecen soluciones que permiten la conexión de varios cuerpos con cables de alimentación que pasan de una lámpara a otra.

Streulichtanlagen an Stahlseilen. Die vorgeschlagenen Modelle sind linear oder rund mit Aluminiumkörpern und opalen Polycarbonatdiffusoren.

Die linearen Profile von 100, 150 und 200 cm. Sie sind auf einem einzigen Stahlseil angeordnet. Sie können sich um ihre eigene Achse drehen, um direktes oder indirektes Streulicht zu ermöglichen. Die Oberflächen sind mattweiß (.01) und mattschwarz (.02).

Die runden Lösungen haben einen Durchmesser von 35, 50 und 70 cm. Die Körper ruhen auf einem Paar Stahlseilen und können mit entsprechendem Zubehör gedreht und gekippt werden.

LANCIA TONDA-Kabel sind in den Farben Mattweiß (.01), Schwarz (.02) oder Gebürstetes Gold (.25) oder Chrom (.31) erhältlich.

Das System ermöglicht die Platzierung der Lampen entlang der Kabel an der gewünschten Stelle, beginnend mit einer einzelnen Wand- oder Deckenstromversorgung.

Die Rosette enthält den Transformator. Das Stahlseil wird zwischen zwei gegenüberliegenden Zugstangen gespannt und überbrückt Entfernungen von bis zu 6 Metern. 10 Meter Kabel erhältlich.

Das LED-Licht ist mit 2700K (XW), 3000K (WW) und 4000K (W) mit einem CRI> 90 erhältlich. Die Anzahl der LEDs auf dem 180er-Stromkreis pro Meter sorgt für kontinuierliches und gleichmäßiges Licht unter Wahrung des Sehkomforts. Dimmbare Versionen sind verfügbar.

Auf Anfrage werden auch Lösungen angeboten, die die Verbindung mehrerer Gehäuse mit Stromkabeln von Lampe zu Lampe ermöglichen.

Системы рассеянного света на стальных тросах. Предлагаются линейные и круглые модели с корпусом из алюминия и диффузором из матового поликарбоната.

Линейные профили длиной 100, 150 и 200 см располагаются на одном стальном тросе.

Могут вращаться вокруг своей оси, таким образом получается прямой или рассеянный свет.

Цвет белый матовый RAL 9016 (.01) и черный матовый RAL 9005 (.02).

Круглые варианты диаметром 35, 50 и 70см. Корпус опирается на пару стальных тросов и с помощью аксессуаров

может вращаться или наклоняться. Lancia Tonda на тросе предлагается окрашенной в белый матовый цвет RAL 9016 (.01), черный (.02) или брашированное золото (.25) или хром (.31).

Система позволяет располагать лампы вдоль троса на любом месте, начиная от силового ввода на стене или потолке. В розетке находится трансформатор. Стальной трос натянут между двумя противоположными креплениями на длину до 6 метров. По запросу трос до 10 метров.

Светодиоды могут быть 2700K (XW), 3000K (WW) и 4000K (W) и CRI более 90. Количество светодиодов

180 на метр дает ровный протяженный свет, что комфортно для глаз. Есть диммируемые варианты. По запросу есть другие решения, позволяющие соединять больше устройств с помощью силовых кабелей, проходящих от одного к другому.



SISTEMA LANCIA CAVO design: U.T. EGOLUCE

Sistemi di luce diffusa su cavi d'acciaio. I modelli proposti sono lineari o tonde con corpi in alluminio e diffusori in policarbonato opale.

I profili lineari di 100, 150 e 200 cm. sono disposti su un unico cavo d'acciaio. Possono ruotare sul proprio asse consentendo di avere una luce diffusa diretta o indiretta. Le finiture sono il bianco opaco RAL 9016 (.01) e il nero opaco RAL 9005 (.02).

Le soluzioni tonde sono di diametro 35, 50 e 70 cm. I corpi sono posizionati in appoggio su una coppia di cavi d'acciaio e, con appositi accessori, possono essere ruotati e inclinati. LANCIA TONDA cavo è proposta in verniciato bianco RAL 9016 opaco (.01), nero (.02) o in finitura oro spazzolato (.25), o cromato (.31).

Il sistema consente di disporre le lampade lungo i cavi nel punto desiderato partendo da un'unica alimentazione a parete o soffitto. Il rosone contiene il trasformatore. Il cavo d'acciaio è teso tra due tiranti contrapposti e copre distanze fino a 6 mt. A disposizione cavi di 10 metri.

La luce LED è disponibile a 2700K (XW), 3000 (WW) e 4000K (W) con un valore di CRI superiore a 90. Il numero di LED sul circuito 180 al metro offre una luce continua e uniforme nel rispetto del confort visivo. Sono disponibili versioni dimmerabili.

A richiesta sono fornite anche soluzioni che prevedono il collegamento di più corpi con cavi alimentazione passanti da lampada a lampada.

Diffused light systems on steel cables. The proposed models are linear or round with aluminum bodies and opal polycarbonate diffusers.

The linear profiles of 100, 150 and 200 cm. they are arranged on a single steel cable. They can rotate on their own axis allowing for direct or indirect diffused light. The finishes are matt white RAL 9016 (.01) and matt black RAL 9005 (.02).

The round solutions are 35, 50 and 70 cm in diameter. The bodies are positioned resting on a pair of steel cables and, with special accessories, can be rotated and inclined. LANCIA TONDA corda is available in matt white RAL 9016 (.01), black (.02) or brushed gold (.25), or chromed (.31) finish.

The system allows you to arrange the lamps along the cables at the desired point starting from a single power supply to the wall or ceiling. The rose window contains the transformer. The steel cable is stretched between two opposing tie rods and covers distances of up to 6 meters. 10m cables available.

The LED light is available at 2700K (XW), 3000 (WW) and 4000K (W) with a CRI value greater than 90. The number of LEDs on the circuit 180 per meter offers continuous and uniform light while respecting visual comfort. Dimmable versions are available.

Solutions that provide for the connection of multiple bodies with power cables passing from lamp to lamp are also available on request.

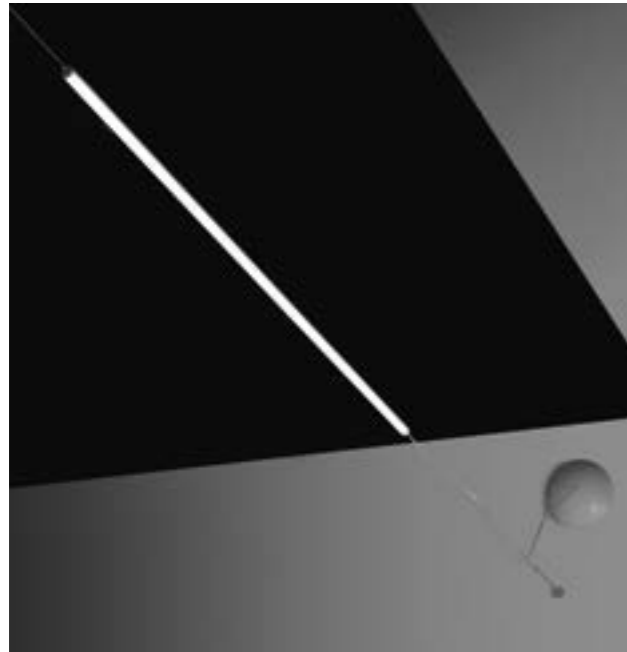

1565 Lancia Cavo

- .01** Bianco - White
- .02** Nero - Black

L. 100cm 0,80 Kg

Color temperature	Light sources	lm
/100/W 4000K	LED 18W	2260lm
/100/WW 3000K	LED 18W	2020lm
/100/XW 2700K	LED 18W	1890lm

L. 150cm 1,00 Kg

Color temperature	Light sources	lm
/150/W 4000K	LED 27W	3390lm
/150/WW 3000K	LED 27W	3030lm
/150/XW 2700K	LED 27W	2835lm

L. 200cm 1,20 Kg

Color temperature	Light sources	lm
/200/W 4000K	LED 36W	4520lm
/200/WW 3000K	LED 36W	4040lm
/200/XW 2700K	LED 36W	3780lm

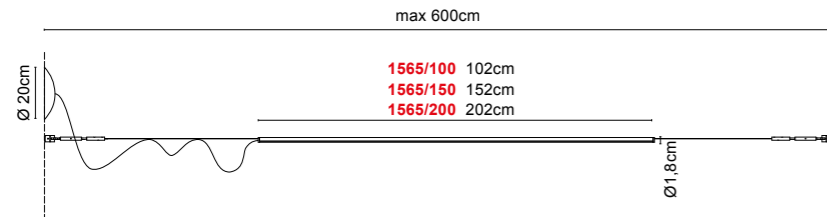

1565
Lancia Cavo completa di rosone e cavo di alimentazione.
Lancia Cavo complete with ceiling rose and power cable.

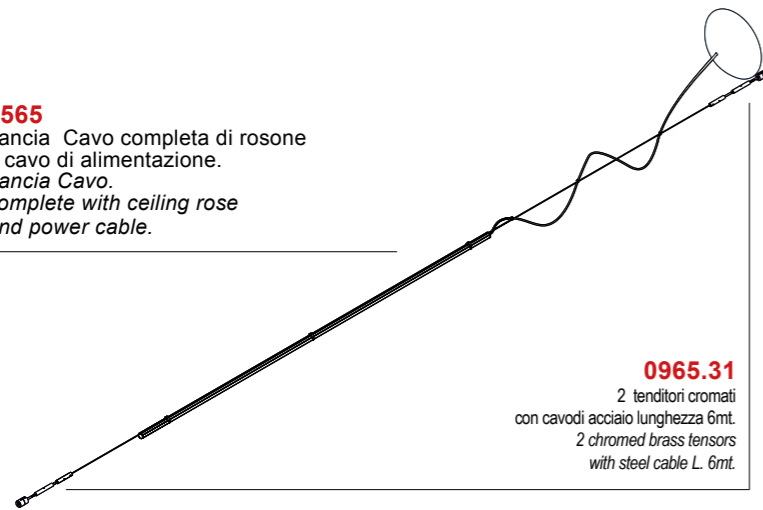

0965.31
2 tenditori cromati con cavodi acciaio lunghezza 6mt.
2 chromed brass tensors with steel cable L. 6mt.

Accessori - Accessories



0965.31
Coppia di tenditori cromati con cavo di acciaio lunghezza 6mt.
2 chromed brass tensors with steel cable L. 6mt.



Il profilo può ruotare sul suo asse di 360° per orientare la luce.
The profile can rotate on its axis of 360° to direct the light.

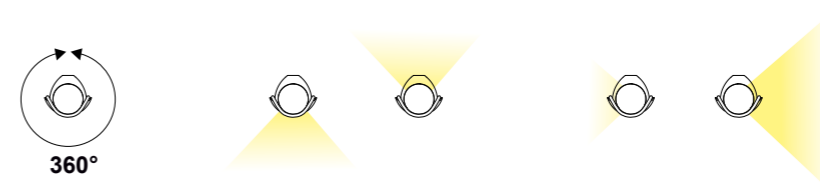

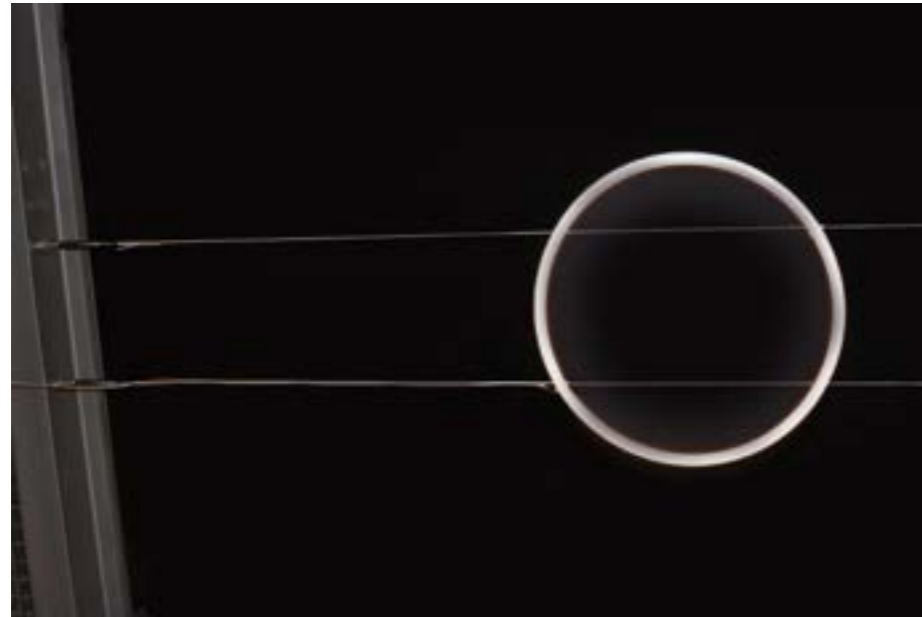

1171 Lancia Tonda Cavo Ø 35cm
 .01 Bianco - White
 .02 Nero - Black
 .25 Ottone satinato - Satin brass
 .31 Cromato - Chromed

Color temperature	Light sources	lm
/W 4000K	LED 18W	2260lm
/WW 3000K	LED 18W	2020lm
/XW 2700K	LED 18W	1890lm

0,80 Kg

1172 Lancia Tonda Cavo Ø 50cm
 .01 Bianco - White
 .02 Nero - Black
 .25 Ottone satinato - Satin brass
 .31 Cromato - Chromed

Color temperature	Light sources	lm
/W 4000K	LED 27W	3390lm
/WW 3000K	LED 27W	3030lm
/XW 2700K	LED 27W	2835lm

1,00 Kg

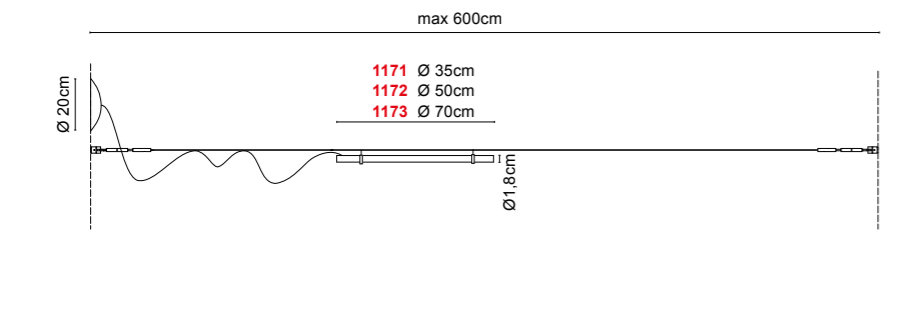

1173 Lancia Tonda Cavo Ø 70cm
 .01 Bianco - White
 .02 Nero - Black
 .25 Ottone satinato - Satin brass
 .31 Cromato - Chromed

Color temperature	Light sources	lm
/W 4000K	LED 37,5W	4633lm
/WW 3000K	LED 37,5W	4141lm
/XW 2700K	LED 37,5W	3874lm

1,20 Kg

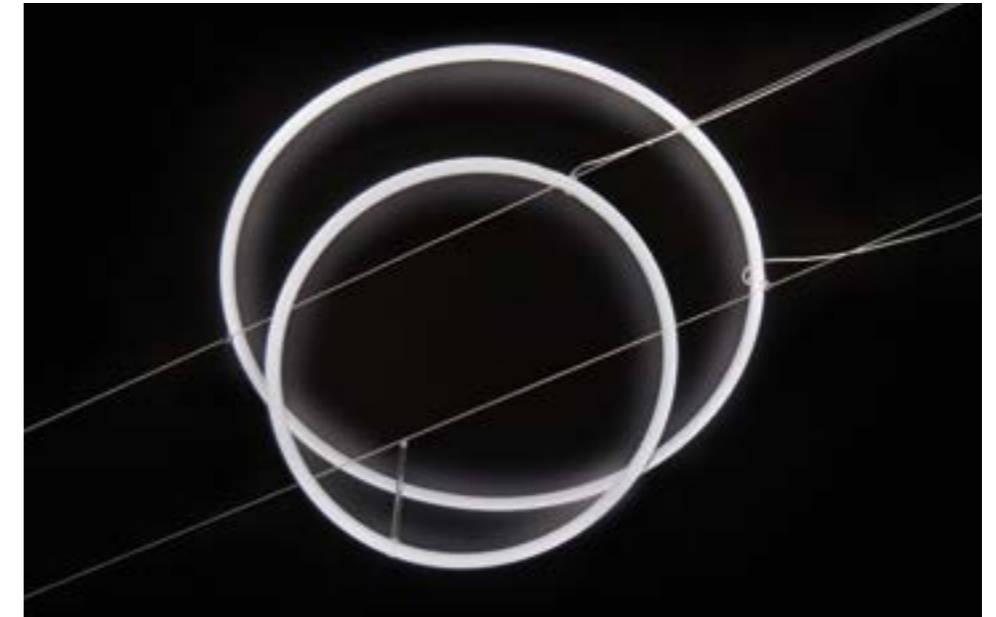

1172
 Lancia Tonda Cavo Ø 50cm
 completa di rosone
 e cavo di alimentazione L. 5,5mt.
 Lancia Tonda Cavo Ø 50cm
 complete with ceiling rose
 and power cable 5.5mt.

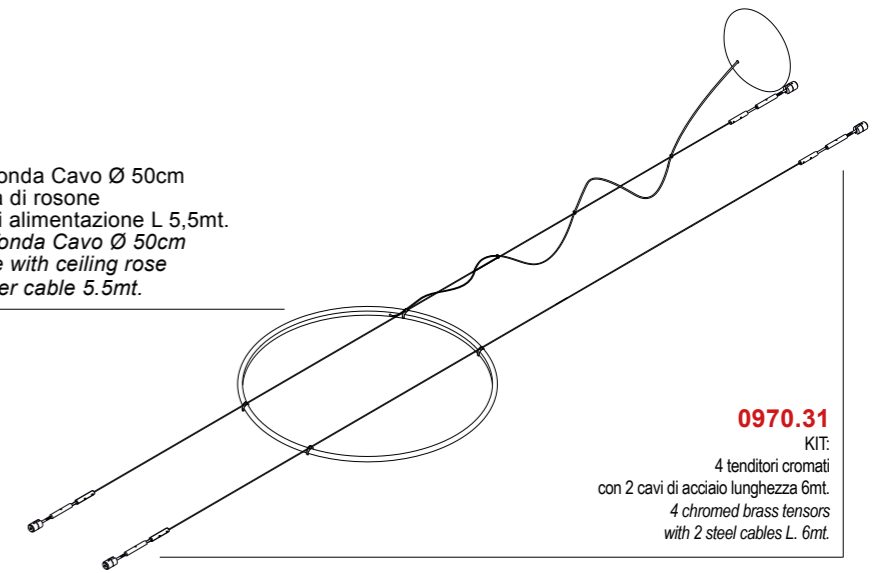

0970.31
 KIT:
 4 tenditori cromati
 con 2 cavi di acciaio lunghezza 6mt.
 4 chromed brass tensors
 with 2 steel cables L. 6mt.

Accessori - Accessories



0970.31
 KIT:
 4 tenditori cromati
 con 2 cavi di acciaio lunghezza 6mt.
 4 chromed brass tensors
 with 2 steel cables L. 6mt.

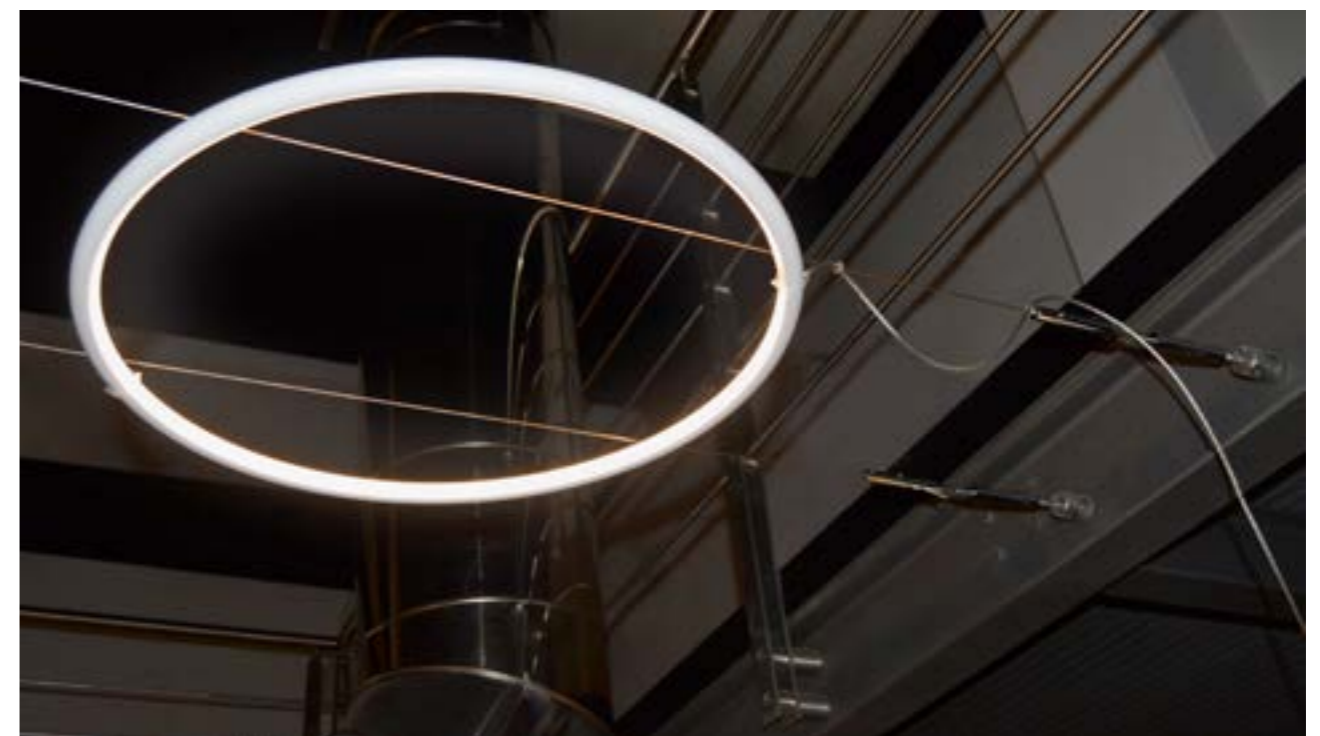

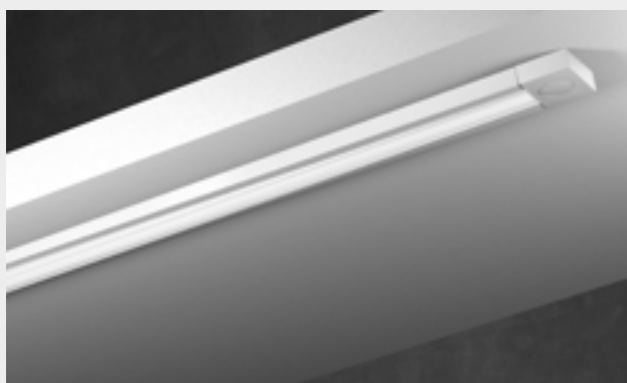

Barres linéaires pour lumière LED en aluminium extrudé anodisé avec diffuseurs en polycarbonate opale pour applications en applique, plafond ou encastrées.

Bouchons de fermeture, en ABS peint. Disponible en différentes tailles (voir tableaux), trois températures de couleur (2700, 3000 et 4000K) et versions RVB.

LED CRI> 90, 180 LED/mètre (15W ou 18W) ou 120 LED/mètre (9,6W), 3 SDCM.

Barras lineales para luz LED en aluminio anodizado extruido con difusores de policarbonato opal para aplicaciones sobre pared, techo o empotradas.

Tapones de cierre, en ABS pintado. Disponible en diferentes tamaños (ver tablas), tres temperaturas de color de la luz (2700, 3000 y 4000K) y versiones RGB.

LED CRI> 90, 180 LED / metro (15W o 18W) o 120 LED / metro (9,6W), 3 SDCM.

Lineare LED-Lichtleisten aus stranggepresstem, eloxiertem Aluminium mit Diffusoren aus opalem Polycarbonat für Wall oder Decken oder Einbauanwendungen.

Verschlusskappen aus lackiertem ABS. Erhältlich in verschiedenen Größen (siehe Tabellen), drei Lichtfarbtemperaturen (2700, 3000 und 4000K) und RGB-Versionen.

CRI-LEDs> 90, 180 LEDs / Meter (15 W oder 18 W) oder 120 LEDs / Meter (9,6 W), 3 SDCM.

Линейные линейки для светодиодного освещения из экструдированного анодированного алюминия с рассеивателями из поликарбоната опала для наружных или встраиваемых систем

Закрывающиеся крышки, окрашенные в серый цвет АБС. Доступны разные размеры (см. Таблицы), три варианта цветовой температуры (2700, 3000 и 4000K) и версии RGB.

Светодиоды CRI> 90, 180 светодиодов / метр (15 Вт или 18 Вт) или 120 светодиодов / метр (9,6 Вт), 3 СДКМ.

PROFILI

design: U.T. EGOLUCE

Barre lineari per luce LED in estruso d'alluminio anodizzato con diffusori in policarbonato opalino per applicazioni su parete, soffitto o ad incasso. Tappi di chiusura, in ABS verniciato. Disponibili in diverse misure (vedi tabelle), tre temperature di colore della luce (2700, 3000 e 4000K) e versioni RGB.

LED CRI>90, 180 LED/metro (15W o 18W) o 120 LED/metro (9,6W), 3 SDCM.

Linear profiles for LED light in extruded anodized aluminum with opal polycarbonate diffusers for wall, ceiling or recessed applications.

Closing caps, in painted ABS. Available in different sizes (see tables), three light color temperatures (2700, 3000 and 4000K) and RGB versions.

CRI LEDs> 90, 180 LED/meter (15W or 18W) or 120 LED/meter (9.6W /), 3 SDCM.

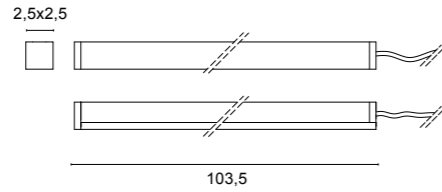

4521 Extra
.01 Bianco - White

Color temperature	Light sources	lm
/W 4000K	LED 15W	1840lm
/WW 3000K	LED 15W	1650lm
/XW 2700K	LED 15W	1560lm

0,15Kg

Versione ETL disponibile a richiesta.
 ETL version available upon request.

Pixeling free

Il nuovo circuito 180 LED/mt. annulla l'effetto puntiforme garantendo una luce continua e uniforme.

New LED strip 180 LED /mt. cancels the pixeling effect guaranteeing a continuous and uniform light.

CUSTOM SIZE

Tabella lunghezze disponibili a richiesta. - Table of available lengths on request.

cm.	watt	2700K (XW)	lm	3000K (WW)	lm	4000K (W)	lm
13,5	1,5W	A4521.01/10/XW	156	A4521.01/10/WW	165	A4521.01/10/W	184
23,5	3W	A4521.01/20/XW	312	A4521.01/20/WW	330	A4521.01/20/W	368
33,5	4,5W	A4521.01/30/XW	468	A4521.01/30/WW	495	A4521.01/30/W	552
43,5	6W	A4521.01/40/XW	624	A4521.01/40/WW	660	A4521.01/40/W	736
53,5	7,5W	A4521.01/50/XW	780	A4521.01/50/WW	825	A4521.01/50/W	920
63,5	9W	A4521.01/60/XW	936	A4521.01/60/WW	990	A4521.01/60/W	1104
73,5	10,5W	A4521.01/70/XW	1092	A4521.01/70/WW	1155	A4521.01/70/W	1288
83,5	12W	A4521.01/80/XW	1248	A4521.01/80/WW	1320	A4521.01/80/W	1472
93,5	13,5W	A4521.01/90/XW	1404	A4521.01/90/WW	1485	A4521.01/90/W	1656
* 103,5	15W	4521.01/XW	1560	4521.01/WW	1650	4521.01/W	1840
113,5	16,5W	A4521.01/110/XW	1716	A4521.01/110/WW	1815	A4521.01/110/W	2024
123,5	18W	A4521.01/120/XW	1872	A4521.01/120/WW	1980	A4521.01/120/W	2208
133,5	19,5W	A4521.01/130/XW	2028	A4521.01/130/WW	2145	A4521.01/130/W	2392
143,5	21W	A4521.01/140/XW	2184	A4521.01/140/WW	2310	A4521.01/140/W	2576
153,5	22,5W	A4521.01/150/XW	2340	A4521.01/150/WW	2475	A4521.01/150/W	2760
163,5	24W	A4521.01/160/XW	2496	A4521.01/160/WW	2640	A4521.01/160/W	2944
173,5	25,5W	A4521.01/170/XW	2652	A4521.01/170/WW	2805	A4521.01/170/W	3128
183,5	27W	A4521.01/180/XW	2808	A4521.01/180/WW	2970	A4521.01/180/W	3312
193,5	28,5W	A4521.01/190/XW	2964	A4521.01/190/WW	3135	A4521.01/190/W	3496
203,5	30W	A4521.01/200/XW	3120	A4521.01/200/WW	3300	A4521.01/200/W	3680
213,5	31,5W	A4521.01/210/XW	3276	A4521.01/210/WW	3465	A4521.01/210/W	3864
223,5	33W	A4521.01/220/XW	3432	A4521.01/220/WW	3630	A4521.01/220/W	4048
233,5	34,5W	A4521.01/230/XW	3588	A4521.01/230/WW	3795	A4521.01/230/W	4232
243,5	36W	A4521.01/240/XW	3744	A4521.01/240/WW	3960	A4521.01/240/W	4416
253,5	37,5W	A4521.01/250/XW	3900	A4521.01/250/WW	4125	A4521.01/250/W	4600
263,5	39W	A4521.01/260/XW	4056	A4521.01/260/WW	4290	A4521.01/260/W	4784
273,5	40,5W	A4521.01/270/XW	4212	A4521.01/270/WW	4455	A4521.01/270/W	4968
283,5	42W	A4521.01/280/XW	4368	A4521.01/280/WW	4620	A4521.01/280/W	5152
293,5	43,5W	A4521.01/290/XW	4524	A4521.01/290/WW	4785	A4521.01/290/W	5336
303,5	45W	A4521.01/300/XW	4680	A4521.01/300/WW	4950	A4521.01/300/W	5520

* Articolo standard a catalogo - Standard catalogue item



Lighting system



Lighting system

Drivers **ON/OFF**

Cod.	0155	0156	0160	0157	0161/100	0162
	24V-13W	24V-25W	24V-50W	24V-75W	24V-100W	24V-150W

DIMMABLE drivers

Cod.	0110/DIM	0717/DIM60	0717/DIM100
	12/24V	24V-60W	24V-100W

LED emergency unit

Cod.	0115/EM
	Inverter + Battery + LED indicator

Solo collegamento in parallelo. - Only parallel connection.

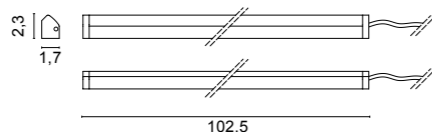

4520 Margo
.45 Alluminio anodizzato
 Aluminium anodized

Color temperature	Light sources	lm
/W 4000K	LED 15W	1840lm
/WW 3000K	LED 15W	1650lm
/XW 2700K	LED 15W	1560lm

0,15 Kg
 Versione ETL disponibile a richiesta.
 ETL version available upon request.

Pixeling free

Il nuovo circuito 180 LED/mt. annulla l'effetto puntiforme garantendo una luce continua e uniforme.

New LED strip 180 LED /mt. cancels the pixeling effect guaranteeing a continuous and uniform light.



Optional



0131/S
 Interruttore dimmer touch a richiesta. La lunghezza della lampada rimane invariata, l'interruttore riduce di 10cm la linea di luce.
 Touch dimmer switch on request. The lamp length don't change, touch switch reduces 10cm the light line.



0131/RV
 Sensore di presenza a richiesta. La lunghezza della lampada rimane invariata, il sensore riduce di 10cm la linea di luce.
 Body detector on request. The lamp length don't change, body detector reduces 10cm the light line.

CUSTOM SIZE

Tabella lunghezze disponibili. Le misure si riferiscono alle lunghezze totali delle lampade complete di tappi.
 Table of available lengths. Measures are referred to complete fixtures including closing heads.

cm.	watt	2700K (XW)	lm	3000K (WW)	lm	4000K (W)	lm	RGB
12,5	1,5W	A4520.45/10/XW	156	A4520.45/10/WW	165	A4520.45/10/W	184	A4520.45/10RGB
22,5	3W	A4520.45/20/XW	312	A4520.45/20/WW	330	A4520.45/20/W	368	A4520.45/20RGB
32,5	4,5W	A4520.45/30/XW	468	A4520.45/30/WW	495	A4520.45/30/W	552	A4520.45/30RGB
42,5	6W	A4520.45/40/XW	624	A4520.45/40/WW	660	A4520.45/40/W	736	A4520.45/40RGB
52,5	7,5W	A4520.45/50/XW	780	A4520.45/50/WW	825	A4520.45/50/W	920	A4520.45/50RGB
62,5	9W	A4520.45/60/XW	936	A4520.45/60/WW	990	A4520.45/60/W	1104	A4520.45/60RGB
72,5	10,5W	A4520.45/70/XW	1092	A4520.45/70/WW	1155	A4520.45/70/W	1288	A4520.45/70RGB
82,5	12W	A4520.45/80/XW	1248	A4520.45/80/WW	1320	A4520.45/80/W	1472	A4520.45/80RGB
92,5	13,5W	A4520.45/90/XW	1404	A4520.45/90/WW	1485	A4520.45/90/W	1656	A4520.45/90RGB
* 102,5	15W	4520.45/XW	1560	4520.45/WW	1650	4520.45/W	1840	A4520.45/100RGB
112,5	16,5W	A4520.45/110/XW	1716	A4520.45/110/WW	1815	A4520.45/110/W	2024	A4520.45/110RGB
122,5	18W	A4520.45/120/XW	1872	A4520.45/120/WW	1980	A4520.45/120/W	2208	A4520.45/120RGB
132,5	19,5W	A4520.45/130/XW	2028	A4520.45/130/WW	2145	A4520.45/130/W	2392	A4520.45/130RGB
142,5	21W	A4520.45/140/XW	2184	A4520.45/140/WW	2310	A4520.45/140/W	2576	A4520.45/140RGB
152,5	22,5W	A4520.45/150/XW	2340	A4520.45/150/WW	2475	A4520.45/150/W	2760	A4520.45/150RGB
162,5	24W	A4520.45/160/XW	2496	A4520.45/160/WW	2640	A4520.45/160/W	2944	A4520.45/160RGB
172,5	25,5W	A4520.45/170/XW	2652	A4520.45/170/WW	2805	A4520.45/170/W	3128	A4520.45/170RGB
182,5	27W	A4520.45/180/XW	2808	A4520.45/180/WW	2970	A4520.45/180/W	3312	A4520.45/180RGB
192,5	28,5W	A4520.45/190/XW	2964	A4520.45/190/WW	3135	A4520.45/190/W	3496	A4520.45/190RGB
202,5	30W	A4520.45/200/XW	3120	A4520.45/200/WW	3300	A4520.45/200/W	3680	A4520.45/200RGB
212,5	31,5W	A4520.45/210/XW	3276	A4520.45/210/WW	3465	A4520.45/210/W	3864	A4520.45/210RGB
222,5	33W	A4520.45/220/XW	3432	A4520.45/220/WW	3630	A4520.45/220/W	4048	A4520.45/220RGB
232,5	34,5W	A4520.45/230/XW	3588	A4520.45/230/WW	3795	A4520.45/230/W	4232	A4520.45/230RGB
242,5	36W	A4520.45/240/XW	3744	A4520.45/240/WW	3960	A4520.45/240/W	4416	A4520.45/240RGB
252,5	37,5W	A4520.45/250/XW	3900	A4520.45/250/WW	4125	A4520.45/250/W	4600	A4520.45/250RGB
262,5	39W	A4520.45/260/XW	4056	A4520.45/260/WW	4290	A4520.45/260/W	4784	A4520.45/260RGB
272,5	40,5W	A4520.45/270/XW	4212	A4520.45/270/WW	4455	A4520.45/270/W	4968	A4520.45/270RGB
282,5	42W	A4520.45/280/XW	4368	A4520.45/280/WW	4620	A4520.45/280/W	5152	A4520.45/280RGB
292,5	43,5W	A4520.45/290/XW	4524	A4520.45/290/WW	4785	A4520.45/290/W	5336	A4520.45/290RGB
302,5	45W	A4520.45/300/XW	4680	A4520.45/300/WW	4950	A4520.45/300/W	5520	A4520.45/300RGB

* Articolo standard a catalogo - Standard catalogue item

Drivers ON/OFF

Cod.	0155	0156	0160	0157	0161/100	0162
	24V-13W	24V-25W	24V-50W	24V-75W	24V-100W	24V-150W

DIMMABLE drivers

Cod.	0110/DIM	0717/DIM60	0717/DIM100
	12/24V	24V-60W	24V-100W

LED emergency unit

Cod.	0115/EM
	Inverter + Battery + LED indicator

RGB drivers

Cod.	0164	0167	Driver RGB Casambi	0163	0165	0166
	120W	22W	0164/CASA 120W	IR Sensor	IR Remote controller	Sinc Cable
	IN:230V - OUT: 3x24V		IN:230V - OUT: 3x24V			

Solo collegamento in parallelo. - Only parallel connection.

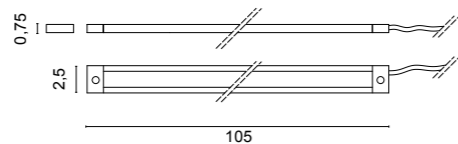

4515 Plana
 .01 Bianco - White
 .45 Alluminio anodizzato
 Aluminium anodized

Color temperature	Light sources	lm
/W 4000K	LED 9,6W	1080lm
/WW 3000K	LED 9,6W	1020lm
/XW 2700K	LED 9,6W	960lm

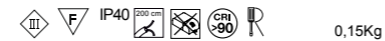

Versione ETL disponibile a richiesta.
 ETL version available upon request.

0,15Kg



Lighting system

Optional

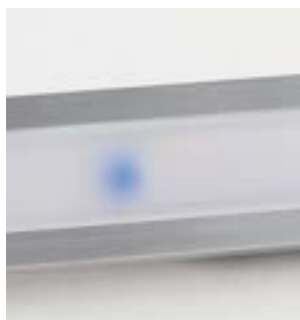

0131/S

Interruttore dimmer touch a richiesta.
 La lunghezza della lampada rimane invariata, l'interruttore riduce di 10cm la linea di luce.

Touch dimmer switch on request.
 The lamp length don't change, touch switch reduces 10cm the light line.

CUSTOM SIZE

Tabella lunghezze disponibili. Le misure si riferiscono alle lunghezze totali delle lampade complete di tappi.
 Table of available lengths. Measures are referred to complete fixtures including closing heads.

cm.	watt	2700K (XW)	lm	3000K (WW)	lm	4000K (W)	lm
15	1W	A4515 * /10/XW	96	A4515 * /10/WW	102	A4515 * /10/W	108
25	1,9W	A4515 * /20/XW	192	A4515 * /20/WW	204	A4515 * /20/W	216
35	2,9W	A4515 * /30/XW	288	A4515 * /30/WW	306	A4515 * /30/W	324
45	3,8W	A4515 * /40/XW	384	A4515 * /40/WW	408	A4515 * /40/W	432
55	4,8W	A4515 * /50/XW	480	A4515 * /50/WW	510	A4515 * /50/W	540
65	5,8W	A4515 * /60/XW	576	A4515 * /60/WW	612	A4515 * /60/W	648
75	6,7W	A4515 * /70/XW	672	A4515 * /70/WW	714	A4515 * /70/W	756
85	7,7W	A4515 * /80/XW	768	A4515 * /80/WW	816	A4515 * /80/W	864
95	8,6W	A4515 * /90/XW	864	A4515 * /90/WW	918	A4515 * /90/W	972
105 **	9,6W	4515 * /XW	960	4515 * /WW	1020	4515 * /W	1080
115	10,6W	A4515 * /110/XW	1056	A4515 * /110/WW	1122	A4515 * /110/W	1188
125	11,5W	A4515 * /120/XW	1152	A4515 * /120/WW	1224	A4515 * /120/W	1296
135	12,5W	A4515 * /130/XW	1248	A4515 * /130/WW	1326	A4515 * /130/W	1404
145	13,4W	A4515 * /140/XW	1344	A4515 * /140/WW	1428	A4515 * /140/W	1512
155	14,4W	A4515 * /150/XW	1440	A4515 * /150/WW	1530	A4515 * /150/W	1620
165	15,4W	A4515 * /160/XW	1536	A4515 * /160/WW	1632	A4515 * /160/W	1728
175	16,3W	A4515 * /170/XW	1632	A4515 * /170/WW	1734	A4515 * /170/W	1836
185	17,3W	A4515 * /180/XW	1728	A4515 * /180/WW	1836	A4515 * /180/W	1944
195	18,2W	A4515 * /190/XW	1824	A4515 * /190/WW	1938	A4515 * /190/W	2052
205	19,2W	A4515 * /200/XW	1920	A4515 * /200/WW	2040	A4515 * /200/W	2160
215	20,2W	A4515 * /210/XW	2016	A4515 * /210/WW	2142	A4515 * /210/W	2268
225	21,1W	A4515 * /220/XW	2112	A4515 * /220/WW	2244	A4515 * /220/W	2376
235	22,1W	A4515 * /230/XW	2208	A4515 * /230/WW	2346	A4515 * /230/W	2484
245	23W	A4515 * /240/XW	2304	A4515 * /240/WW	2448	A4515 * /240/W	2592
255	24W	A4515 * /250/XW	2400	A4515 * /250/WW	2550	A4515 * /250/W	2700
265	25W	A4515 * /260/XW	2496	A4515 * /260/WW	2652	A4515 * /260/W	2808
275	25,9W	A4515 * /270/XW	2592	A4515 * /270/WW	2754	A4515 * /270/W	2916
285	26,9W	A4515 * /280/XW	2688	A4515 * /280/WW	2856	A4515 * /280/W	3024
295	27,8W	A4515 * /290/XW	2784	A4515 * /290/WW	2958	A4515 * /290/W	3132
305	28,8W	A4515 * /300/XW	2880	A4515 * /300/WW	3060	A4515 * /300/W	3240

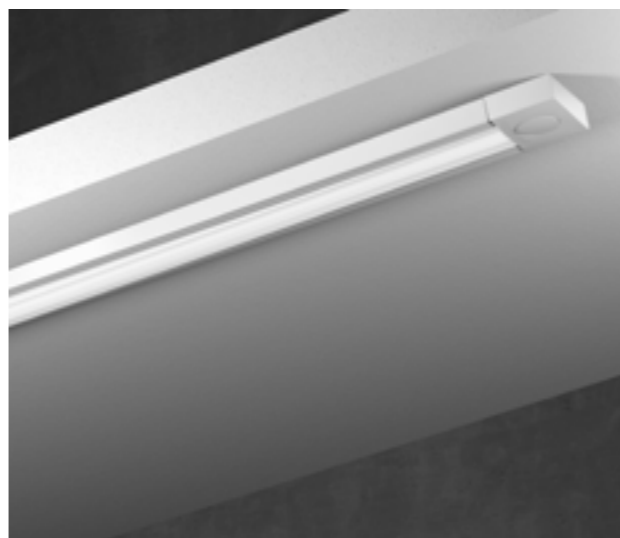

* Finiture - Finishes:
 .01 Bianco - White
 .45 Alluminio anodizzato - Aluminium anodized

** Articolo standard a catalogo - Standard catalogue item

Drivers ON/OFF

Cod.	0155	0156	0160	0157	0161/100	0162
	24V-13W	24V-25W	24V-50W	24V-75W	24V-100W	24V-150W

DIMMABLE drivers

Cod.	0110/DIM	0717/DIM60	0717/DIM100
	12/24V	24V-60W	24V-100W

LED emergency unit

Cod.	0115/EM
	Inverter + Battery + LED indicator

Solo collegamento in parallelo. - Only parallel connection.

Lighting system

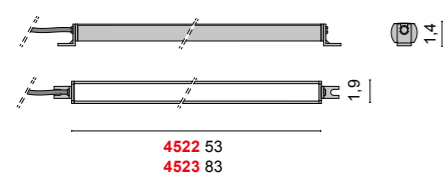

4522 Magika
 .45 Alluminio anodizzato
 Aluminium anodized

Color temperature	Light sources	lm
/W 4000K	LED 7.5W	920lm
/WW 3000K	LED 7.5W	825m
/XW 2700K	LED 7.5W	780lm



Versione ETL disponibile a richiesta.
 ETL version available upon request.

4523 Magika
 .45 Alluminio anodizzato
 Aluminium anodized

Color temperature	Light sources	lm
/W 4000K	LED 12W	1472lm
/WW 3000K	LED 12W	1320m
/XW 2700K	LED 12W	1248lm



Versione ETL disponibile a richiesta.
 ETL version available upon request.

Pixeling free

Il nuovo circuito 180 LED/mt. annulla l'effetto puntiforme garantendo una luce continua e uniforme.

New LED strip 180 LED /mt. cancels the pixeling effect guaranteeing a continuous and uniform light.



CUSTOM SIZE

Tabella lunghezze disponibili. Le misure si riferiscono alle lunghezze totali delle lampade senza squadrette orientabili.
 Per montaggio con squadrette orientabili aggiungere 2 cm.
 Table of available lengths. Measures are referred to complete fixtures excluding fixing supports
 To install using fixing supports add 2 cm more.

cm.	watt	2700K (XW)	lm	3000K (WW)	lm	4000K (W)	lm	RGB
13	1,5W	A4522.45/10/XW	156	A4522.45/10/WW	165	A4522.45/10/W	184	A4522.45/10RGB
23	3W	A4522.45/20/XW	312	A4522.45/20/WW	330	A4522.45/20/W	368	A4522.45/20RGB
33	4,5W	A4522.45/30/XW	468	A4522.45/30/WW	495	A4522.45/30/W	552	A4522.45/30RGB
43	6W	A4522.45/40/XW	624	A4522.45/40/WW	660	A4522.45/40/W	736	A4522.45/40RGB
53**	7,5W	4522.45/XW	780	4522.45/WW	825	4522.45/W	920	A4522.45/50RGB
63	9W	A4522.45/60/XW	936	A4522.45/60/WW	990	A4522.45/60/W	1104	A4522.45/60RGB
73	10,5W	A4522.45/70/XW	1092	A4522.45/70/WW	1155	A4522.45/70/W	1288	A4522.45/70RGB
83**	12W	4523.45/XW	1248	4523.45/WW	1320	4523.45/W	1472	A4522.45/80RGB
93	13,5W	A4522.45/90/XW	1404	A4522.45/90/WW	1485	A4522.45/90/W	1656	A4522.45/90RGB
103	15W	A4522.45/100/XW	1560	A4522.45/100/WW	1650	A4522.45/100/W	1840	A4522.45/100RGB
113	16,5W	A4522.45/110/XW	1716	A4522.45/110/WW	1815	A4522.45/110/W	2024	A4522.45/110RGB
123	18W	A4522.45/120/XW	1872	A4522.45/120/WW	1980	A4522.45/120/W	2208	A4522.45/120RGB
133	19,5W	A4522.45/130/XW	2028	A4522.45/130/WW	2145	A4522.45/130/W	2392	A4522.45/130RGB
143	21W	A4522.45/140/XW	2184	A4522.45/140/WW	2310	A4522.45/140/W	2576	A4522.45/140RGB
153	22,5W	A4522.45/150/XW	2340	A4522.45/150/WW	2475	A4522.45/150/W	2760	A4522.45/150RGB
163	24W	A4522.45/160/XW	2496	A4522.45/160/WW	2640	A4522.45/160/W	2944	A4522.45/160RGB
173	25,5W	A4522.45/170/XW	2652	A4522.45/170/WW	2805	A4522.45/170/W	3128	A4522.45/170RGB
183	27W	A4522.45/180/XW	2808	A4522.45/180/WW	2970	A4522.45/180/W	3312	A4522.45/180RGB
193	28,5W	A4522.45/190/XW	2964	A4522.45/190/WW	3135	A4522.45/190/W	3496	A4522.45/190RGB
203	30W	A4522.45/200/XW	3120	A4522.45/200/WW	3300	A4522.45/200/W	3680	A4522.45/200RGB
213	31,5W	A4522.45/210/XW	3276	A4522.45/210/WW	3465	A4522.45/210/W	3864	A4522.45/210RGB
223	33W	A4522.45/220/XW	3432	A4522.45/220/WW	3630	A4522.45/220/W	4048	A4522.45/220RGB
233	34,5W	A4522.45/230/XW	3588	A4522.45/230/WW	3795	A4522.45/230/W	4232	A4522.45/230RGB
243	36W	A4522.45/240/XW	3744	A4522.45/240/WW	3960	A4522.45/240/W	4416	A4522.45/240RGB
253	37,5W	A4522.45/250/XW	3900	A4522.45/250/WW	4125	A4522.45/250/W	4600	A4522.45/250RGB
263	39W	A4522.45/260/XW	4056	A4522.45/260/WW	4290	A4522.45/260/W	4784	A4522.45/260RGB
273	40,5W	A4522.45/270/XW	4212	A4522.45/270/WW	4455	A4522.45/270/W	4968	A4522.45/270RGB
283	42W	A4522.45/280/XW	4368	A4522.45/280/WW	4620	A4522.45/280/W	5152	A4522.45/280RGB
293	43,5W	A4522.45/290/XW	4524	A4522.45/290/WW	4785	A4522.45/290/W	5336	A4522.45/290RGB
303	45W	A4522.45/300/XW	4680	A4522.45/300/WW	4950	A4522.45/300/W	5520	A4522.45/300RGB

** Articolo standard a catalogo - Standard catalogue item



Optional



0131/S
 Interruttore dimmer touch a richiesta.
 La lunghezza della lampada rimane invariata, l'interruttore riduce di 10cm la linea di luce.

Touch dimmer switch on request.
 The lamp length don't change, touch switch reduces 10cm the light line.



0131/RV
 Sensore di presenza a richiesta. La lunghezza della lampada rimane invariata, il sensore riduce di 10cm la linea di luce.

Body detector on request.
 The lamp length don't change, body detector reduces 10cm the light line.

Drivers ON/OFF

Cod.	0155	0156	0160	0157	0161/100	0162
	24V-13W	24V-25W	24V-50W	24V-75W	24V-100W	24V-150W

DIMMABLE drivers

Cod.	0110/DIM	0717/DIM60	0717/DIM100
	12/24V	24V-60W	24V-100W

LED emergency unit

Cod.	0115/EM
	Inverter + Battery + LED indicator

RGB drivers

Cod.	0164	0167	Driver RGB Casambi
	120W	22W	0164/CASA
	IN:230V - OUT: 3x24V		120W
			IN:230V - OUT: 3x24V

0163	0165	0166
IR Sensor	IR Remote controller	Sinc Cable

Solo collegamento in parallelo. - Only parallel connection.

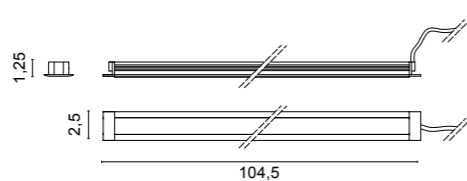

6661 Into

.01	Bianco - White	
.45	Alluminio anodizzato Aluminium anodized	

Color temperature	Light sources	lm
/W	4000K LED 9,6W	1080lm
/WW	3000K LED 9,6W	1020m
/XW	2700K LED 9,6W	960lm

0,20Kg

Versione **ETL** disponibile a richiesta.
ETL version available upon request.

1,8x 103,5 cm.



CUSTOM SIZE

Tabella lunghezze disponibili. Le misure si riferiscono alle lunghezze totali delle lampade complete di tappi.
Table of available lengths. Measures are referred to complete fixtures including closing heads.

cm.	watt	cm.	2700K (XW)	lm	3000K (WW)	lm	4000K (W)	lm
14,5	1W	13,5x1,8	A6661 * /10/XW	96	A6661 * /10/WW	102	A6661 * /10/W	108
24,5	1,9W	23,5x1,8	A6661 * /20/XW	192	A6661 * /20/WW	204	A6661 * /20/W	216
34,5	2,9W	33,5x1,8	A6661 * /30/XW	288	A6661 * /30/WW	306	A6661 * /30/W	324
44,5	3,8W	43,5x1,8	A6661 * /40/XW	384	A6661 * /40/WW	408	A6661 * /40/W	432
54,5	4,8W	53,5x1,8	A6661 * /50/XW	480	A6661 * /50/WW	510	A6661 * /50/W	540
64,5	5,8W	63,5x1,8	A6661 * /60/XW	576	A6661 * /60/WW	612	A6661 * /60/W	648
74,5	6,7W	73,5x1,8	A6661 * /70/XW	672	A6661 * /70/WW	714	A6661 * /70/W	756
84,5	7,7W	83,5x1,8	A6661 * /80/XW	768	A6661 * /80/WW	816	A6661 * /80/W	864
94,5	8,6W	93,5x1,8	A6661 * /90/XW	864	A6661 * /90/WW	918	A6661 * /90/W	972
104,5 **	9,6W	103,5x1,8	6661 * /XW	960	6661 * / WW	1020	6661 * /W	1080
114,5	10,6W	113,5x1,8	A6661 * /110/XW	1056	A6661 * /110/WW	1122	A6661 * /110/W	1188
124,5	11,5W	123,5x1,8	A6661 * /120/XW	1152	A6661 * /120/WW	1224	A6661 * /120/W	1296
134,5	12,5W	133,5x1,8	A6661 * /130/XW	1248	A6661 * /130/WW	1326	A6661 * /130/W	1404
144,5	13,4W	143,5x1,8	A6661 * /140/XW	1344	A6661 * /140/WW	1428	A6661 * /140/W	1512
154,5	14,4W	153,5x1,8	A6661 * /150/XW	1440	A6661 * /150/WW	1530	A6661 * /150/W	1620
164,5	15,4W	163,5x1,8	A6661 * /160/XW	1536	A6661 * /160/WW	1632	A6661 * /160/W	1728
174,5	16,3W	173,5x1,8	A6661 * /170/XW	1632	A6661 * /170/WW	1734	A6661 * /170/W	1836
184,5	17,3W	183,5x1,8	A6661 * /180/XW	1728	A6661 * /180/WW	1836	A6661 * /180/W	1944
194,5	18,2W	193,5x1,8	A6661 * /190/XW	1824	A6661 * /190/WW	1938	A6661 * /190/W	2052
204,5	19,2W	203,5x1,8	A6661 * /200/XW	1920	A6661 * /200/WW	2040	A6661 * /200/W	2160
214,5	20,2W	213,5x1,8	A6661 * /210/XW	2016	A6661 * /210/WW	2142	A6661 * /210/W	2268
224,5	21,1W	223,5x1,8	A6661 * /220/XW	2112	A6661 * /220/WW	2244	A6661 * /220/W	2376
234,5	22,1W	233,5x1,8	A6661 * /230/XW	2208	A6661 * /230/WW	2346	A6661 * /230/W	2484
244,5	23W	243,5x1,8	A6661 * /240/XW	2304	A6661 * /240/WW	2448	A6661 * /240/W	2592
254,5	24W	253,5x1,8	A6661 * /250/XW	2400	A6661 * /250/WW	2550	A6661 * /250/W	2700
264,5	25W	263,5x1,8	A6661 * /260/XW	2496	A6661 * /260/WW	2652	A6661 * /260/W	2808
274,5	25,9W	273,5x1,8	A6661 * /270/XW	2592	A6661 * /270/WW	2754	A6661 * /270/W	2916
284,5	26,9W	283,5x1,8	A6661 * /280/XW	2688	A6661 * /280/WW	2856	A6661 * /280/W	3024
294,5	27,8W	293,5x1,8	A6661 * /290/XW	2784	A6661 * /290/WW	2958	A6661 * /290/W	3132
304,5	28,8W	303,5x1,8	A6661 * /300/XW	2880	A6661 * /300/WW	3060	A6661 * /300/W	3240

* Finiture - Finishes:

- .01** Bianco - White
- .45** Alluminio anodizzato - Aluminium anodized

** Articolo standard a catalogo - Standard catalogue item



Optional



0131/S

Interruttore dimmer touch a richiesta. La lunghezza della lampada rimane invariata, l'interruttore riduce di 10cm la linea di luce.

Touch dimmer switch on request. The lamp length don't change, touch switch reduces 10cm the light line.



0131/RV

Sensore di presenza a richiesta. La lunghezza della lampada rimane invariata, il sensore riduce di 10cm la linea di luce.

Body detector on request. The lamp length don't change, body detector reduces 10cm the light line.

Drivers **ON/OFF**

Cod.	0155	0156	0160	0157	0161/100	0162
	24V-13W	24V-25W	24V-50W	24V-75W	24V-100W	24V-150W

DIMMABLE drivers

Cod.	0110/DIM	0717/DIM60	0717/DIM100
	12/24V	24V-60W	24V-100W

LED emergency unit

Cod.	0115/EM
	Inverter + Battery + LED indicator

Solo collegamento in parallelo. - Only parallel connection.

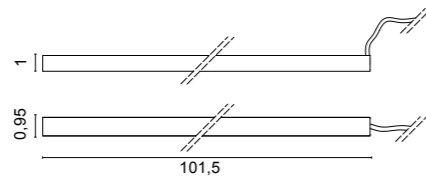

101,5 x 0,95cm.

6662 Woody

.45 Alluminio anodizzato
Aluminium anodized

Color temperature	Light sources	lm
/W 4000K	LED 11W	1640lm
/WW 3000K	LED 11W	1490lm
/XW 2700K	LED 11W	1390lm

IP40 0,10Kg

CUSTOM SIZE

Tabella lunghezze disponibili. Le misure si riferiscono alle lunghezze totali delle lampade complete di tappi.
Table of available lengths. Measures are referred to complete fixtures including closing heads.

cm.	watt	cm.	2700K (XW)	lm	3000K (WW)	lm	4000K (W)	lm
11,5	1,1W	11,5 x 0,95	A6662/10/XW	139	A6662/10/WW	149	A6662/10/W	164
21,5	2,2W	21,5 x 0,95	A6662/20/XW	278	A6662/20/WW	298	A6662/20/W	328
31,5	3,3W	31,5 x 0,95	A6662/30/XW	417	A6662/30/WW	447	A6662/30/W	492
41,5	4,4W	41,5 x 0,95	A6662/40/XW	556	A6662/40/WW	596	A6662/40/W	656
51,5	5,5W	51,5 x 0,95	A6662/50/XW	695	A6662/50/WW	745	A6662/50/W	820
61,5	6,6W	61,5 x 0,95	A6662/60/XW	834	A6662/60/WW	894	A6662/60/W	984
71,5	7,7W	71,5 x 0,95	A6662/70/XW	973	A6662/70/WW	1043	A6662/70/W	1148
81,5	8,8W	81,5 x 0,95	A6662/80/XW	1112	A6662/80/WW	1192	A6662/80/W	1312
91,5	9,9W	91,5 x 0,95	A6662/90/XW	1251	A6662/90/WW	1341	A6662/90/W	1476
101,5 *	11W	101,5 x 0,95	6662/XW	1390	6662/WW	1490	6662/W	1640
111,5	12,1W	111,5 x 0,95	A6662/110/XW	1529	A6662/110/WW	1609	A6662/110/W	1804
121,5	13,2W	121,5 x 0,95	A6662/120/XW	1668	A6662/120/WW	1768	A6662/120/W	1968
131,5	14,3W	131,5 x 0,95	A6662/130/XW	1807	A6662/130/WW	1927	A6662/130/W	2132
141,5	15,4W	141,5 x 0,95	A6662/140/XW	1946	A6662/140/WW	2086	A6662/140/W	2296
151,5	16,5W	151,5 x 0,95	A6662/150/XW	2085	A6662/150/WW	2245	A6662/150/W	2460
161,5	17,6W	161,5 x 0,95	A6662/160/XW	2224	A6662/160/WW	2404	A6662/160/W	2624
171,5	18,7W	171,5 x 0,95	A6662/170/XW	2363	A6662/170/WW	2563	A6662/170/W	2788
181,5	19,8W	181,5 x 0,95	A6662/180/XW	2502	A6662/180/WW	2722	A6662/180/W	2952
191,5	20,9W	191,5 x 0,95	A6662/190/XW	2641	A6662/190/WW	2881	A6662/190/W	3116
201,5	22W	201,5 x 0,95	A6662/200/XW	2780	A6662/200/WW	3040	A6662/200/W	3280

* Articolo standard a catalogo - Standard catalogue item



Lighting system

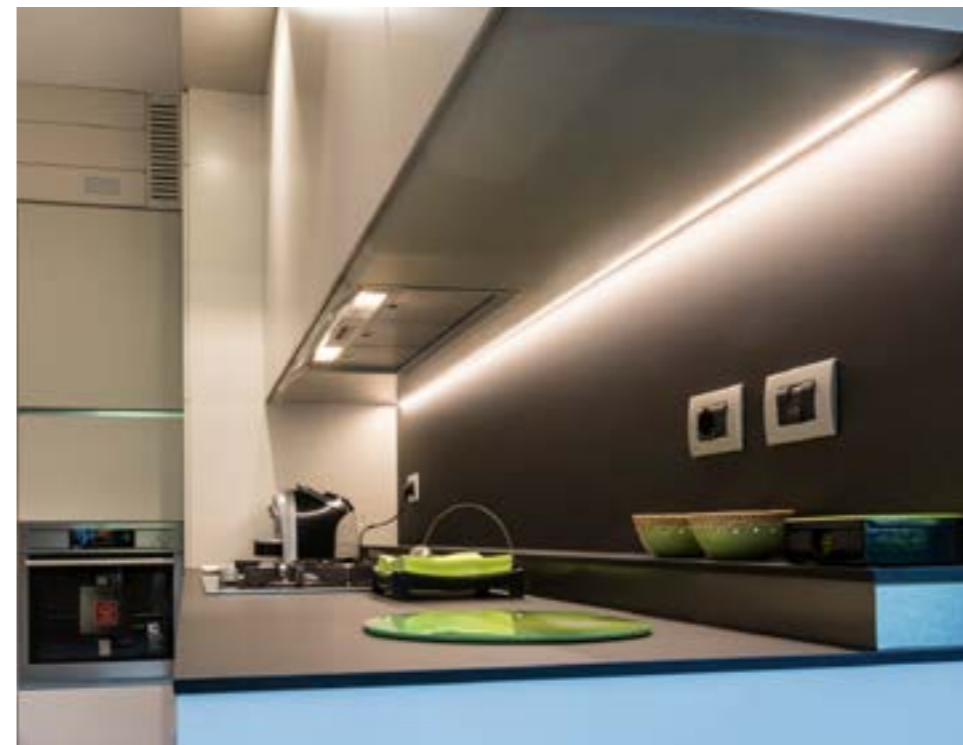

Lighting system

Drivers **ON/OFF**

Cod.	0155	0156	0160	0157	0161/100	0162
	24V-13W	24V-25W	24V-50W	24V-75W	24V-100W	24V-150W

DIMMABLE drivers

Cod.	0110/DIM	0717/DIM60	0717/DIM100
	12/24V	24V-60W	24V-100W

LED emergency unit

Cod.	0115/EM
	Inverter + Battery + LED indicator

Solo collegamento in parallelo. - Only parallel connection.



5511 Astra - 15W/mt - 5mt
.01 Bianco - White

Color temperature	Light sources	lm (5mt)
/W 4000K	LED 15W/mt.	9200lm
/WW 3000K	LED 15W/mt.	8250lm
/XW 2700K	LED 15W/mt.	7800lm



Nuova versione Strip LED:
15W/mt 180LED/mt CRI>90 3SDCM.
New version Strip LED:
15W/mt 180LED/mt CRI>90 3SDCM.

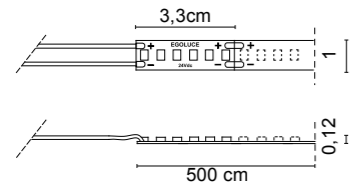

5552 Astra - 9,6W/mt - 5mt
.01 Bianco - White

Color temperature	Light sources	lm (5mt)
/W 4000K	LED 9,6W/mt.	5350lm
/WW 3000K	LED 9,6W/mt.	4700lm
/XW 2700K	LED 9,6W/mt.	4400lm



Nuova versione Strip LED:
9,6W/mt 120LED/mt CRI>90 3SDCM.
New version Strip LED:
9,6W/mt 120LED/mt CRI>90 3SDCM.

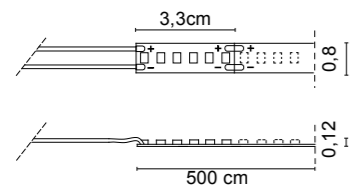

5553 Astra - 4,8W/mt - 5mt
.01 Bianco - White

Color temperature	Light sources	lm (5mt)
/W 4000K	LED 4,8W/mt.	2750lm
/WW 3000K	LED 4,8W/mt.	2450lm
/XW 2700K	LED 4,8W/mt.	2250lm



Nuova versione Strip LED:
4,8W/mt 120LED/mt CRI>90 3SDCM.
New version Strip LED:
4,8W/mt 120LED/mt CRI>90 3SDCM.

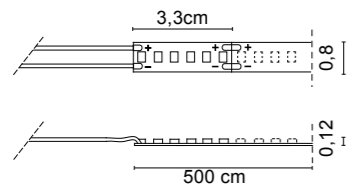

Accessori - Accessories

0881/FIX
Clip fissaggio profilo
Profile fixing clip

0244
Profilo in alluminio.
Aluminium profile.

/100	100cm
/200	200cm
/300	300cm

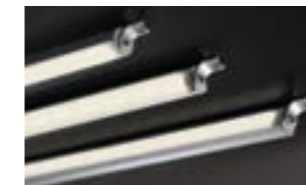

0244/T
Coppia di tappi con squadrette
per rotazione del profilo.
2 closing heads with brackets
for profile rotation

5511
Strip LED 15W/mt 180LED/mt CRI>90
5552
Strip LED 9,6W/mt 120LED/mt CRI>90.

0236
Diffusore in policarbonato opale.
Opal polycarbonate diffuser.

/100	100cm
/200	200cm
/300	300cm

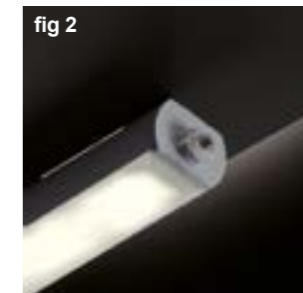

Il profilo può essere fissato con le squadrette fornite con i tappi (fig 1) o con le clips di fissaggio eliminando le squadrette (fig 2).

The profile can be fixed with the brackets supplied with the closing heads (fig 1) or with the fixing clips eliminating the brackets (fig 2).

0881/FIX
Clip fissaggio profilo
Profile fixing clip

0239
Profilo in alluminio.
Aluminium profile.

/100	100cm
/200	200cm
/300	300cm



0239/T
Coppia di tappi.
2 closing heads.

5511
Strip LED 15W/mt 180LED/mt CRI>90
5552
Strip LED 9,6W/mt 120LED/mt CRI>90.

0236
Diffusore in policarbonato opale.
Opal polycarbonate diffuser.

/100	100cm
/200	200cm
/300	300cm

Drivers ON/OFF

Cod.	0156	0160	0157	0161/100	0162
	24V-25W	24V-50W	24V-75W	24V-100W	24V-150W

DIMMABLE drivers

Cod.	0110/DIM	0717/DIM60	0717/DIM100
	12/24V	24V-60W	24V-100W

LED emergency unit

Cod.	0115/EM
	Inverter + Battery + LED indicator

	pag.
SNORKY	198
SNORKY MAKI	199
DOT TONDO	200
DOT QUADRO	200
DOT PLUS TONDO	201
DOT PLUS QUADRO	201
TRIM TONDO MONOEMISSIONE	202
TRIM QUADRO MONOEMISSIONE	202
TRIM TONDO BIEMISSIONE	202
TRIM QUADRO BIEMISSIONE	202
FIRE	204
FIRE RGB	205
SPOON TONDO	206
SPOON QUADRO	206
LUCCIOLA	208
LUCCIOLA RGB	209
ICE TONDO	210
ICE QUADRO	210
ICE QUADRO RGB	211
BYTE TONDO	212
BYTE QUADRO	212
SIRIO	214
VEGA	216
VEGA MAXI RGB	217
ALCOR	218
ALCOR MAXI RGB	219
TOP	220
TOP MINI	220
PIX TONDO	222
PIX QUADRO	222
PIX TONDO RGB	223
CERCHIETTO	224
CRUISE	224
SLOT	225



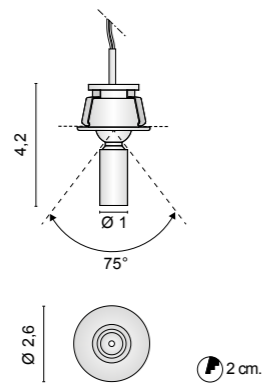

6373 Snorky
.31 Cromato - Chromed

Color temperature	Light sources	lm
/W 4000K	LED 1W 350mA	151lm
/WW 3000K	LED 1W 350mA	143lm
/XW 2700K	LED 1W 350mA	138lm

IP 40 0,02 Kg

Versione ETL disponibile a richiesta.
 ETL version available upon request.

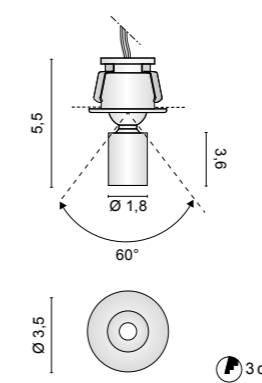

6313 Snorky Maxi
.01 Bianco - White
.02 Nero - Black
.31 Cromato - Chromed

Color temperature	Light sources	lm
/W 4000K	LED max 2W 500mA	209lm
/WW 3000K	LED max 2W 500mA	199lm
/XW 2700K	LED max 2W 500mA	189lm

IP 40 0,06 Kg

Versione ETL disponibile a richiesta.
 ETL version available upon request.



Decorative lights



Decorative lights

Accessori - Accessories



0212
 KIT: box + Plaster



0215
 Controcassa in materiale plastico
 Plastic box

Drivers ON/OFF		
Cod.	0125	0128
	350mA	350mA
6373	1-6	1-10

DIMMABLE drivers			
0141/DIM	0141/DALI	0145	0145/DALI
PUSH - 1...10V	DIM DALI	DIM	DIM DALI
1-12	1-12	1-21	1-21

DIMMABLE drivers Casambi	
0145/CASA	
1-21	

Solo collegamento in serie - Only serial connection

Accessori - Accessories



0213
 KIT: box + Plaster



0216
 Controcassa in materiale plastico
 Plastic box

Drivers ON/OFF			
Cod.	0125	0128	0127
	350mA	350mA	500mA
6313	1-6	1-10	1-6

DIMMABLE drivers			
0141/DIM	0141/DALI	0145/DALI	0145
PUSH - 1...10V	DIM DALI	DIM DALI	DIM
1-12	1-12	1-21	1-21

DIMMABLE drivers Casambi	
0145/CASA	
1-21	

Solo collegamento in serie - Only serial connection

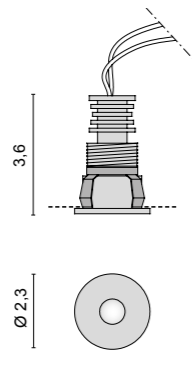

6320 Dot Tondo
 .01 Bianco - White
 .32 Nickel satinato - Nickel mat

Color temperature	Light sources	lm
/W	4000K LED 1W 350mA	151lm
/WW	3000K LED 1W 350mA	143lm
/XW	2700K LED 1W 350mA	138lm

IP 40 0,02 Kg

Versione ETL disponibile a richiesta.
 ETL version available upon request.

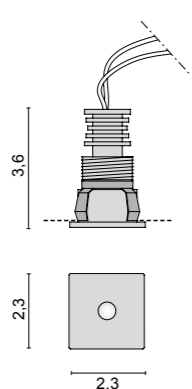

6321 Dot Quadro
 .01 Bianco - White
 .32 Nickel satinato - Nickel mat

Color temperature	Light sources	lm
/W	4000K LED 1W 350mA	151lm
/WW	3000K LED 1W 350mA	143lm
/XW	2700K LED 1W 350mA	138lm

IP 40 0,02 Kg

Versione ETL disponibile a richiesta.
 ETL version available upon request.

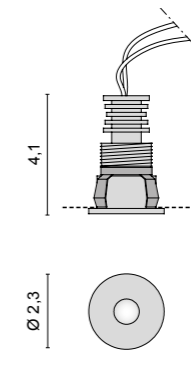

6316 Dot Plus Tondo
 .01 Bianco - White
 .32 Nickel satinato - Nickel mat

Color temperature	Light sources	lm
/W	4000K LED 1W 350mA	151lm
/WW	3000K LED 1W 350mA	143lm
/XW	2700K LED 1W 350mA	138lm

IP 44 0,02 Kg

Versione ETL disponibile a richiesta.
 ETL version available upon request.

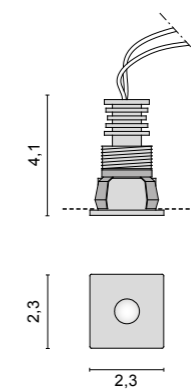

6317 Dot Plus Quadro
 .01 Bianco - White
 .32 Nickel satinato - Nickel mat

Color temperature	Light sources	lm
/W	4000K LED 1W 350mA	151lm
/WW	3000K LED 1W 350mA	143lm
/XW	2700K LED 1W 350mA	138lm

IP 44 0,02 Kg

Versione ETL disponibile a richiesta.
 ETL version available upon request.



Decorative lights

Decorative lights

Accessori - Accessories



0208
 Adattatore per doghe



0212
 KIT: box + Plaster



0215
 Controcassa in materiale plastico
 Plastic box

Drivers ON/OFF	
Cod.	350mA
6320	1-6
6321	1-6

DIMMABLE drivers			
0141/DIM	0141/DALI	0145	0145/DALI
PUSH - 1...10V	DIM DALI	DIM	DIM DALI
1-12	1-12	1-21	1-21
1-12	1-12	1-21	1-21

DIMMABLE drivers Casambi	
0145/CASA	
1-21	
1-21	

Solo collegamento in serie - Only serial connection

Accessori - Accessories



0212
 KIT: box + Plaster



0215
 Controcassa in materiale plastico
 Plastic box

Drivers ON/OFF	
Cod.	350mA
6316	1-6
6317	1-6

DIMMABLE drivers			
0141/DIM	0141/DALI	0145	0145/DALI
PUSH - 1...10V	DIM DALI	DIM	DIM DALI
1-12	1-12	1-21	1-21
1-12	1-12	1-21	1-21

DIMMABLE drivers Casambi	
0145/CASA	
1-21	
1-21	

Solo collegamento in serie - Only serial connection

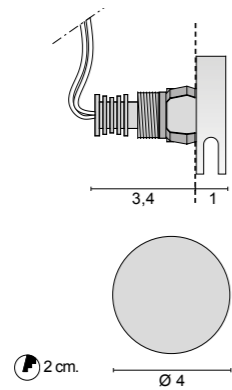

6338 Trim Tondo monoemissione
 .01 Bianco - White
 .45 Alluminio anodizzato
 Aluminium anodized

Color temperature Light sources lm
 /W 4000K LED max 2W 500mA 209lm
 /MW 3000K LED max2W 500mA 199lm

IP 40 0,03 Kg

Versione ETL disponibile a richiesta.
 ETL version available upon request.

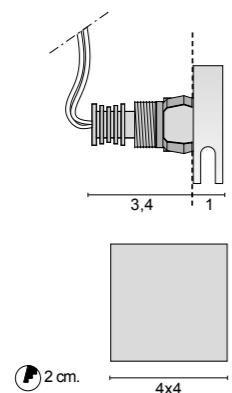

6339 Trim Quadro monoemissione
 .01 Bianco - White
 .45 Alluminio anodizzato
 Aluminium anodized

Color temperature Light sources lm
 /W 4000K LED max 2W 500mA 209lm
 /MW 3000K LED max2W 500mA 199lm

IP 40 0,03 Kg

Versione ETL disponibile a richiesta.
 ETL version available upon request.

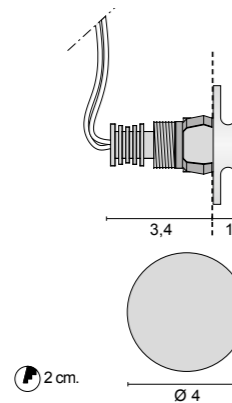

6336 Trim Tondo biemissione
 .01 Bianco - White
 .45 Alluminio anodizzato
 Aluminium anodized

Color temperature Light sources lm
 /W 4000K LED max 2W 500mA 209lm
 /MW 3000K LED max2W 500mA 199lm

IP 40 0,03 Kg

Versione ETL disponibile a richiesta.
 ETL version available upon request.

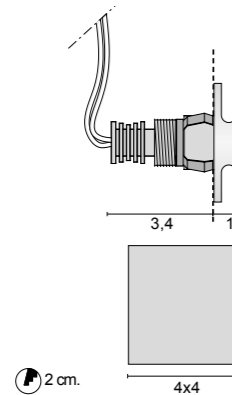

6337 Trim Quadro biemissione
 .01 Bianco - White
 .45 Alluminio anodizzato
 Aluminium anodized

Color temperature Light sources lm
 /W 4000K LED max 2W 500mA 209lm
 /MW 3000K LED max2W 500mA 199lm

IP 40 0,03 Kg

Versione ETL disponibile a richiesta.
 ETL version available upon request.



Accessori - Accessories



0212
 KIT: box + Plaster



0215
 Controcassa in materiale plastico
 Plastic box

Cod.	Drivers ON/OFF		
	0125 350mA	0128 350mA	0127 500mA
6336	1-6	1-10	1-6
6337	1-6	1-10	1-6
6338	1-6	1-10	1-6
6339	1-6	1-10	1-6

Cod.	DIMMABLE drivers			
	0141/DIM PUSH - 1...10V	0141/DALI DIM DALI	0145/DALI DIM DALI	0145 DIM
6336	1-12	1-12	1-21	1-21
6337	1-12	1-12	1-21	1-21
6338	1-12	1-12	1-21	1-21
6339	1-12	1-12	1-21	1-21

DIMMABLE drivers
 Casambi
 0145/CASA

1-21
1-21
1-21
1-21

Solo collegamento in serie - Only serial connection

Decorative lights

Decorative lights

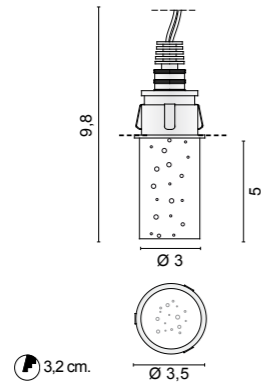

6340 Fire
.00 Trasparente - Clear

Color temperature	Light sources	lm
/W 4000K	LED 1W 350mA	151lm
/WW 3000K	LED 1W 350mA	143lm
/XW 2700K	LED 1W 350mA	138lm

IP 44 0,08 Kg

Versione ETL disponibile a richiesta.
 ETL version available upon request.

Diffusore in metacrilato trasparente con inclusione di bolle.
 Transparent methacrylate diffuser with bubbles enclosure.

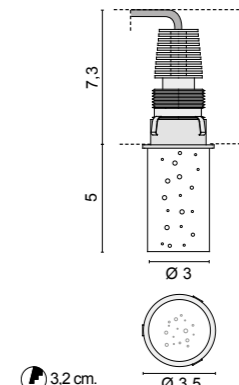

6341 Fire RGB
.00 Trasparente - Clear

Light sources
 LED 3x250mA

IP 40 0,12 Kg

Versione ETL disponibile a richiesta.
 ETL version available upon request.

Diffusore in metacrilato trasparente con inclusione di bolle.
 Transparent methacrylate diffuser with bubbles enclosure.



Decorative lights

Decorative lights

Accessori - Accessories



0213
 KIT: box + Plaster



0216
 Controcassa in materiale plastico
 Plastic box

Accessori - Accessories



0234
 Controcassa in materiale plastico
 Plastic box

Cod.	Drivers ON/OFF		DIMMABLE drivers			
	0125 350mA	0128 350mA	0141/DIM PUSH - 1...10V	0141/DALI DIM DALI	0145/DALI DIM DALI	0145 DIM
6313	1-6	1-10	1-12	1-12	1-21	1-21

DIMMABLE drivers Casambi

0145/CASA	1-21
-----------	------

Drivers RGB	Driver RGB Casambi	Converter RGB	0163	0165	0166
0164 120W IN:230V - OUT: 3x24V	0167 22W 0164/CASA 120W IN:230V - OUT: 3x24V	0168 IN:24V - OUT: 3x250 mA 1-5 Fire RGB	0163 IR Sensor	0165 IR Remote controller	0166 Sinc Cable

Solo collegamento in serie - Only serial connection

Solo collegamento in serie - Only serial connection

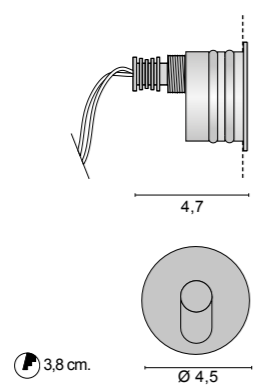

6350 Spoon Tondo

.01 Bianco - White
.45 Alluminio anodizzato - Aluminium anodized

Color temperature	Light sources	lm
/W 4000K	LED max 2W 500mA	209lm
/WW 3000K	LED max 2W 500mA	199lm
/XW 2700K	LED max 2W 500mA	189lm

IP 40 0,07 Kg

Versione ETL disponibile a richiesta. - ETL version available upon request.

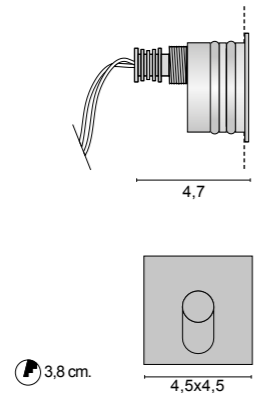

6351 Spoon Quadro

.01 Bianco - White
.45 Alluminio anodizzato - Aluminium anodized

Color temperature	Light sources	lm
/W 4000K	LED max 2W 500mA	209lm
/WW 3000K	LED max 2W 500mA	199lm
/XW 2700K	LED max 2W 500mA	189lm

IP 40 0,07 Kg

Versione ETL disponibile a richiesta. - ETL version available upon request.



Decorative lights

Accessori - Accessories



0214
KIT: box + Plaster



0217
Controcassa in materiale plastico
Plastic box



Cod.	Drivers ON/OFF		
	0125	0128	0127
6350	350mA	350mA	500mA
6351	1-6	1-10	1-6

DIMMABLE drivers			
0141/DIM	0141/DALI	0145/DALI	0145
PUSH - 1...10V	DIM DALI	DIM DALI	DIM
1-12	1-12	1-21	1-21
1-12	1-12	1-21	1-21

DIMMABLE drivers	
Casambi	0145/CASA
1-21	1-21
1-21	1-21

Solo collegamento in serie - Only serial connection

Decorative lights



LUCCIOLA

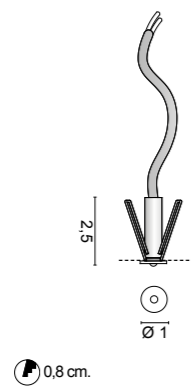

6372 Lucciola
.01 Bianco - White

Color temperature Light sources
/B LED BLU LED 8V DC 0,16W 20mA
/CW 5000K LED 8V DC 0,16W 20mA
/WW 3000K LED 8V DC 0,16W 20mA
/XW 2700K LED 8V DC 0,16W 20mA

IP 40 0,01 Kg

Versione ETL disponibile a richiesta.
 ETL version available upon request.

0.8 cm.

LUCCIOLA RGB

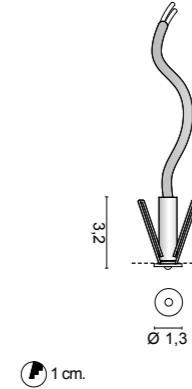

6353 Lucciola RGB
.01 Bianco - White

Light sources
 LED 0,7 12V DC

IP 40 0,01 Kg

Versione ETL disponibile a richiesta.
 ETL version available upon request.

1 cm.

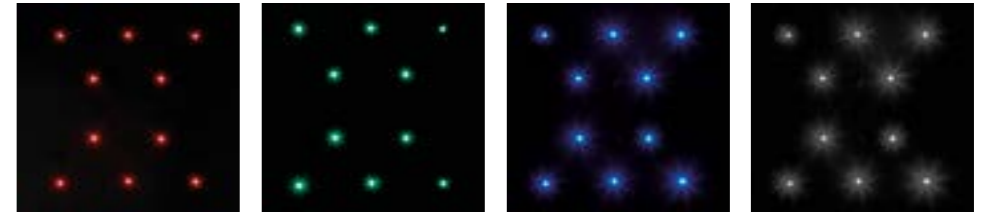

.01/B

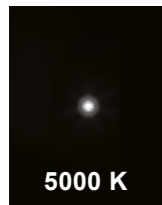

5000 K

.01/CW



3000 K

.01/WW

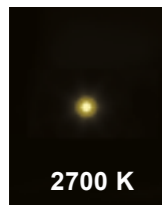

2700 K

.01/XW

Drivers ON/OFF	
Cod.	0130
	8V DC
6372	1-40

Solo collegamento in parallelo, NON dimmerabile - Only parallel connection, NON dimmable.



RGB CONTROLLER		DRIVERS RGB	
Cod.	0152	0159	0173
	Kit centralina RGB + Telecomando	12V	12V
	Kit RGB controller + Remote control	25W	50W
6350		1-26	1-50

Centraline RGB non sincronizzabili tra loro - Solo collegamento in parallelo
 RGB controller cannot be synchronized with each other - Only parallel connection.

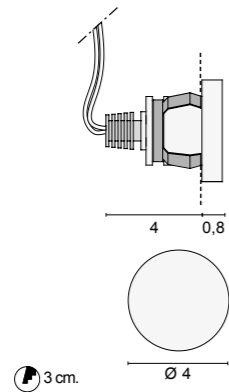

6354 Ice Tondo

.01 Bianco - White

Color temperature	Light sources	lm
/B LED BLU	LED 1W 350mA	
/W 4000K	LED 1W 350mA	151
/WW 3000K	LED 1W 350mA	143
/XW 2700K	LED 1W 350mA	132

IP 44 0,05 Kg

Versione ETL disponibile a richiesta.
ETL version available upon request.

Diffusore in metacrilato satinato.
Frosted methacrylate diffuser.

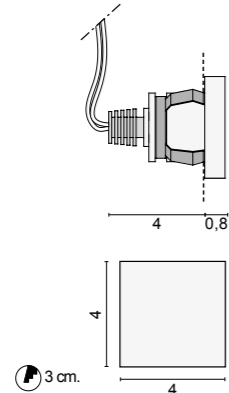

6355 Ice Quadro

.01 Bianco - White

Color temperature	Light sources	lm
/B LED BLU	LED 1W 350mA	
/W 4000K	LED 1W 350mA	151
/WW 3000K	LED 1W 350mA	143
/XW 2700K	LED 1W 350mA	132

IP 44 0,04 Kg

Versione ETL disponibile a richiesta.
ETL version available upon request.

Diffusore in metacrilato satinato.
Frosted methacrylate diffuser.



.01/B .01/W 4000 K .01/WW 3000 K .01/XW 2700 K



Accessori - Accessories



0213
KIT: box + Plaster



0216
Controcassa in materiale plastico
Plastic box

Cod.	Drivers ON/OFF		DIMMABLE drivers			
	0125 350mA	0128 350mA	0141/DIM PUSH - 1...10V	0141/DALI DIM DALI	0145/DALI DIM DALI	0145 DIM
6354	1-6	1-10	1-12	1-12	1-21	1-21
6355	1-6	1-10	1-12	1-12	1-21	1-21

Solo collegamento in serie - Only serial connection

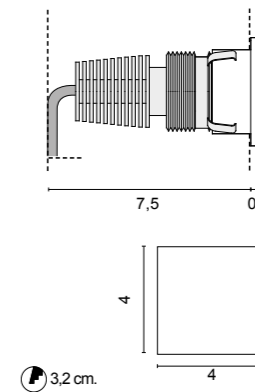

6377 Ice quadro RGB

.01 Bianco - White

Light sources
LED 3x250mA

IP 44 0,08 Kg

Versione ETL disponibile a richiesta.
ETL version available upon request.

Diffusore in metacrilato satinato.
Frosted methacrylate diffuser.

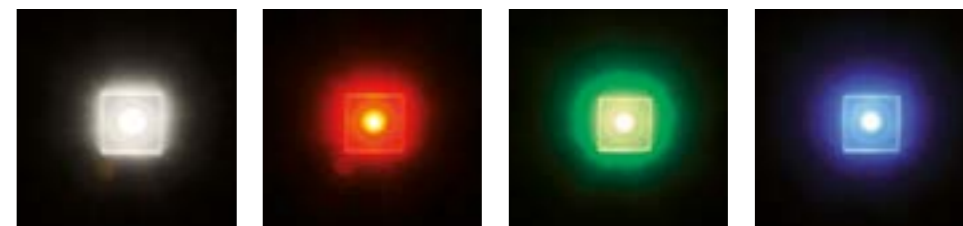

Accessori - Accessories



0234
Controcassa in materiale plastico
Plastic box

Drivers RGB		Driver RGB Casambi	Converter RGB	0163	0165	0166
0164 120W	0167 22W	0164/CASA 120W	0168 IN:24V - OUT: 3x250 mA 1-5 Ice RGB	IR Sensor	IR Remote controller	Sinc Cable
IN:230V - OUT: 3x24V		IN:230V - OUT: 3x24V				

Solo collegamento in serie - Only serial connection

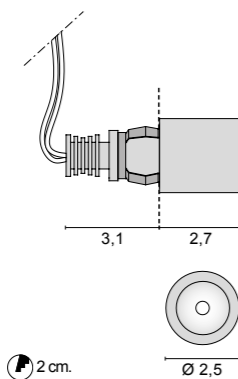

6356 Byte Tondo

.01 Bianco - White

Color temperature	Light sources	lm
W 4000K	LED max 2W 500mA	209lm
MW 3000K	LED max 2W 500mA	199lm
XW 2700K	LED max 2W 500mA	189lm

F II IP 40 25° R 0,03 Kg

Versione ETL disponibile a richiesta.
ETL version available upon request.

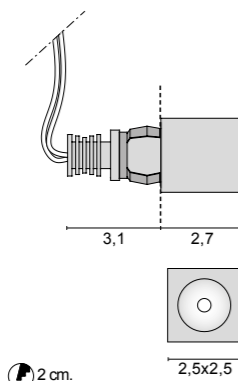

6357 Byte Quadro

.01 Bianco - White

Color temperature	Light sources	lm
W 4000K	LED max 2W 500mA	209lm
MW 3000K	LED max 2W 500mA	199lm
XW 2700K	LED max 2W 500mA	189lm

F II IP 40 25° R 0,03 Kg

Versione ETL disponibile a richiesta.
ETL version available upon request.



Decorative lights

Decorative lights

Accessori - Accessories



0212
KIT: box + Plaster



0215
Controcassa in materiale plastico
Plastic box

Cod.	Drivers ON/OFF		
	0125 350mA	0128 350mA	0127 500mA
6356	1-6	1-10	1-6
6357	1-6	1-10	1-6

DIMMABLE drivers			
0141/DIM PUSH - 1...10V	0141/DALI DIM DALI	0145/DALI DIM DALI	0145 DIM
1-12	1-12	1-21	1-21
1-12	1-12	1-21	1-21

DIMMABLE drivers Casambi	
0145/CASA	
1-21	
1-21	

Solo collegamento in serie - Only serial connection



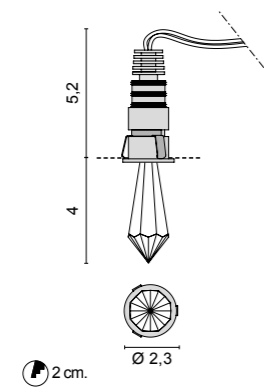

6359 Sirio
 .50 Cristallo - Crystal

Color temperature	Light sources	lm
/W 4000K	LED 1W 350mA	151lm
/WW 3000K	LED 1W 350mA	143lm
/XW 2700K	LED 1W 350mA	138lm

F III IP 44 R 0,03 Kg

Versione ETL disponibile a richiesta.
 ETL version available upon request.



Decorative lights

Decorative lights

Accessori - Accessories



0212
 KIT: box + Plaster



0215
 Controcassa in materiale plastico
 Plastic box

Cod.	Drivers ON/OFF		
	0125	0128	0127
	350mA	350mA	500mA
6359	1-6	1-10	1-6

DIMMABLE drivers			
0141/DIM	0141/DALI	0145/DALI	0145
PUSH - 1...10V	DIM DALI	DIM DALI	DIM
1-12	1-12	1-21	1-21

DIMMABLE drivers	
Casambi	0145/CASA
1-21	

Solo collegamento in serie - Only serial connection

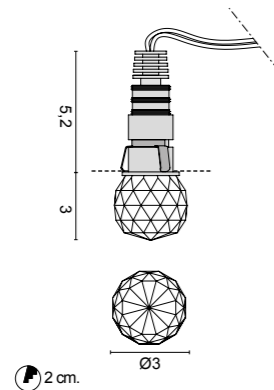

6358 Vega
.50 Cristallo - Crystal

Color temperature	Light sources	lm
/W 4000K	LED 1W 350mA	151lm
/WW 3000K	LED 1W 350mA	143lm
/XW 2700K	LED 1W 350mA	138lm

IP 44 R 0,06 Kg
 Versione ETL disponibile a richiesta.
 ETL version available upon request.



Decorative lights

Accessori - Accessories



0212
KIT: box + Plaster



0215
Controcassa in materiale plastico
Plastic box

Cod.	Drivers ON/OFF		
	0125	0128	0127
	350mA	350mA	500mA
6358	1-6	1-10	1-6

DIMMABLE drivers			
0141/DIM	0141/DALI	0145/DALI	0145
PUSH - 1...10V	DIM DALI	DIM DALI	DIM
1-12	1-12	1-21	1-21

DIMMABLE drivers Casambi
0145/CASA
1-21

Solo collegamento in serie - Only serial connection

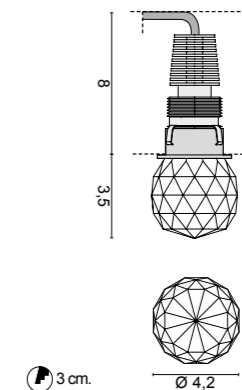

6378 Vega Maxi RGB
.50 Cristallo - Crystal

Light sources
 LED 3x250mA

IP 44 R 0,16 Kg
 Versione ETL disponibile a richiesta.
 ETL version available upon request.

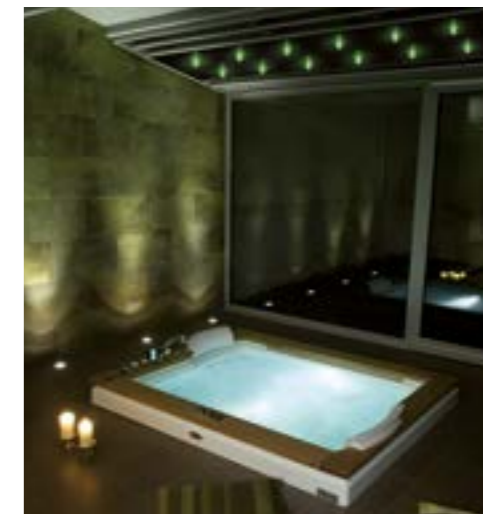
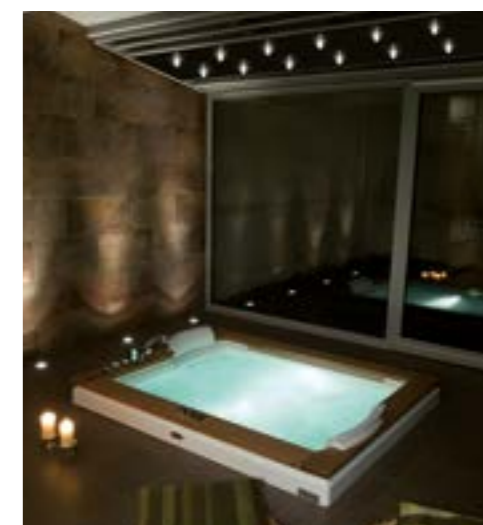
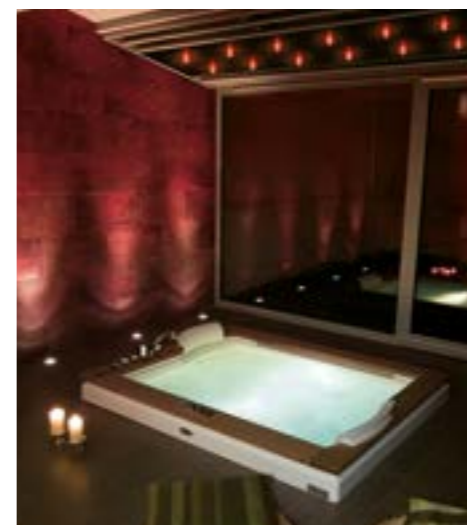

Decorative lights

Accessori - Accessories



0234
Controcassa in materiale plastico
Plastic box

Drivers RGB	
0164	0167
120W	22W
IN:230V - OUT: 3x24V	

Driver RGB Casambi
0164/CASA
120W
IN:230V - OUT: 3x24V

Converter RGB
0168
IN:24V - OUT: 3x250 mA 1-5 Vega RGB

0163	0165	0166
IR Sensor	IR Remote controller	Sinc Cable

Solo collegamento in serie - Only serial connection

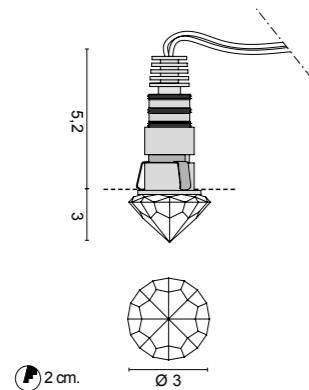

6360 Alcor
.50 Cristallo - Crystal

Color temperature	Light sources	lm
W 4000K	LED 1W 350mA	151lm
MW 3000K	LED 1W 350mA	143lm
XW 2700K	LED 1W 350mA	138lm

0,03 Kg
 Versione ETL disponibile a richiesta.
 ETL version available upon request.



Decorative lights

Accessori - Accessories



0212
KIT: box + Plaster



0215
Controcassa in materiale plastico
Plastic box

Cod.	Drivers ON/OFF		
	0125	0128	0127
	350mA	350mA	500mA
6360	1-6	1-10	1-6

DIMMABLE drivers			
0141/DIM	0141/DALI	0145/DALI	0145
PUSH - 1...10V	DIM DALI	DIM DALI	DIM
1-12	1-12	1-21	1-21

DIMMABLE drivers Casambi
0145/CASA
1-21

Solo collegamento in serie - Only serial connection

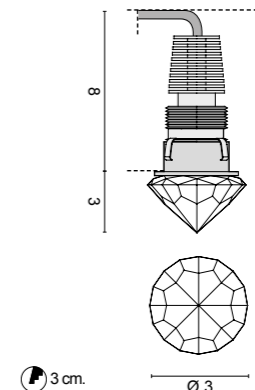

6379 Alcor Maxi RGB
.50 Cristallo - Crystal

Light sources
 LED 3x250mA

0,12 Kg
 Versione ETL disponibile a richiesta.
 ETL version available upon request.

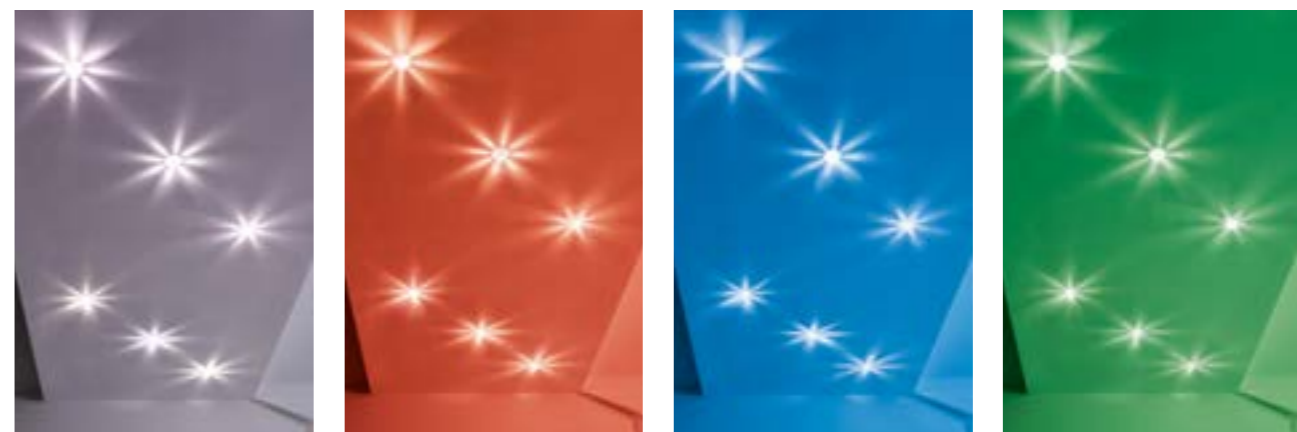

Decorative lights

Accessori - Accessories



0234
Controcassa in materiale plastico
Plastic box

Drivers RGB
0164
120W
IN:230V - OUT: 3x24V

Driver RGB Casambi
0164/CASA
120W
IN:230V - OUT: 3x24V

Converter RGB
0168
IN:24V - OUT: 3x250 mA 1-5 Alcor RGB

0163	0165	0166
IR Sensor	IR Remote controller	Sinc Cable

Solo collegamento in serie - Only serial connection

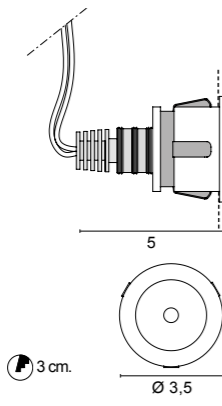

6363 Top
.01 Bianco - White

Color temperature	Light sources	lm
/W 4000K	LED max 2W 500mA	209lm
/WW 3000K	LED max 2W 500mA	199lm
/XW 2700K	LED max 2W 500mA	189lm

0,03 Kg

Versione ETL disponibile a richiesta.
 ETL version available upon request.

Accessori - Accessories



0213
 KIT: box + Plaster



0216
 Controcassa in materiale plastico
 Plastic box

Cod.	Drivers ON/OFF		
	0125	0128	0127
6356	350mA 1-6	350mA 1-10	500mA 1-6

DIMMABLE drivers			
0141/DIM	0141/DALI	0145/DALI	0145
PUSH - 1...10V	DIM DALI	DIM DALI	DIM
1-11	1-12	1-21	1-21

DIMMABLE drivers
Casambi
0145/CASA
1-21

Solo collegamento in serie - Only serial connection

TOP mini

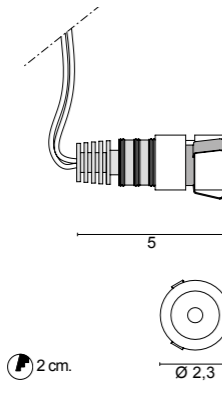

6364 Top Mini
.01 Bianco - White

Color temperature	Light sources	lm
/W 4000K	LED max 1W 350mA	151lm
/WW 3000K	LED max 1W 350mA	143lm
/XW 2700K	LED max 1W 350mA	135lm

0,02 Kg

Versione ETL disponibile a richiesta.
 ETL version available upon request.

Accessori - Accessories



0212
 KIT: box + Plaster



0215
 Controcassa in materiale plastico
 Plastic box

Cod.	Drivers ON/OFF	
	0125	0128
6364	350mA 1-6	350mA 1-10

DIMMABLE drivers			
0141/DIM	0141/DALI	0145/DALI	0145
PUSH - 1...10V	DIM DALI	DIM DALI	DIM
1-12	1-12	1-21	1-21

DIMMABLE drivers
Casambi
0145/CASA
1-21

Solo collegamento in serie - Only serial connection



Art. 6364 Top Mini

Art. 6363 Top

Decorative lights



Decorative lights

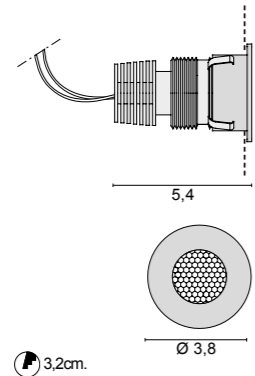

6322 Pix Tondo

- .01 Bianco - White
- .32 Nickel satinato - Nickel mat

Color temperature	Optics	Light sources	lm
0107/W	4000K /11 /25 /45	LED max 2W 500mA	209lm
0107/WW	3000K /11 /25 /45	LED max 2W 500mA	199lm
0107/XW	2700K /11 /25 /45	LED max 2W 500mA	189lm

IP 40 0,06 Kg

Versione ETL disponibile a richiesta.
ETL version available upon request.

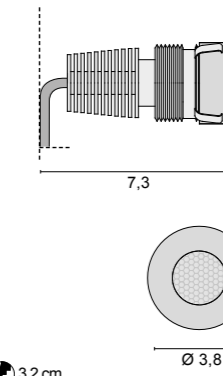

6375 Pix Tondo RGB

- .01 Bianco - White
- .32 Nickel satinato - Nickel mat

Light sources
LED 3x250mA

IP 40 0,1 Kg

Versione ETL disponibile a richiesta.
ETL version available upon request.

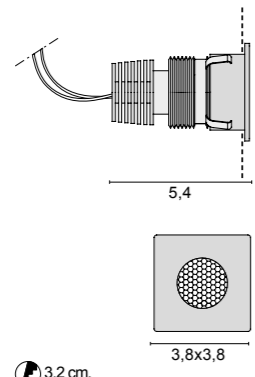

6323 Pix Quadro

- .01 Bianco - White
- .32 Nickel satinato - Nickel mat

Color temperature	Optics	Light sources	lm
0107/W	4000K /11 /25 /45	LED max 2W 500mA	209lm
0107/WW	3000K /11 /25 /45	LED max 2W 500mA	199lm
0107/XW	2700K /11 /25 /45	LED max 2W 500mA	189lm

IP 40 0,06 Kg

Versione ETL disponibile a richiesta.
ETL version available upon request.



Decorative lights



Decorative lights

Accessori - Accessories



0209
Adattatore per doghe



0213
KIT: box + Plaster



0234
Controcassa in materiale plastico
Plastic box

Accessori - Accessories



0209
Adattatore per doghe



0234
Controcassa in materiale plastico
Plastic box

Cod.	Drivers ON/OFF		
	0125	0128	0127
	350mA	350mA	500mA
6322	1-6	1-10	1-6
6323	1-6	1-10	1-6

DIMMABLE drivers			
0141/DIM	0141/DALI	0145/DALI	0145
PUSH - 1...10V	DIM DALI	DIM DALI	DIM
1-12	1-12	1-21	1-21
1-12	1-12	1-21	1-21

DIMMABLE drivers Casambi	
0145/CASA	
1-21	
1-21	

Solo collegamento in serie - Only serial connection

Drivers RGB		Driver RGB Casambi	Converter RGB
0164	0167	0164/CASA	0168
120W	22W	120W	
IN:230V - OUT: 3x24V		IN:230V - OUT: 3x24V	IN:24V - OUT: 3x250 mA 1-5 Pix RGB

0163	0165	0166
IR Sensor	IR Remote controller	Sinc Cable

Solo collegamento in serie - Only serial connection

CERCHIETTO

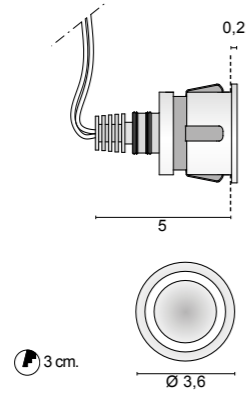

6391 Cerchietto

.01 Bianco - White

Color temperature	Light sources	lm
/B LED BLU	LED 1W 350mA	
/W 4000K	LED max 2W 500mA	209lm
/WW 3000K	LED max 2W 500mA	199lm
/XW 2700K	LED max 2W 500mA	189lm

IP 44 0,04 Kg

Versione ETL disponibile a richiesta.
ETL version available upon request.



.01/B



.01/W



.01/WW



.01/XW

Accessori - Accessories



0213

KIT: box + Plaster



0216

Controcassa in materiale plastico
Plastic box

Cod.	Drivers ON/OFF			DIMMABLE drivers				DIMMABLE drivers Casambi
	0125	0128	0127	0141/DIM	0141/DALI	0145/DALI	0145	
6391	350mA	350mA	500mA	PUSH - 1...10V	DIM DALI	DIM DALI	DIM	0145/CASA
	1-6	1-10	1-6	1-11	1-12	1-21	1-21	1-21

Solo collegamento in serie - Only serial connection

CRUISE

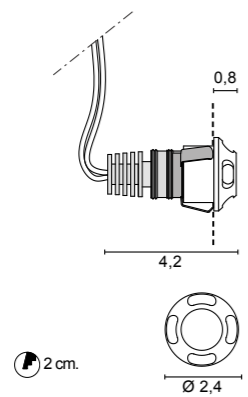

6382 Cruise

.01 Bianco - White

Color temperature	Light sources	lm
/B LED BLU	LED 1W 350mA	
/W 4000K	LED 1W 500mA	151lm
/WW 3000K	LED 1W 500mA	143lm
/XW 2700K	LED 1W 500mA	135lm

IP 44 0,02 Kg

Versione ETL disponibile a richiesta.
ETL version available upon request.

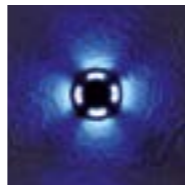

.01/B



.01/W

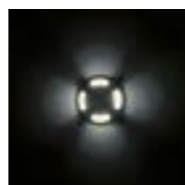

.01/WW

Accessori - Accessories



0212

KIT: box + Plaster



0215

Controcassa in materiale plastico
Plastic box

Cod.	Drivers ON/OFF			DIMMABLE drivers				DIMMABLE drivers Casambi
	0125	0128	0127	0141/DIM	0141/DALI	0145/DALI	0145	
6382	350mA	350mA		PUSH - 1...10V	DIM DALI	DIM DALI	DIM	0145/CASA
	1-6	1-10		1-12	1-12	1-21	1-21	1-21

Solo collegamento in serie - Only serial connection

SLOT

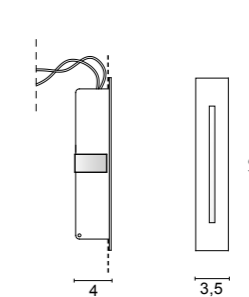

6381 Slot

.01 Bianco - White

Color temperature	Light sources	lm
/W 4000K	LED 1W 350mA	151lm
/WW 3000K	LED 1W 350mA	143lm
/XW 2700K	LED 1W 350mA	135lm

IP 44 0,02 Kg

Versione ETL disponibile a richiesta.
ETL version available upon request.

2,3x17 cm.

Accessori - Accessories



0249

KIT: box + Plaster

Cod.	Drivers ON/OFF			DIMMABLE drivers				DIMMABLE drivers Casambi
	0125	0128	0127	0141/DIM	0141/DALI	0145/DALI	0145	
6381	350mA	350mA		PUSH - 1...10V	DIM DALI	DIM DALI	DIM	0145/CASA
	1-6	1-10		1-12	1-12	1-21	1-21	1-21

Solo collegamento in serie - Only serial connection

Decorative lights

Decorative lights



	pag.
EDISON SYSTEM CEILING	230
EDISON SYSTEM SUSPENSION	230
TAPPO EDISON SPOT E27	234
GEKO EDISON SPOT E27	234

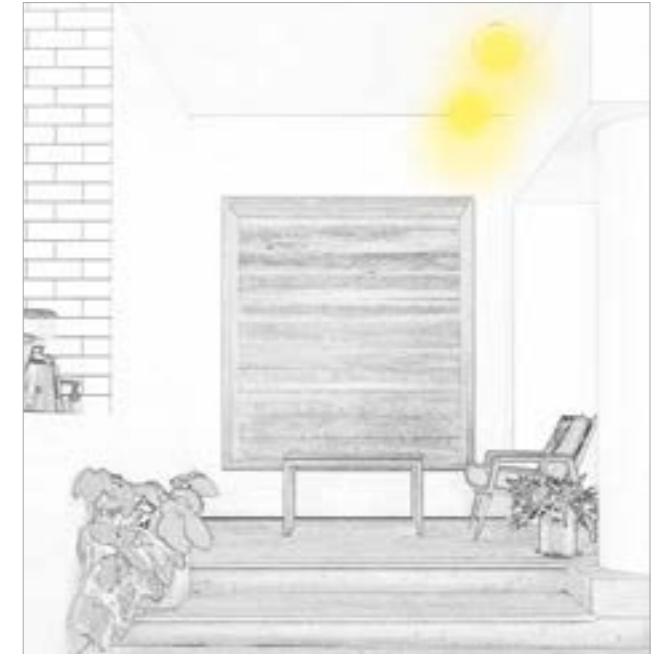



Spots encastrés et système d'éclairage qui utilisent la gamme des toutes nouvelles ampoules LED avec douille E 27. (v. page 236)

Dans les deux collections les socles sont réglables en hauteur pour s'adapter à la forme et la taille de l'ampoule en la valorisant.

Les SPOTS EDISON avec cadre (Geko) ou minitrim (Tappo) sont en alu injecté laqués blancs ou en finition chromée ou cuivrée.

EDISON SISTEMA est un système modulaire et facile à installer et se compose d'un plafonnier et une suspension et vient se composer avec une série d'accessoires qui permettent de multiplier les points d'éclairage à partir d'un seul point d'alimentation électrique.

Focos empotrados y sistema de iluminación que ofrece una amplia selección de las últimas bombillas decorativas con filamento LED con portalámparas E27 (ver página 236)

En ambas colecciones, los portalámparas se pueden ajustar en altura para valorar la forma y la decoración de la fuente.

Los focos empotrados EDISON con marco (Geko) y minitrim (Tappo) son de aluminio fundido y están pintados de blanco y con acabado galvanizado cromado o cobre.

EDISON SISTEMA modulares y fácil de instalar consta de un elemento de techo y un elemento de suspensión. Se completa con una serie de accesorios, para cables, desviadores y flaron que permiten multiplicar los puntos de luz desde una fuente de alimentación inicial de la pared o desde el techo

Einbaustrahler und Beleuchtungssystem mit einer großen Auswahl der neuesten LED-Glühlampen mit E27-Fassung. (siehe Seite 236) In beiden Kollektionen können die Lampenfassungen in der Höhe verstellt werden, um die Form und Dekoration der Quelle voll zu betonen.

EDISON SISTEMA, modular und einfach zu installieren, besteht aus einem Deckenelement und einem Aufhängeelement. Mit Zubehör, Kabeln, Umlenkern und Rosetten können die Lichtpunkte von der ersten Stromversorgung bis zur Wand oder Decke vervielfacht werden.

Die EDISON Einbaustrahler mit Rahmen (GEKO) und Minitrim (TAPPO) bestehen aus Aluminiumdruckguss und sind weiß lackiert oder verchromt oder kupfergalvanisiert.

Встраиваемые прожекторы и система освещения предлагают широкий выбор новейших светодиодных декоративных лампочек накаливания с цоколем E27. (см. стр. 236) В обеих коллекциях патроны могут быть отрегулированы по высоте, чтобы полностью улучшить форму и оформление источника.

EDISON SISTEMA, модульная и простая в установке, состоит из потолочного элемента и элемента подвески. Аксессуары, кабели, отклонители и розетки позволяют увеличить количество точек освещения, начиная с первоначального источника питания на стене или потолке.

Встраиваемые прожекторы EDISON с рамой (GEKO) и минитримом (TAPPO) выполнены из литого алюминия и окрашены в белый цвет или имеют хромированную или медную гальваническую отделку.

EDISON *design: U.T. EGOLUCE*

Faretti da incasso e sistema d'illuminazione che propongono una vasta scelta delle nuovissime lampadine decorative a filamento LED con attacco E27. (vedi pag 236)

In entrambe le collezioni i portalampada sono regolabili in altezza consentendo di valorizzare a pieno la forma e la decorazione della sorgente.

I faretti EDISON incasso con cornice (GEKO) e minitrim (TAPPO) sono in alluminio pressofuso e sono verniciati bianchi o con finitura galvanica cromo o rame.

EDISON SISTEMA, componibile e di facile installazione, è costituito da un elemento a plafone e uno a sospensione. Si completa con una serie di accessori, cavi, deviatori e rosoni che permettono di moltiplicare i punti luce partendo da un'alimentazione iniziale a parete o soffitto.

Recessed spotlights and lighting system offering a vast selection of the latest LED filament decorative bulbs with E27 socket. (see page 236)

In both collections, the lamp holders can be adjusted in height to fully enhance the shape and decoration of the source.

EDISON SISTEMA, modular and easy to install, consists of a ceiling element and a suspension element. The accessories, cables, diverters and rosettes allow to multiply the light points starting from an initial power supply to the wall or ceiling.

The EDISON recessed spotlights with frame (GEKO) and minitrim (TAPPO) are in die-cast aluminum and are painted white or with a chrome or copper galvanic finish.



5612 Edison PLAFONE - CEILING

- .01 Bianco - White
- .02 Nero - Black
- .25 Dorato satinato - Golded satin
- .32 Nickel satinato - Nickel mat

Light sources

E27 LED max 7W

Lampadine decorative a ilamento LED con attacco E27 pag. 236
LED ilament decorative bulbs with E27 socket pag. 236

0,60 Kg

- Predisposto per 4 collegamenti.
Prepared for 4 connections.

5612.01 Bianco - White + 01LP6

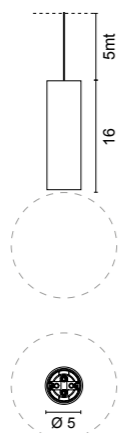

1598 Edison SUSPENSION

- .01 Bianco - White
- .02 Nero - Black
- .25 Dorato satinato - Golded satin
- .32 Nickel satinato - Nickel mat

Light sources

E27 LED max 7W

Lampadine decorative a ilamento LED con attacco E27 pag. 236
LED ilament decorative bulbs with E27 socket pag. 236

0,40 Kg

- Lunghezza cavo 5mt.
Cable length 5mt.

6560.31 Cromato - Chromed + 01LCR3

Accessori - Accessories



0603
Rosone da 1 a 4 uscite
50/60Hz 220-240V
Ceiling rose with 1 - 4 holes
50/60Hz 220-240V

- .01 Bianco - White
- .02 Nero - Black



0604
Rosone - 1 uscita
50/60Hz 220-240V
Ceiling rose with 1 hole
50/60Hz 220-240V

- .01 Bianco - White
- .02 Nero - Black



0946
Rosone per sospensione - 1 uscita
50/60Hz 220-240V
Ceiling rose for suspension - 1 hole
50/60Hz 220-240V

- .01 Bianco - White
- .02 Nero - Black



0605
Deviatore e decentratore - Ø 1,7 H 2,2
Displacement element - Ø 1,7 H 2,2

- .01 Bianco - White
- .02 Nero - Black

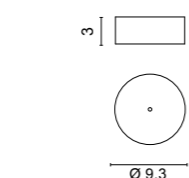
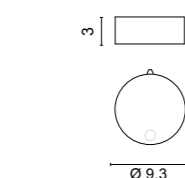
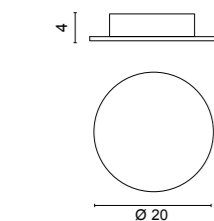

0606
Cavo con rivestimento in tessuto 5mt.
Textile covered cable 5mt.

- .01 Bianco - White
- .02 Nero - Black

0,40 Kg

0,15 Kg

0,20 Kg

Esempi di configurazioni - Configuration example

0605
Deviatore e decentratore
Displacement element

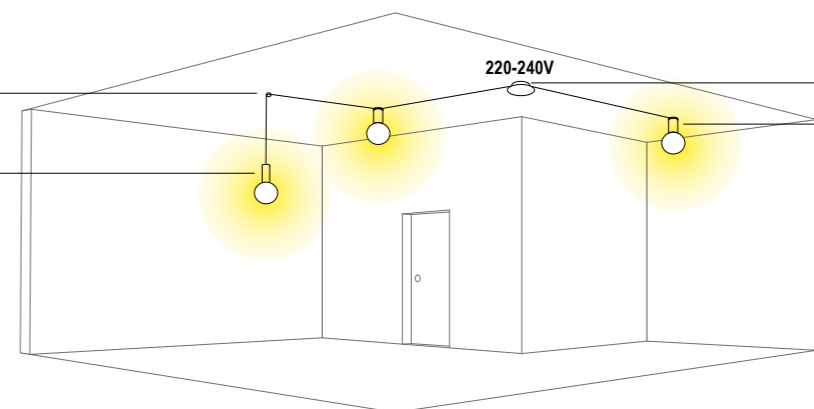

0603
Rosone da 1 a 4 uscite
50/60Hz 220-240V
Ceiling rose with 1 - 4 holes
50/60Hz 220-240V

5612
Edison Plafone
Predisposto per 4 collegamenti.
Prepared for 4 connections.

1598
Edison Suspension
Lunghezza cavo 5mt.
Cable length 5mt.

0603
Rosone da 1 a 4 uscite
50/60Hz 220-240V
Ceiling rose with 1 - 4 holes
50/60Hz 220-240V

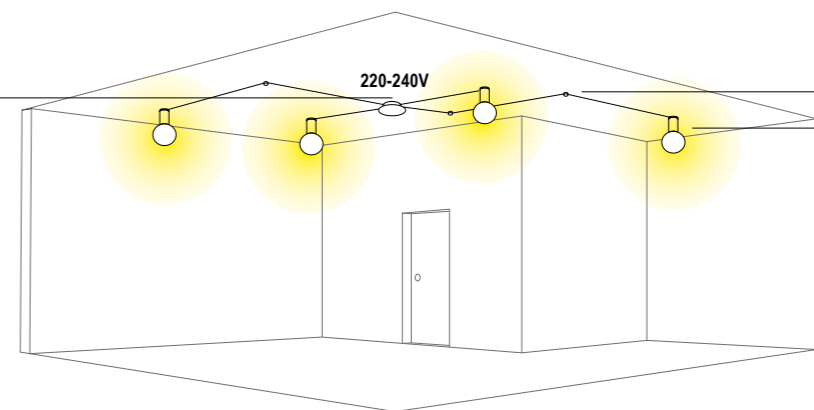

0605
Deviatore e decentratore
Displacement element

5612
Edison Plafone
Predisposto per 4 collegamenti.
Prepared for 4 connections.

5612
Edison Plafone
Predisposto per 4 collegamenti.
Prepared for 4 connections.

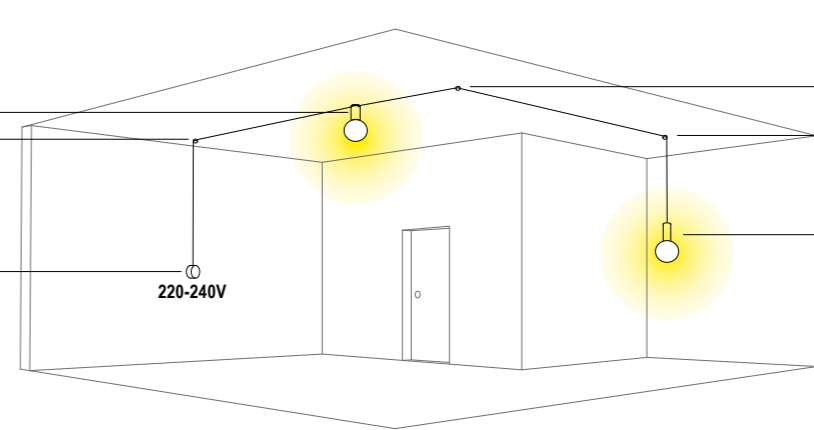

0605
Deviatore e decentratore
Displacement element

0605
Deviatore e decentratore
Displacement element

1598
Edison Suspension
Lunghezza cavo 5mt.
Cable length 5mt.

5612
Edison Plafone
Predisposto per 4 collegamenti.
Prepared for 4 connections.

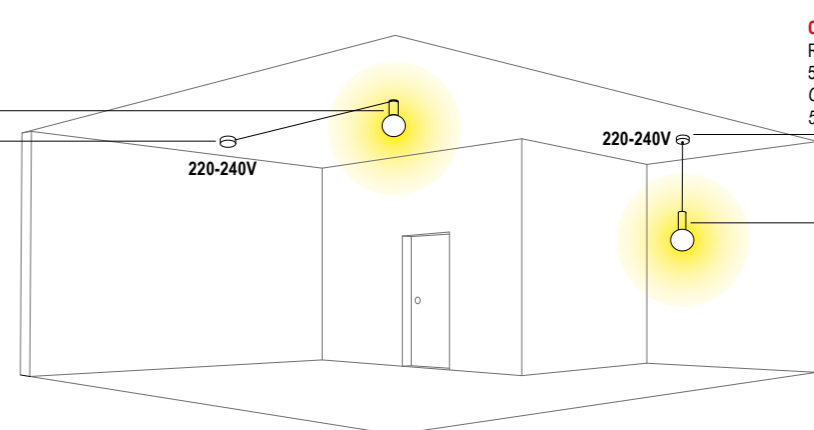

0946
Rosone per sospensione - 1 uscita
50/60Hz 220-240V
Ceiling rose for suspension - 1 hole
50/60Hz 220-240V

1598
Edison Suspension
Lunghezza cavo 5mt.
Cable length 5mt.



EDISON System con lampadina **01LP8** . - EDISON System with bulb **01LP8**



EDISON System con lampadina **01LCR1** . - EDISON System with bulb **01LCR1**.



5612.25
Dorato satinato - *Golded satin* + **01LS1**



5612.01
Bianco - *White* + **01LP7**



5612.32
Nickel satinato - *Nickel mat* + **01LCR1**



5612.02
Nero - *Black* + **01LC03**

TAPPO EDISON SPOT

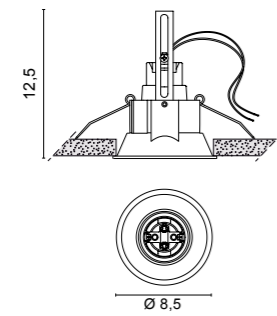

7.9 cm.

6561 Tappe E27

- .01 Bianco - White
- .31 Cromato - Chromed
- .38 Ramato lucido - Shiny copper

Light sources

E27 LED max 7W

Lampadine decorative a filamento LED con attacco E27 pag. 216
LED filament decorative bulbs with E27 socket pag. 236

0,22 Kg



6561.01 Bianco - White + 01LP6



6561.31 Cromato - Chromed + 01LC1



6561.38 Ram lucido - Shiny copper + 01LC2

GEKO EDISON SPOT

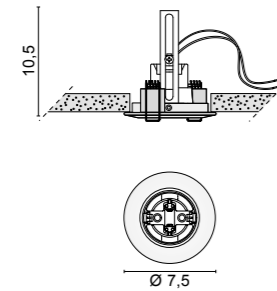

6.6 cm.

6560 Geko E27

- .01 Bianco - White
- .31 Cromato - Chromed

Light sources

E27 LED max 7W

Lampadine decorative a filamento LED con attacco E27 pag. 216
LED filament decorative bulbs with E27 socket pag. 236

0,15 Kg



6560.01 Bianco - White + 01LP2



6560.31 Cromato - Chromed + 01LCR3

EDISON SPOT



TAPPO EDISON con lampadina 01LP6 - TAPPO EDISON with bulb 01LP6



6560.01 Bianco - White + 01LP7



6560.31 Cromato - Chromed + 01LCR1



6560.31 Cromato - Chromed + 01LCO1



6560.01 Bianco - White + 01LCO4

CUPOLA

Lampade Led con innovativi cob a spirale in grado di creare ambientazioni particolarmente gradevoli e rilassanti

Led lamps with innovative spiral coils able to create particularly pleasant and relaxing settings

Ø 12,5



17,5

01LC1

Argento - Silver

Color temperature	Light sources	lm
2700K	E27 LED 7W	806lm

Dimmerabile - Dimmable

Ø 12,5



17,5

01LC2

Rame - Copper

Color temperature	Light sources	0,00 Kg	lm
2700K	E27 LED 7W		806lm

Dimmerabile - Dimmable

CORIANDOLI

Gamma di lampadine LED con vetri colorati in diverse varianti: uniformi, sfumati, bicolori. Le particolari forme dei bulbi di vetro e il filamento LED curvo esaltano i colori e creano scenari e giochi di colori unici. Le lampade sono un'esplosione di colori, una festa allegra ed estrosa oppure una elegante manifestazione di stili che si abbina a qualunque arredo. I filamenti Led curvi sono un'arte, non sono solo sorgenti luminose. Dimmerabile con LED dimmer IGBT.

LED bulbs with colored glass in different variants: uniform, shaded, two-colored. The particular shapes of the glass bulbs and the curved LED filament enhance the colors and create scenarios and unique play of colors. The lamps are an explosion of colors, a cheerful and whimsical party or an elegant manifestation of styles that goes well with any decor. Curved LED filaments are an art, they are not just light sources. Dimmable with IGBT dimmer LED.

Ø 12,5



17,2

01LCO1

Nero trasparente - Black transparent

Color temperature	Light sources	lm
2700K	E27 LED 4W	150lm

Dimmerabile - Dimmable

Ø 14



20

01LCO2

Nero trasparente - Black transparent

Color temperature	Light sources	lm
2700K	E27 LED 4W	150lm

Dimmerabile - Dimmable

Ø 14



20

01LCO3

Nero trasparente - Black transparent

Color temperature	Light sources	lm
2700K	E27 LED 4W	150lm

Dimmerabile - Dimmable

Ø 12,5



17,2

01LCO4

Blu rosa - Blue pink

Color temperature	Light sources	lm
2700K	E27 LED 4W	150lm

Dimmerabile - Dimmable

Ø 18



27

01LCO5

Blu rosa - Blue pink

Color temperature	Light sources	lm
2700K	E27 LED 4W	150lm

Dimmerabile - Dimmable



TAPPO EDISON con lampadina **01LCO3**
TAPPO EDISON with bulb **01LCO3**



GEKO EDISON con lampadina **01LCR3** - GEKO EDISON with bulb **01LCR3**

PORCELLANA

Lampadine LED con un particolare effetto simil porcellana realizzato con una speciale satinatura del vetro sia interna che esterna.

LED bulbs with a particular porcelain effect made with a special satin finish on the glass both inside and outside.



01LP1
Porcellana - Porcelain

Color temperature	Light sources	lm
2700K	E27 LED 6W	540lm

Dimmerabile - Dimmable

CRI >90



01LP2
Porcellana - Porcelain

Color temperature	Light sources	lm
2700K	E27 LED 6W	540lm

Dimmerabile - Dimmable

CRI >90



01LP3
Porcellana - Porcelain

Color temperature	Light sources	lm
2700K	E27 LED 6W	540lm

Dimmerabile - Dimmable

CRI >90



01LP4
Porcellana - Porcelain

Color temperature	Light sources	lm
2700K	E27 LED 6W	540lm

Dimmerabile - Dimmable

CRI >90



01LP5
Porcellana - Porcelain

Color temperature	Light sources	lm
2700K	E27 LED 6W	540lm

Dimmerabile - Dimmable

CRI >90



01LP6
Porcellana - Porcelain

Color temperature	Light sources	lm
2700K	E27 LED 6W	540lm

Dimmerabile - Dimmable

CRI >90



01LP7
Porcellana - Porcelain

Color temperature	Light sources	lm
2700K	E27 LED 6W	540lm

Dimmerabile - Dimmable

CRI >90



01LP8
Porcellana - Porcelain

Color temperature	Light sources	lm
2700K	E27 LED 6W	540lm

Dimmerabile - Dimmable

CRI >90

CRISTALLO

Lampadina LED di grande effetto visivo. Grazie alle particolari sfaccettature del vetro e la sorgente luminosa porta in una precisa posizione è in grado di generare incredibili giochi di luce ricreando l'effetto dei calici di cristallo o di antiche bottiglie. L'alto flusso e la possibilità di dimmerazione rendono la lampadina adatta sia per uso domestico che per attività.

LED bulbs with great visual effect. Thanks to the particular facets of the glass and the light source leads to a precise position, it is able to generate incredible plays of light recreating the effect of crystal glasses or antique bottles. The high flow and the possibility of dimming make the bulb suitable for both domestic and business use.



01LCR1
Vetro trasparente - Clear glass

Color temperature	Light sources	lm
2700K	E27 LED 6W	600lm

Dimmerabile - Dimmable

CRI >90



01LCR2
Vetro trasparente - Clear glass

Color temperature	Light sources	lm
2700K	E27 LED 6W	600lm

Dimmerabile - Dimmable

CRI >90



01LCR3
Vetro trasparente - Clear glass

Color temperature	Light sources	lm
2700K	E27 LED 6W	600lm

Dimmerabile - Dimmable

CRI >90



01LCR4
Vetro trasparente - Clear glass

Color temperature	Light sources	lm
2700K	E27 LED 6W	600lm

Dimmerabile - Dimmable

CRI >90

SCINTILLA

Innovativa lampadina con LED rigidi a forma di spirale in grado di emettere una luce diffusa con l'incredibile effetto di minimizzare ombre tipiche dei filamenti dritti. La sorgente puntiforme replica nella maniera più fedele la vecchia lampadina incandescente rendendo gradevole e unico l'effetto.

Innovative spiral-shaped LED bulbS capable of emitting diffused light with the incredible effect of minimizing typical shadows of straight filaments. The point source replicates in the most faithful way the old incandescent bulb making the effect pleasant and unique.



01LS1
Vetro trasparente - Clear glass

Color temperature	Light sources	lm
2700K	E27 LED 4,5W	430lm

CRI >90

	pag.
KEPI'	244
VISION 1	246
VISION 3	247
VISION 3 COB	247
GEO MONOEMISSIONE	248
GEO BIEMISSIONE	248
SPOOK	252
WANDA	258
WANDA RGB	258
ZEPPELIN TONDO	262
ZEPPELIN QUADRO	262
ZEPPELIN TONDO RGB	263
ZEPPELIN QUADRO RGB	263
ZEPPELIN TONDO 25 PLUS	264
ZEPPELIN QUADRO 25 PLUS	264
ZEPPELIN MAXI COB	266
ZEPPELIN MAXI TONDO	267
ZEPPELIN MAXI QUADRO	267
ZEPPELIN ORIENTABILE	268
TRIS	270
SOFT	271
CERCHIO	272
CERCHIO RGB	273
STEP TONDO	274
STEP QUADRO	274
KROSS	275
VISTA	276
DRIVE	277

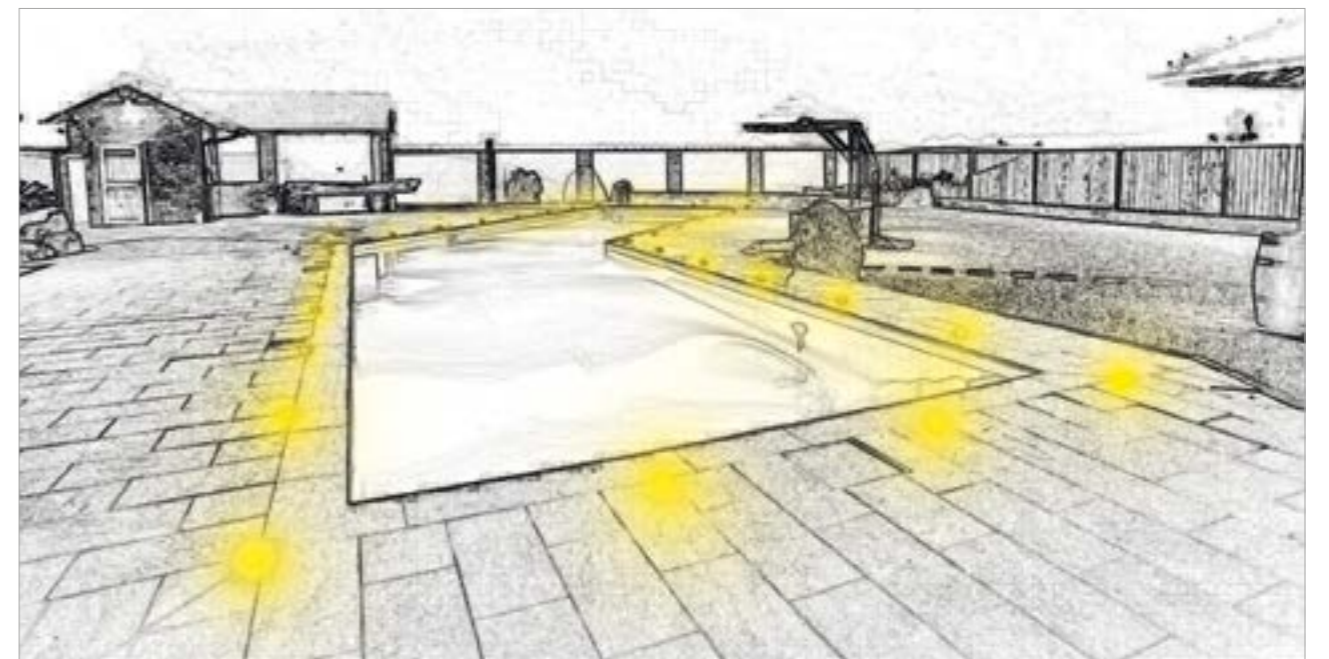
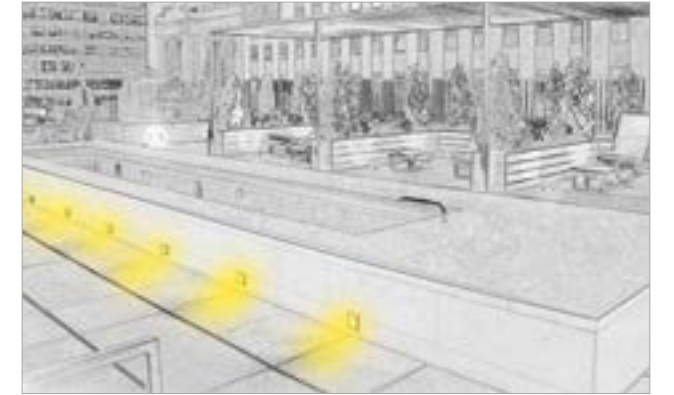
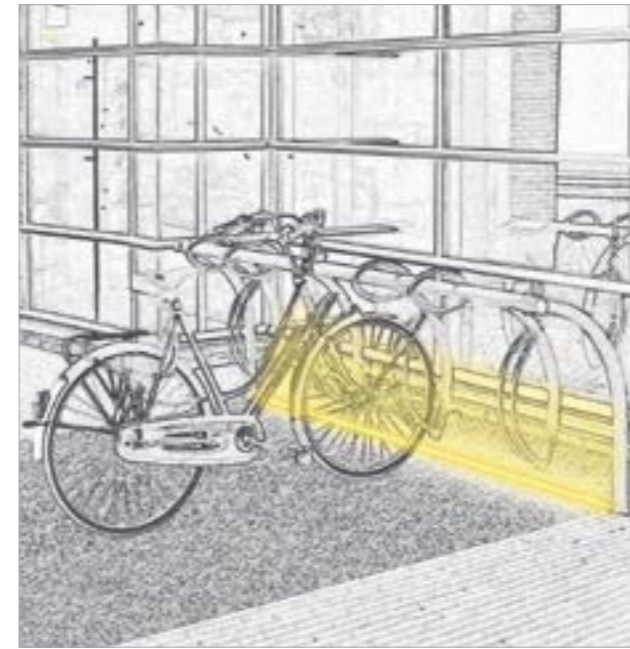



KEPI

design: **U.T. EGOLUCE**

Lampada da esterno (IP 65) a luce asimmetrica.
Struttura in alluminio anodizzato (finitura rinforzata per esterno) o verniciato antracite o verniciato corten. Cavo in neoprene da 250 cm. ALIMENTATORE NON INCLUSO.

Außenleuchte IP65 für asymmetrisches Licht. Gestell aus Aluminium eloxiert (verstärktem Eloxierung für Außenbereich) oder corten lackiert.
Neopren Stromkabel 250 cm.
KONVERTER NICHT INKLUSIV

Outdoor lighting post (IP 65) for asymmetric light, stem in anodized aluminium (reinforced anodizing for outdoor) or painted anthracite finish or painted corten finish. Neoprene cable 250 cm. CONVERTER NOT INCLUDED.

Aparato de iluminación IP65 por luz difusa, soporte en aluminio, acabado anodizado (anodización reforzada para exterior) o pintado corten.
Con inclusión de bolas. Cable en Neopreno 250 cm.
CONVERTIDOR NO INCLUIDO

Poteau (IP65) avec émission asymétrique, structure en aluminium en finition anodisée (anodisation renforcée pour extérieur) ou vernie corten.
Câble en Néoprène 250 cm.
CONVERTISSEUR PAS INCLUS.

Уличный светильник рассеянного света с классом защиты IP65. Корпус из анодированного алюминия (усиленное анодирование для улицы).
С кабелем из неопрена длиной 250 см. Б ЕЗ КОНВЕРТЕРА.

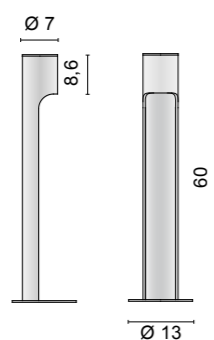

3502 Kepi

- .03** Grigio - Grey
- .34** Verniciato corten - Painted corten finishing
- .39** Verniciato antracite - Painted anthracite finishing

Color temperature	Light sources	lm
W 4000K	LED 17,3V 350mA (6,1W)	972lm
WW 3000K	LED 17,3V 350mA (6,1W)	822lm

1,60 Kg



.03 Grigio - Grey



.34 Verniciato corten
Painted corten finishing



.39 Verniciato antracite
Painted anthracite finishing

Accessori - Accessories



0246
Cassaforma drenante +
plate con viti d'acciaio
Draining junction +
plate with steel screws



0243
Connettore stagno
IP Connector

Cod.	Drivers ON/OFF		IP67 drivers
	0125 350mA	0128 350mA	0031/IP 350mA
3202	1	1-2	1

Solo collegamento in serie - Only serial connection



Outdoor

VISION 1

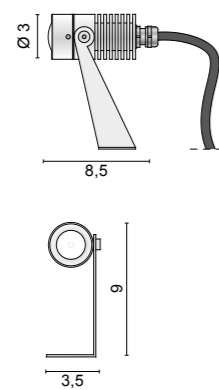

4510 Vision 1

.45 Alluminio anodizzato
Aluminium anodized

Color temperature	Optics	Light sources	lm
/W 4000K	/11 /25 /45	LED max 2W 500mA	209lm
/WW 3000K	/11 /25 /45	LED max 2W 500mA	199lm

IP 67

0,30 Kg

Versione ETL disponibile a richiesta.
ETL version available upon request.

VISION 3

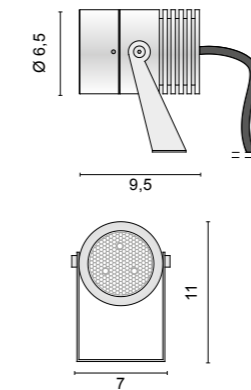

4511 Vision 3

.45 Alluminio anodizzato
Aluminium anodized

Color temperature	Optics	Light sources	lm
/W 4000K	/10 /25 /40	POWER LED max 3x2W 500mA	627lm
/WW 3000K	/10 /25 /40	POWER LED max 3x2W 500mA	597lm

IP 67

0,9 Kg

Versione ETL disponibile a richiesta.
ETL version available upon request.



VISION 3 COB

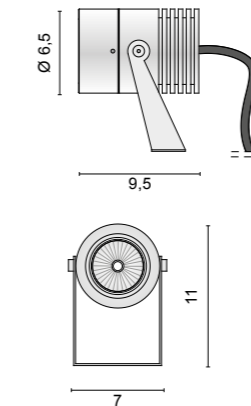

4555 Vision 3 COB

.45 Alluminio anodizzato
Aluminium anodized

Color temperature	Optics	Light sources	lm
/W 4000K	/25 /42	COB LED 8,9W 17,8V 500mA	1353lm
/WW 3000K	/25 /42	COB LED 8,9W 17,8V 500mA	1303lm

IP 67

0,9 Kg

Versione ETL disponibile a richiesta.
ETL version available upon request.

Accessori - Accessories



0247
Picchetto
Stake



0243
Connettore stagno
IP Connector

Cod.	Drivers ON/OFF			IP67 drivers		DIMMABLE drivers			
	0125 350mA	0128 350mA	0127 500mA	0031/IP 350mA	0143/IP 500mA	0141/DIM PUSH - 1...10V	0141/DALI DIM DALI	0145/DALI DIM DALI	0145 DIM
4510	1-6	1-10	1-6	1-10	1-7	1-12	1-12	1-21	1-21

Solo collegamento in serie - Only serial connection

Accessori - Accessories



0248
Picchetto
Stake



0243
Connettore stagno
IP Connector

Cod.	Drivers ON/OFF				IP67 drivers		DIMMABLE drivers				LED emergency unit
	0125 350mA	0128 350mA	0127 500mA	0147/COB 500mA	0031/IP 350mA	0143/IP 500mA	0141/DIM PUSH - 1...10V	0141/DALI DIM DALI	0145/DALI DIM DALI	0145 DIM	0115/EM Inverter + Battery + LED indicator
4511	1-2	1-3	1-2	NO	1-3	1-2	1-6	1-6	1-6	1-6	NO
4555	NO	NO	NO	1-2	NO	1	1-2	1-2	1-3	1-3	1

Solo collegamento in serie - Only serial connection

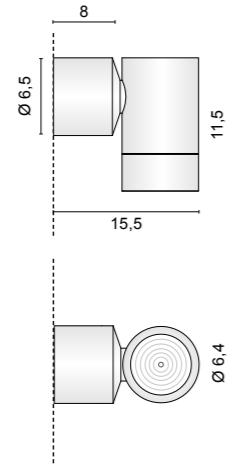

4559 Geo monoemissione

.45 Alluminio anodizzato - Aluminium anodized

Color temperature	Optics	Light sources	lm
<i>NW</i> 4000K	/17 /35	LED 4,5W	440lm
<i>MW</i> 3000K	/17 /35	LED 4,5W	400lm

1,20 Kg

Outdoor

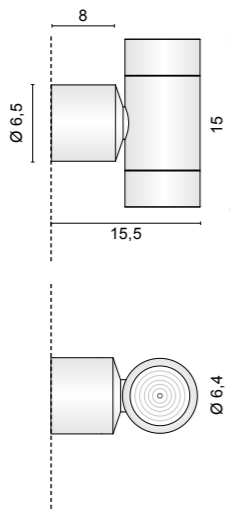

4560 Geo biemissione

.45 Alluminio anodizzato - Aluminium anodized

Color temperature	Optics	Light sources	lm
<i>NW</i> 4000K	/17 /35	LED 9W	880lm
<i>MW</i> 3000K	/17 /35	LED 9W	800lm

1,40 Kg



Outdoor



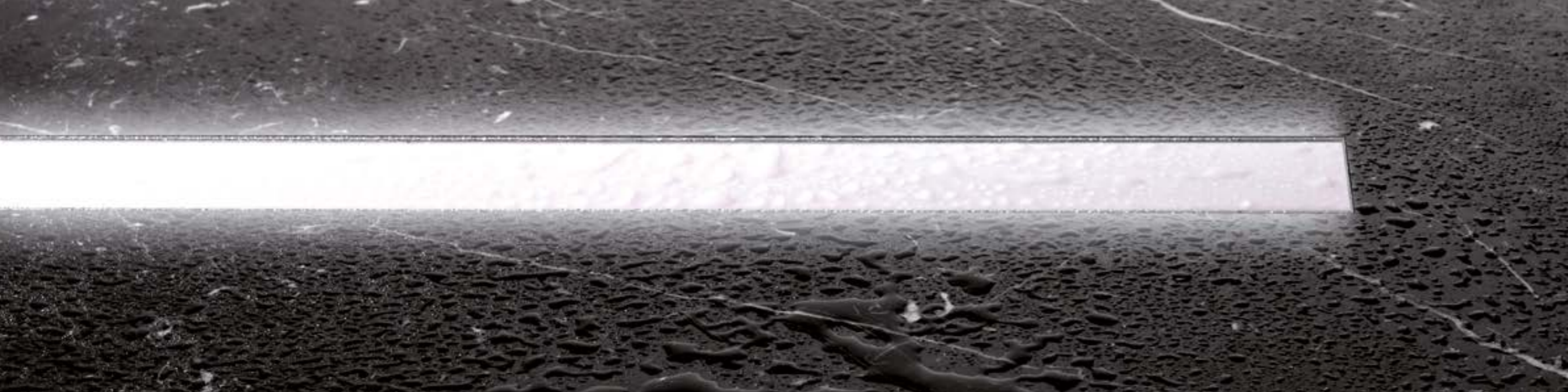

SPOOK design: U.T. EGOLUCE

Linea luminosa LED calpestabile IP67 in metacrilato coestruso trasparente ed opalino. Casseforme modulari in alluminio anodizzato (anodizzazione rinforzata per esterni). Installazione a pavimento o parete con possibilità di comporre linee luminose continue. Versione ETL disponibile a richiesta

Begehbarer LED Einbaulinie IP67, Struktur aus transparentem und opalisiertem fließgepresstem Methakrylat. Modularen Einbaugehäuse aus Aluminium (verstärktem Eloxierung für Außenbereich) für wand-oder Bodeninsetzung. Montage als endlose Linearsystem möglich.

LED linear walk-over IP67 in coextruded transparent and opal methacrylate. Modular anodized aluminium blind boxes (reinforced anodizing for outdoor). To be installed into floor or wall and possibility to compose endless light lines. ETL version available upon request

Linea luminosa LED pisabile IP67 en metacrilato coextruso transparente y opal. Cajetin modular en aluminio anodizado (anodización reforzada para exterior). Instalación a suelo o pared y posibilidad de realizar líneas luminosas continuas.

Ligne lumineuse LED piétonnable IP67 en méthacrylate coextru transparent et opale. Boitiers modulaires en aluminium anodisé (anodisation renforcée pour l'extérieur). Installation au plancher ou cloison avec la possibilité d'obtenir des lignes lumineuses continues. Version ETL disponible sur demande

Светодиодны й встраиваемый в грунт профиль для пешеходных зон, степень защиты IP67, алюминий, прозрачный или матовый диффузор. Монтажный корпус из алюминия с усиленным анодированием для наружного использования. Для встраивания в пол или стену, можно составить бесконечную линию.



Outdoor

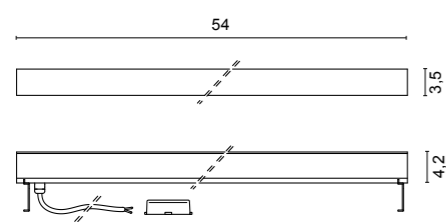

6417 Spook

.01 Bianco - White

Color temperature Light sources lm

/W 4000K LED 24V 4,5W 600lm

/WW 3000K LED 24V 4,5W 600lm

IP67 IK10 0,8 Kg

Versione ETL disponibile a richiesta.
ETL version available upon request.

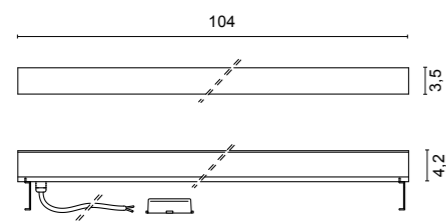

6418 Spook

.01 Bianco - White

Color temperature Light sources lm

/W 4000K LED 24V 8,9W 1200lm

/WW 3000K LED 24V 8,9W 1200lm

IP67 IK10 1,6 Kg

Versione ETL disponibile a richiesta.
ETL version available upon request.

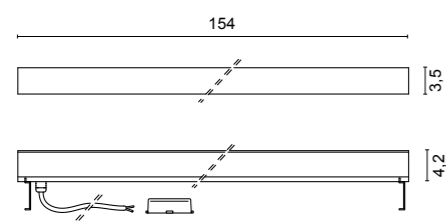

6419 Spook

.01 Bianco - White

Color temperature Light sources lm

/W 4000K LED 24V 13,4W 1800lm

/WW 3000K LED 24V 13,4W 1800lm

IP67 IK10 2,3 Kg

Versione ETL disponibile a richiesta.
ETL version available upon request.

cm.	watt	3000K (WW)	lm	4000K (W)	lm
14	0,9W	A6417.01/14/WW	120	A6417.01/14/W	120
24	1,8W	A6417.01/24/WW	240	A6417.01/24/W	240
34	2,7W	A6417.01/34/WW	360	A6417.01/34/W	360
44	3,6W	A6417.01/44/WW	480	A6417.01/44/W	480
54	4,5W	6417.01/WW *	600	6417.01/W *	600
64	5,3W	A6417.01/64/WW	720	A6417.01/64/W	720
74	6,2W	A6417.01/74/WW	840	A6417.01/74/W	840
84	7,1W	A6417.01/84/WW	960	A6417.01/84/W	960
94	8W	A6417.01/94/WW	1080	A6417.01/94/W	1080
104	8,9W	6418.01/WW *	1200	6418.01/W *	1200
114	9,8W	A6417.01/114/WW	1320	A6417.01/114/W	1320
124	10,7W	A6417.01/124/WW	1440	A6417.01/124/W	1440
134	11,6W	A6417.01/134/WW	1560	A6417.01/134/W	1560
144	12,5W	A6417.01/144/WW	1680	A6417.01/144/W	1680
154	13,4W	6419.01/WW *	1800	6419.01/W *	1800

CUSTOM SIZE

Tabella lunghezze disponibili a richiesta.
Le misure si riferiscono alle lunghezze totali delle lampade.

Table of available lengths on request.
Measures are referred to complete fixtures including closing heads.

* Articolo standard a catalogo - Standard catalogue item

Drivers **ON/OFF**

Cod.	0155	0156	0160	0157	0161/100	0162
	24V-13W	24V-25W	24V-50W	24V-75W	24V-100W	24V-150W

IP67 drivers

Cod.	0033/IP	0034/IP	0036/IP
	24V-14,4W	24V-70W	24V-160W

DIMMABLE drivers

Cod.	0110/DIM	0717/DIM60	0717/DIM100
	12/24V	24V-60W	24V-100W

LED emergency unit

0115/EM
Inverter + Battery + LED indicator

Solo collegamento in parallelo. - Only parallel connection.



Outdoor

Esempio di configurazione - Configuration example

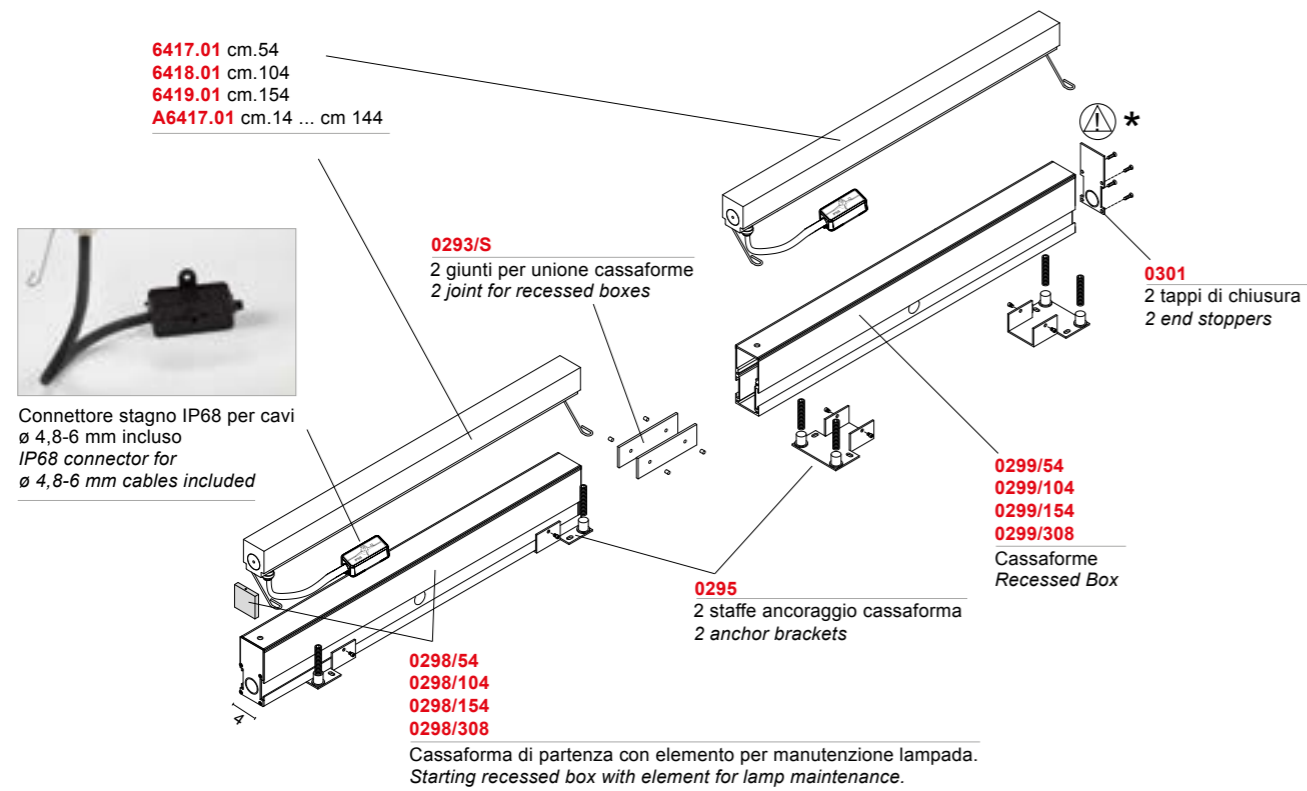

*Il tappo di chiusura è fornito con la cassaforma di partenza. *The end stopper is included in the starting box.*



Accessori - Accessories



0298
 Cassaforma di partenza con tappi ed elemento per manutenzione lampada.
 Starting recessed box with caps and element for lamp maintenance.

/54	55,1 x 4 x 9cm	0,9kg
/104	105,1 x 4 x 9cm	1,7kg
/154	155,1 x 4 x 9cm	2,6kg
/308	309,1 x 4 x 9cm	5,7kg



0299
 Cassaforma.
 I tappi di chiusura sono forniti con la cassaforma di partenza.
 Recessed box.
 The end stoppers are included in the starting box.

/54	54,1 x 4 x 9cm	0,8kg
/104	104,1 x 4 x 9cm	1,6kg
/154	154,1 x 4 x 9cm	2,5kg
/308	308,1 x 4 x 9cm	5,6kg



0295
 2 staffe ancoraggio per cassaforma
 2 anchor brackets for recessed box



0293/S
 2 giunti per unione cassaforme
 2 joints for recessed box



0301
 2 tappi di chiusura per cassaforma
 2 end stoppers for recessed box





WANDA design: U.T. EGOLUCE

Barra luminosa orientabile a LED IP67 in metacrilato trasparente coestruso anti-UV e terminali in acciaio inox AISI 316L .
Cavo in neoprene da 100 cm.
Applicazione a parete o a soffitto.
Disponibile in diverse lunghezze fino a 3 metri.
Versione ETL disponibile a richiesta.

Verstellbare Linear LED System IP67 aus transparentem fließgeschstem Methakrylat mit UV schutz und Endteile aus Edelstahl AISI316L.
Inkl. Neoprene Stromkabel 100 cm.
Zur Montage als Wand oder Deckenleuchte ist in verschiedene Länge bis Max. 3 Meter verfügbar.

Adjustable LED profile IP67 in coextruded anti-UV transparent methacrylate and AISI 316L stainless steel terminals.
Neoprene cable 100 cm. Wall or ceiling installation possible. Available in different lengths up to 3 meters. ETL version available upon request.

Barra luminosa orientabile a LED IP67 en metacrilato claro coextruso anti-UV y terminales de acero inox AISI 316L.
Cable de neopreno 100 cm. Para montaje a pared y techo es disponible en varias larguras hasta 3 metros.

Barre lumineuse orientable à LED IP67 en méthacrylate transparent coextru anti-UV et terminales en acier inox AISI 316L . Câble en néoprène 100 cm.
Installable en applique ou au plafond.
Disponibles en plusieurs longueurs jusqu'à 3 mètres.
Version ETL disponible sur demande.

Поворотный профиль со степенью защиты IP67 из прозрачного метакрилата без УФ, концевые детали из нержавеющей стали. Кабель из неопрена 100 см. Для стены или потолка. В разных размерах до 3 метров длиной.

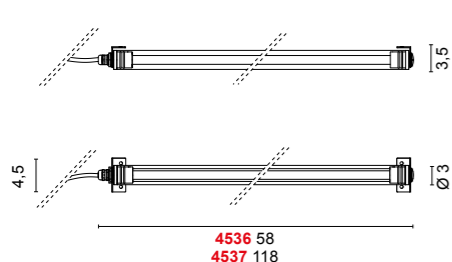

4536 Wanda
 .33 Acciaio satinato - Matt steel

Color temperature	Light sources	lm
/W 4000K	LED 24V 7,5W	920m
/WW 3000K	LED 24V 7,5W	825lm
/XW 2700K	LED 24V 7,5W	780lm

IP67

Versione ETL disponibile a richiesta.
 ETL version available upon request.

0,5 Kg

4537 Wanda
 .33 Acciaio satinato - Matt steel

Color temperature	Light sources	lm
/W 4000K	LED 24V 16,5W	2024lm
/WW 3000K	LED 24V 16,5W	1815lm
/XW 2700K	LED 24V 16,5W	1716lm

IP67

Versione ETL disponibile a richiesta.
 ETL version available upon request.

1 Kg

WANDA RGB

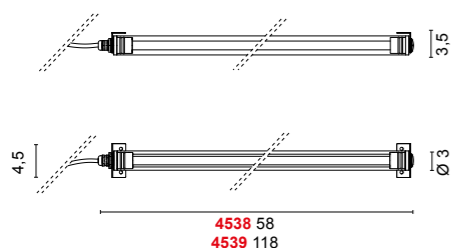

4538 Wanda RGB
 .33 Acciaio satinato - Matt steel

Light sources
 LED 7,2W 24V

IP67

Versione ETL disponibile a richiesta.
 ETL version available upon request.

0,5 Kg

4539 Wanda RGB
 .33 Acciaio satinato - Matt steel

Light sources
 LED 7,2W 24V

IP67

Versione ETL disponibile a richiesta.
 ETL version available upon request.

1 Kg



CUSTOM SIZE

Tabella lunghezze disponibili. Le misure si riferiscono alle lunghezze totali delle lampade.
 Table of available lengths. Measures are referred to complete fixtures including closing heads.

cm.	watt	2700K (XW)	lm	3000K (WW)	lm	4000K (W)	lm	RGB
18	1,5W	A4536.33/18/XW	152	A4536.33/18/WW	165	A4536.33/18/W	184	A4536.33/18RGB
28	3W	A4536.33/28/XW	312	A4536.33/28/WW	330	A4536.33/28/W	368	A4536.33/28RGB
38	4,5W	A4536.33/38/XW	468	A4536.33/38/WW	495	A4536.33/38/W	552	A4536.33/38RGB
48	6W	A4536.33/48/XW	624	A4536.33/48/WW	660	A4536.33/48/W	736	A4536.33/48RGB
58	7,5W	4536.33/XW *	780	4536.33/WW *	825	4536.33/W *	920	4538.33 *
68	9W	A4536.33/68/XW	936	A4536.33/68/WW	990	A4536.33/68/W	1104	A4536.33/68RGB
78	10,5W	A4536.33/78/XW	1092	A4536.33/78/WW	1155	A4536.33/78/W	1288	A4536.33/78RGB
88	12W	A4536.33/88/XW	1248	A4536.33/88/WW	1320	A4536.33/88/W	1472	A4536.33/88RGB
98	13,5W	A4536.33/98/XW	1404	A4536.33/98/WW	1485	A4536.33/98/W	1656	A4536.33/98RGB
108	15W	A4536.33/108/XW	1560	A4536.33/108/WW	1650	A4536.33/108/W	1840	A4536.33/108RGB
118	16,5W	4537.33/XW *	1716	4537.33/WW *	1815	4537.33/W *	2024	4539.33 *
128	18W	A4536.33/128/XW	1872	A4536.33/128/WW	1980	A4536.33/128/W	2208	A4536.33/128RGB
138	19,5W	A4536.33/138/XW	2028	A4536.33/138/WW	2145	A4536.33/138/W	2392	A4536.33/138RGB
148	21W	A4536.33/148/XW	2184	A4536.33/148/WW	2310	A4536.33/148/W	2576	A4536.33/148RGB
158	22,5W	A4536.33/158/XW	2340	A4536.33/158/WW	2475	A4536.33/158/W	2760	A4536.33/158RGB
168	24W	A4536.33/168/XW	2496	A4536.33/168/WW	2640	A4536.33/168/W	2944	A4536.33/168RGB
178	25,5W	A4536.33/178/XW	2652	A4536.33/178/WW	2805	A4536.33/178/W	3128	A4536.33/178RGB
188	27W	A4536.33/188/XW	2808	A4536.33/188/WW	2970	A4536.33/188/W	3312	A4536.33/188RGB
198	28,5W	A4536.33/198/XW	2964	A4536.33/198/WW	3135	A4536.33/198/W	3496	A4536.33/198RGB
208	30W	A4536.33/208/XW	3120	A4536.33/208/WW	3300	A4536.33/208/W	3680	A4536.33/208RGB
218	31,5W	A4536.33/218/XW	3276	A4536.33/218/WW	3465	A4536.33/218/W	3864	A4536.33/218RGB
228	33W	A4536.33/228/XW	3432	A4536.33/228/WW	3630	A4536.33/228/W	4048	A4536.33/228RGB
238	34,5W	A4536.33/238/XW	3588	A4536.33/238/WW	3795	A4536.33/238/W	4232	A4536.33/238RGB
248	36W	A4536.33/248/XW	3744	A4536.33/248/WW	3960	A4536.33/248/W	4416	A4536.33/248RGB
258	37,5W	A4536.33/258/XW	3900	A4536.33/258/WW	4125	A4536.33/258/W	4600	A4536.33/258RGB
268	39W	A4536.33/268/XW	4056	A4536.33/268/WW	4290	A4536.33/268/W	4784	A4536.33/268RGB
278	40,5W	A4536.33/278/XW	4212	A4536.33/278/WW	4455	A4536.33/278/W	4968	A4536.33/278RGB
288	42W	A4536.33/288/XW	4368	A4536.33/288/WW	4620	A4536.33/288/W	5152	A4536.33/288RGB
298	43,5W	A4536.33/298/XW	4524	A4536.33/298/WW	4785	A4536.33/298/W	5336	A4536.33/298RGB

* Articolo standard a catalogo - Standard catalogue item



Pixeling free

Il nuovo circuito 180 LED/mt. annulla l'effetto puntiforme garantendo una luce continua e uniforme.

New LED strip 180 LED /mt. cancels the pixeling effect guaranteeing a continuous and uniform light.

Drivers ON/OFF

Cod.	0155	0156	0160	0157	0161/100	0162
	24V-13W	24V-25W	24V-50W	24V-75W	24V-100W	24V-150W

IP67 drivers

Cod.	0033/IP	0034/IP	0036/IP
	24V-14,4W	24V-70W	24V-160W

DIMMABLE drivers

Cod.	0110/DIM	0717/DIM60	0717/DIM100
	12/24V	24V-60W	24V-100W

RGB drivers

Cod.	0164	0167
	120W	22W
	IN:230V - OUT: 3x24V	

Driver RGB Casambi

Cod.	0164/CASA
	120W
	IN:230V - OUT: 3x24V

Cod.	0163	0165	0166
	IR Sensor	IR Remote controller	Sinc Cable

Solo collegamento in parallelo. - Only parallel connection.



ZEPPELIN

design: **U.T. EGOLUCE**

Serie di faretti da incasso calpestabili (IP 67) con flangia in acciaio INOX AISI 316L, dissipatore in alluminio e cavo in neoprene da 30 cm. Disponibili in versioni tonde e quadrate. Montaggio con cassaforma o in cartongesso con apposito accessorio. Versione ETL disponibile a richiesta

Series of walkover recessed spots (IP 67) with frame in stainless steel AISI 316L, heat sink in aluminum and neoprene cable 30 cm. Available in round and square versions. Mounting with recessed box or in plasterboards by means of a specific accessory. ETL version available upon request

Serie de spots encastrable piétinable (IP67). Cadre en acier INOX AISI316L et dissipateur en aluminium. Câble en néoprène de 30 cm. Verre de protection satiné. Montage avec boîte d'encastrement ou dans le placo-plâtre avec accessoire spécifique. Version ETL disponible sur demande

Begehbarer Einbaustrahler (IP67). Rahme aus rostfreier Stahl AISI316L und Kühlkörper aus Aluminium. Neopren Stromkabel 30 cm. inbegriffen. Satiniertem Schutzglas. Montage mit Einbaugehäuse oder im Gipskarton mit spezifischem Zubehör.

Serie de focos pisables para empotrar (IP67) con brida en acero INOX AISI316L y dissipador de calor en aluminio. Cable de neopreno de 30 cm. Cristal de protección satinado. Montaje con cajetín o, en paneles de yeso, utilizando el accesorio específico.

Встроенные светильники из нержавеющей стали марки AISI316L для пешеходных зон. IP67. С радиатором для отвода тепла и кабелем из неопрена 30 см. Круглые или квадратные. Монтируется с монтажной коробкой или в гипскартон с помощью специального аксессуара.

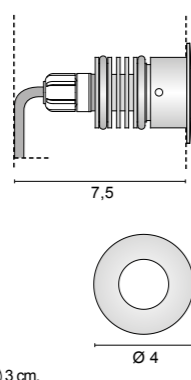

6348 Zeppelin tondo

.33 Acciaio satinato - Matt steel
Inox AISI 316L

Color temperature	Light sources	lm
/W 4000K	LED max 2W 500mA	209lm
/WW 3000K	LED max 2W 500mA	199lm
/XW 2700K	LED max 2W 500mA	189lm

IP67 3000h 10000h 73° 0,08 Kg

Versione ETL disponibile a richiesta.
ETL version available upon request.

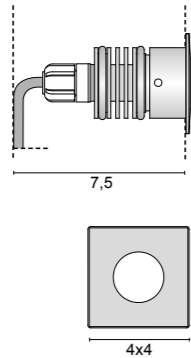

6349 Zeppelin quadro

.33 Acciaio satinato - Matt steel
Inox AISI 316L

Color temperature	Light sources	lm
/W 4000K	LED max 2W 500mA	209lm
/WW 3000K	LED max 2W 500mA	199lm
/XW 2700K	LED max 2W 500mA	189lm

IP67 3000h 10000h 73° 0,10 Kg

Versione ETL disponibile a richiesta.
ETL version available upon request.



Molla per cartongesso inclusa
Spring for plasterboard included

3,2 cm.



Accessori - Accessories



0216
Controcassa in materiale plastico
Plastic box



0220
KIT: cassaforma drenante + Conettore IP
KIT: draining junction + IP connector

Cod.	Drivers ON/OFF			IP67 drivers		DIMMABLE drivers			
	0125 350mA	0128 350mA	0127 500mA	0031/IP 350mA	0143/IP 500mA	0141/DIM PUSH - 1...10V	0141/DALI DIM DALI	0145/DALI DIM DALI	0145 DIM
6348	1-6	1-10	1-6	1-10	1-7	1-12	1-12	1-21	1-21
6349	1-6	1-10	1-6	1-10	1-7	1-12	1-12	1-21	1-21

Solo collegamento in serie - Only serial connection

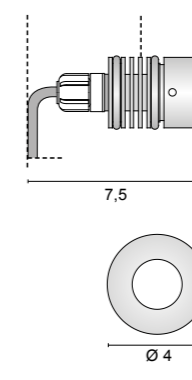

6376 Zeppelin tondo RGB

.33 Acciaio satinato - Matt steel
Inox AISI 316L

Light sources
LED 3x250mA

IP67 1000h 10000h 73° 0,2 Kg

Versione ETL disponibile a richiesta.
ETL version available upon request.

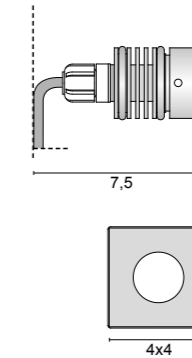

6395 Zeppelin quadro RGB

.33 Acciaio satinato - Matt steel
Inox AISI 316L

Light sources
LED 3x250mA

IP67 1000h 10000h 73° 0,2 Kg

Versione ETL disponibile a richiesta.
ETL version available upon request.



Molla per cartongesso inclusa
Spring for plasterboard included

3,2 cm.

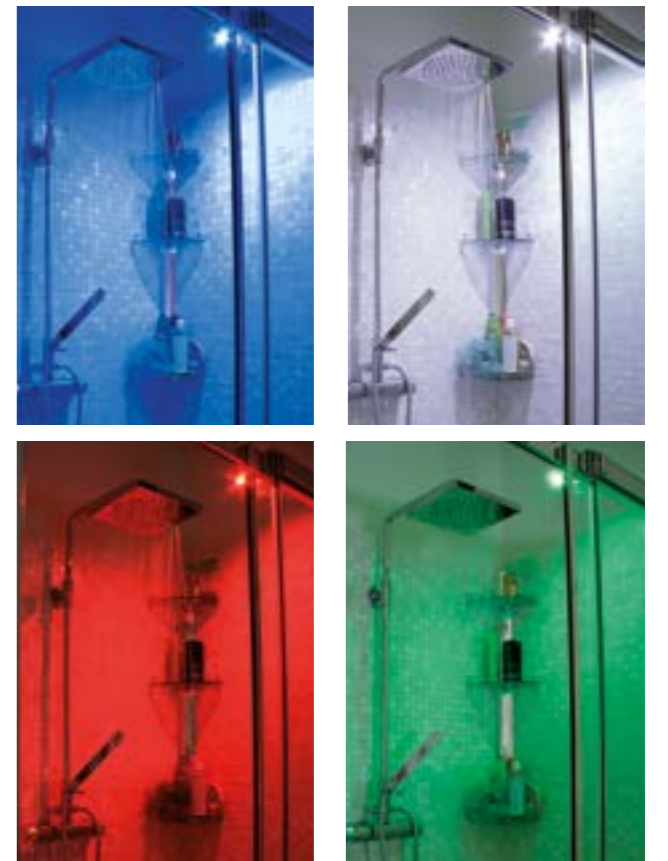

Accessori - Accessories



0216
Controcassa in materiale plastico
Plastic box



0228
Cassaforma drenante
Draining junction

Drivers RGB		Driver RGB Casambi	Converter RGB		0163	0165	0166
0164 120W	0167 22W	0164/CASA 120W	0168	0168	IR Sensor	IR Remote controller	Sinc Cable
IN:230V - OUT: 3x24V		IN:230V - OUT: 3x24V		IN:24V - OUT: 3x250 mA 1-5 Zeppelin RGB			

Solo collegamento in serie - Only serial connection

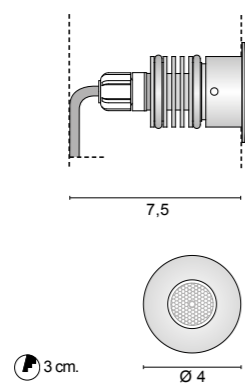

6384 Zeppelin Tondo 25 Plus

.33 Acciaio satinato - *Matt steel*
Inox AISI 316L

Color temperature	Optics	Light sources	lm
<i>W</i> 4000K	<i>/11 /25 /45</i>	LED max 2W 500mA	209lm
<i>MW</i> 3000K	<i>/11 /25 /45</i>	LED max 2W 500mA	199lm
<i>XW</i> 2700K	<i>/11 /25 /45</i>	LED max 2W 500mA	189lm

IP67 30° 3000h 100% 100% R 0,08 Kg

Versione ETL disponibile a richiesta.
ETL version available upon request.

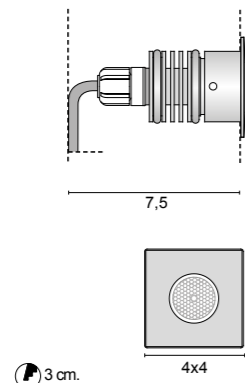

6394 Zeppelin Quadro 25 Plus

.33 Acciaio satinato - *Matt steel*
Inox AISI 316L

Color temperature	Optics	Light sources	lm
<i>W</i> 4000K	<i>/11 /25 /45</i>	LED max 2W 500mA	209lm
<i>MW</i> 3000K	<i>/11 /25 /45</i>	LED max 2W 500mA	199lm
<i>XW</i> 2700K	<i>/11 /25 /45</i>	LED max 2W 500mA	189lm

IP67 30° 3000h 100% 100% R 0,10 Kg

Versione ETL disponibile a richiesta.
ETL version available upon request.



Molla per cartongesso inclusa
Spring for plasterboard included
3,2 cm.

Accessori - Accessories



0216
Controcassa in materiale plastico
Plastic box



0220
KIT: cassafornia drenante + Conettore IP
KIT: draining junction + IP connector

Cod.	Drivers ON/OFF			IP67 drivers		DIMMABLE drivers			
	0125 350mA	0128 350mA	0127 500mA	0031/IP 350mA	0143/IP 500mA	0141/DIM PUSH - 1...10V	0141/DALI DIM DALI	0145/DALI DIM DALI	0145 DIM
6384	1-6	1-10	1-6	1-10	1-7	1-12	1-12	1-21	1-21
6394	1-6	1-10	1-6	1-10	1-7	1-12	1-12	1-21	1-21

Solo collegamento in serie - Only serial connection



Outdoor

Outdoor

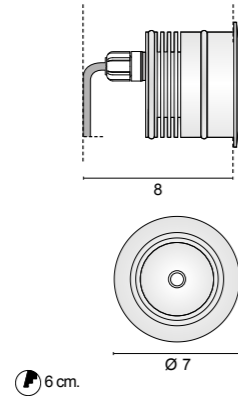

6397 Zeppelin Maxi COB

.33 Acciaio satinato - Matt steel
Inox AISI 316L

Color temperature	Optics	Light sources	lm
/W 4000K	/28 /60	COB LED 8,9W 17,8V 500mA	1553lm
/WW 3000K	/28 /60	COB LED 8,9W 17,8V 500mA	1303lm



0,40 Kg

Versione ETL disponibile a richiesta.
ETL version available upon request.

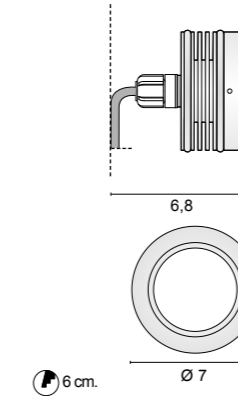

6368 Zeppelin Maxi Tondo

.33 Acciaio satinato - Matt steel
Inox AISI 316L

Color temperature	Light sources	lm
/W 4000K	LED max 3x1W 350mA	453lm
/WW 3000K	LED max 3x1W 350mA	429lm



0,40 Kg

Versione ETL disponibile a richiesta.
ETL version available upon request.

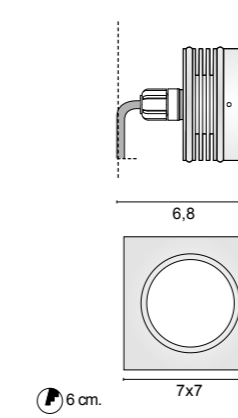

6383 Zeppelin Maxi Quadro

.33 Acciaio satinato - Matt steel
Inox AISI 316L

Color temperature	Light sources	lm
/W 4000K	LED max 3x1W 350mA	453lm
/WW 3000K	LED max 3x1W 350mA	429lm



0,35 Kg

Versione ETL disponibile a richiesta.
ETL version available upon request.



Outdoor

Outdoor

Accessori - Accessories



0230

KIT: cassaforma drenante + Connettore IP
KIT: draining junction + IP connector



0260/C

Molla per installazione in cartongesso
Spring for plasterboard

Cod.	Drivers ON/OFF	IP67 drivers	DIMMABLE drivers			
			0141/DIM	0141/DALI	0145/DALI	0145
4555	500mA 1-2	500mA 1	PUSH - 1...10V 1-2	DIM DALI 1-2	DIM DALI 1-3	DIM 1-3

Solo collegamento in serie - Only serial connection

Accessori - Accessories



0230

KIT: cassaforma drenante + Connettore IP
KIT: draining junction + IP connector



0232

Cassaforma da parete
Wall plastic box



0260

Molla per installazione in cartongesso
Spring for plasterboard

Cod.	Drivers ON/OFF	IP67 drivers	DIMMABLE drivers			
			0141/DIM	0141/DALI	0145/DALI	0145
6368	350mA 1-2	350mA 1-3	PUSH - 1...10V 1-12	DIM DALI 1-12	DIM DALI 1-21	DIM 1-21
6383	350mA 1-2	350mA 1-3	PUSH - 1...10V 1-12	DIM DALI 1-12	DIM DALI 1-21	DIM 1-21

Solo collegamento in serie - Only serial connection

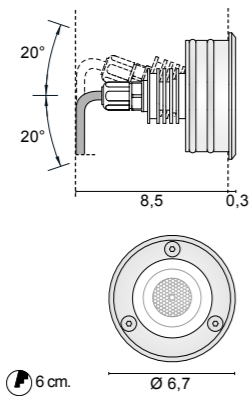

6411 Zeppelin Orientabile

.33 Acciaio satinato - Matt steel
Inox AISI 316L

Color temperature	Optics	Light sources	lm
<i>W</i> 4000K	/11 /25 /45	LED max 2W 500mA	209lm
<i>WW</i> 3000K	/11 /25 /45	LED max 2W 500mA	199lm
<i>XW</i> 2700K	/11 /25 /45	LED max 2W 500mA	189lm

Versione ETL disponibile a richiesta.
ETL version available upon request.

Versione ETL disponibile a richiesta.
ETL version available upon request.

0,40 Kg

Outdoor



Accessori - Accessories



0230
KIT: cassaforma drenante + Connettore IP
KIT: draining junction + IP connector



0232
Cassaforma da parete
Wall plastic box



0238
Molla per installazione in cartongesso
Spring for plasterboard

Cod.	Drivers ON/OFF			IP67 drivers		DIMMABLE drivers			
	0125 350mA	0128 350mA	0127 500mA	0031/IP 350mA	0143/IP 500mA	0141/DIM PUSH - 1...10V	0141/DALI DIM DALI	0145/DALI DIM DALI	0145 DIM
6411	1-6	1-10	1-6	1-10	1-7	1-12	1-12	1-21	1-21

Solo collegamento in serie - Only serial connection



Outdoor

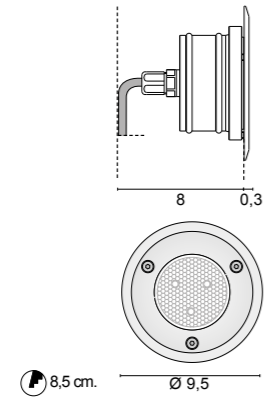

6371 Tris
 .33 Acciaio satinato - Matt steel
 Inox AISI 316L

Color temperature	Optics	Light sources	lm
/W 4000K	/10 /25 /40	LED max 3x2W 500mA	627lm
/WW 3000K	/10 /25 /40	LED max 3x2W 500mA	597lm

IP67 30 cm 100 kg 0,40 Kg

Versione ETL disponibile a richiesta.
 ETL version available upon request.

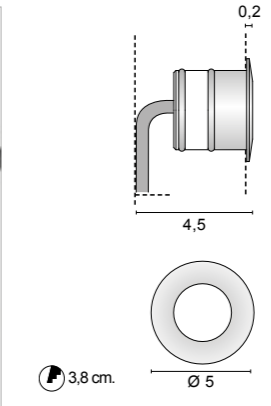

6388 Soft
 .33 Acciaio satinato - Matt steel
 Inox AISI 316L

Color temperature	Light sources
/W 4000K	LED 1,5W 12V
/WW 3000K	LED 1,5W 12V

IP67 30 cm 100 kg 0,11 Kg

Versione ETL disponibile a richiesta.
 ETL version available upon request.

Outdoor

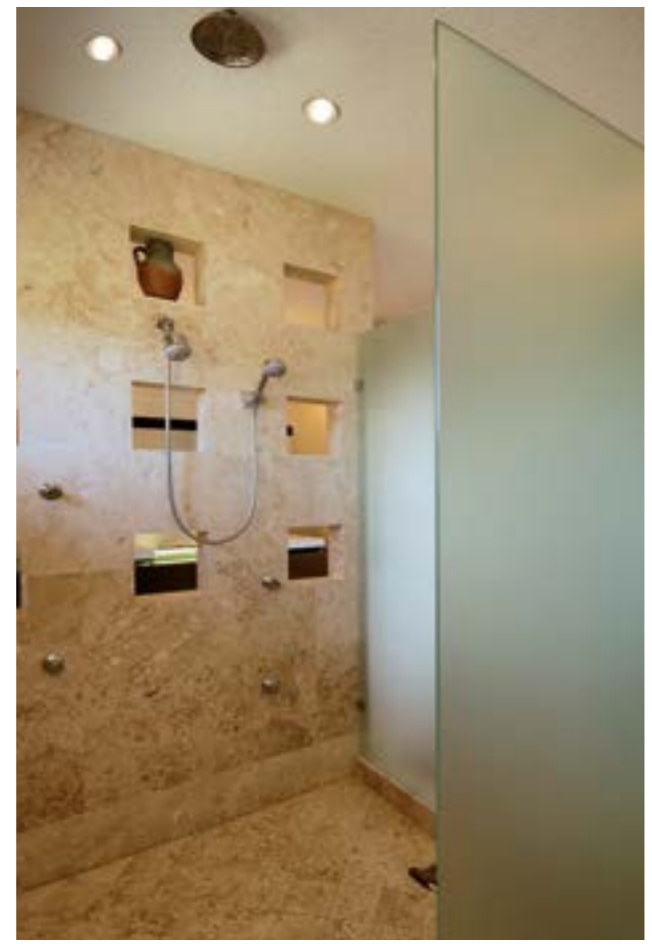

Outdoor



Accessori - Accessories



0231
 KIT: cassaforma drenante + Connettore IP
 KIT: draining junction + IP connector



0235
 Cassaforma da parete
 Wall plastic box



0243
 Connettore stagno
 IP Connector



0233
 Molla per installazione in cartongesso
 Spring for plasterboard

Drivers ON/OFF			IP67 drivers		DIMMABLE drivers				
Cod.	0125	0128	0127	0031/IP	0143/IP	0141/DIM	0141/DALI	0145/DALI	0145
	350mA	350mA	500mA	350mA	500mA	PUSH - 1...10V	DIM DALI	DIM DALI	DIM
6371	1-2	1-3	1-2	1-3	1-2	1-6	1-6	1-6	1-6

Solo collegamento in serie - Only serial connection

Accessori - Accessories



0217
 Controcassa in materiale plastico
 Plastic box



0250
 KIT: cassaforma drenante + Connettore IP
 KIT: draining junction + IP connector

Drivers ON/OFF		IP67 drivers	DIMMABLE drivers	
Cod.	0159	0036/IP	0129	0129/DALI
	12V - 25W	12V - 14,4W	Multi power dimmable driver	Multi power DALI dimmable driver
6388	1-15	1-8	1-6	1-6

Solo collegamento in parallelo - Only parallel connection

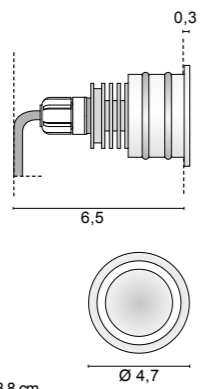

6389 Cerchio

.33 Acciaio satinato - Matt steel
Inox AISI 316L

Color temperature	Light sources	lm
/B LED BLU	LED max 2W 500mA	
/W 4000K	LED max 2W 500mA	209lm
/WW 3000K	LED max 2W 500mA	199lm

IP67 100cm 200kg R 0,20 Kg

Versione ETL disponibile a richiesta.
ETL version available upon request.

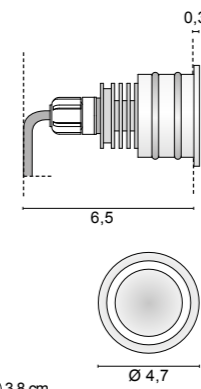

6390 Cerchio RGB

.33 Acciaio satinato - Matt steel
Inox AISI 316L

Light sources
LED 3x250mA

IP67 100cm 200kg R 0,30 Kg

Versione ETL disponibile a richiesta.
ETL version available upon request.



Molla per cartongesso inclusa
Spring for plasterboard included
4 cm.



.33/W **.33/WW** **.33/B**



Molla per cartongesso inclusa
Spring for plasterboard included
4 cm.



Outdoor



Outdoor

Accessori - Accessories



0217
Controcassa in materiale plastico
Plastic box



0250
KIT: cassaforma drenante + Connettore IP
KIT: draining junction + IP connector



Accessori - Accessories



0217
Controcassa in materiale plastico
Plastic box



0251
Cassaforma drenante
Draining junction

Cod.	Drivers ON/OFF			IP67 drivers		DIMMABLE drivers			
	0125 350mA	0128 350mA	0127 500mA	0031/IP 350mA	0143/IP 500mA	0141/DIM PUSH - 1...10V	0141/DALI DIM DALI	0145/DALI DIM DALI	0145 DIM
6389	1-6	1-10	1-6	1-10	1-7	1-12	1-12	1-21	1-21

Solo collegamento in serie - Only serial connection

Drivers RGB		Driver RGB Casambi	Converter RGB	0163	0165	0166
0164 120W	0167 22W	0164/CASA 120W	0168 IN:24V - OUT: 3x250 mA 1-5 Cerchio RGB	IR Sensor	IR Remote controller	Sinc Cable
IN:230V - OUT: 3x24V		IN:230V - OUT: 3x24V				

Solo collegamento in serie - Only serial connection

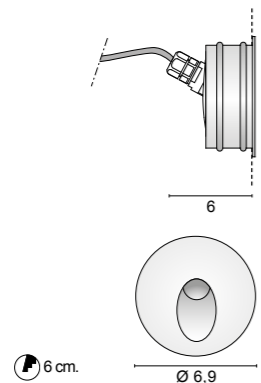

6387 Step Tondo

- .01 Bianco - White
- .45 Alluminio anodizzato - Aluminium anodized

Color temperature	Light sources	lm
/W 4000K	LED max 2W 500mA	209lm
/WW 3000K	LED max2W 500mA	199lm
/XW 2700K	LED max 2W 500mA	189lm

Versione ETL disponibile a richiesta.
ETL version available upon request.

Versione ETL disponibile a richiesta.
ETL version available upon request.

0,24 Kg

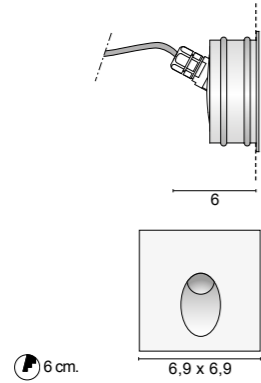

6369 Step Quadro

- .01 Bianco - White
- .45 Alluminio anodizzato - Aluminium anodized

Color temperature	Light sources	lm
/W 4000K	LED max 2W 500mA	209lm
/WW 3000K	LED max2W 500mA	199lm
/XW 2700K	LED max 2W 500mA	189lm

Versione ETL disponibile a richiesta.
ETL version available upon request.

Versione ETL disponibile a richiesta.
ETL version available upon request.

0,24 Kg

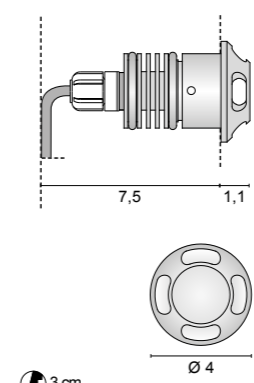

6361 Kross

- .33 Acciaio satinato - Matt steel
- Inox AISI 316L

Color temperature	Light sources	lm
/B LED BLU	LED max 2W 500mA	209lm
/W 4000K	LED max 2W 500mA	209lm
/WW 3000K	LED max 2W 500mA	199lm

Versione ETL disponibile a richiesta.
ETL version available upon request.

Versione ETL disponibile a richiesta.
ETL version available upon request.

0,10 Kg



Molla per cartongesso inclusa
Spring for plasterboard included

3,2 cm.

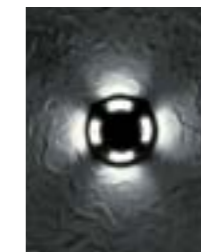

.33/W

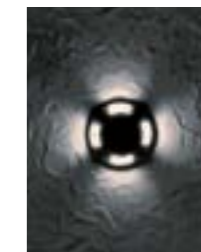

.33/WW

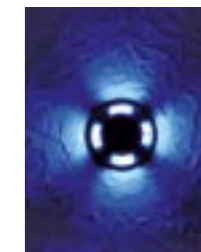

.33/B

Outdoor

Accessori - Accessories



0232
Cassaforma da parete
Wall plastic box



Cod.	Drivers ON/OFF			IP67 drivers		DIMMABLE drivers			
	0125 350mA	0128 350mA	0127 500mA	0031/IP 350mA	0143/IP 500mA	0141/DIM PUSH - 1...10V	0141/DALI DIM DALI	0145/DALI DIM DALI	0145 DIM
6387	1-6	1-10	1-6	1-10	1-7	1-12	1-12	1-21	1-21
6369	1-6	1-10	1-6	1-10	1-7	1-12	1-12	1-21	1-21

Solo collegamento in serie - Only serial connection

Outdoor

Accessori - Accessories



0216
Controcassa in materiale plastico
Plastic box



0220
KIT: cassaforma drenante + Conettore IP
KIT: draining junction + IP connector

Cod.	Drivers ON/OFF			IP67 drivers		DIMMABLE drivers			
	0125 350mA	0128 350mA	0127 500mA	0031/IP 350mA	0143/IP 500mA	0141/DIM PUSH - 1...10V	0141/DALI DIM DALI	0145/DALI DIM DALI	0145 DIM
6361	1-6	1-10	1-6	1-10	1-7	1-12	1-12	1-21	1-21

Solo collegamento in serie - Only serial connection

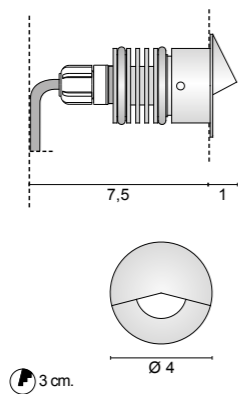

6362 Vista

.33 Acciaio satinato - Matt steel
Inox AISI 316L

Color temperature	Light sources	lm
/W 4000K	LED max 2W 500mA	209lm
/WW 3000K	LED max 2W 500mA	199lm
/XW 2700K	LED max 2W 500mA	189lm

IP67 0,10 Kg

Versione ETL disponibile a richiesta.
ETL version available upon request.



Molla per cartongesso inclusa
Spring for plasterboard included
3,2 cm.

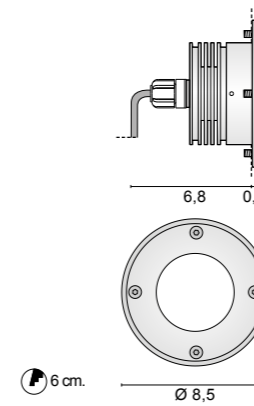

6366 Drive

.33 Acciaio satinato - Matt steel
Inox AISI 316L

Color temperature	Light sources	lm
/W 4000K	LED max 350mA (3x1W)	453lm
/WW 3000K	LED max 350mA (3x1W)	429lm

IP67 0,40 Kg

Versione ETL disponibile a richiesta.
ETL version available upon request.

Faretto carrabile 2000Kg. Driveover recessed spot 2000Kg

Outdoor



Outdoor



Accessori - Accessories



0216
Controcassa in materiale plastico
Plastic box



0220
KIT: cassaforma drenante + Conettore IP
KIT: draining junction + IP connector

Cod.	Drivers ON/OFF			IP67 drivers		DIMMABLE drivers			
	0125 350mA	0128 350mA	0127 500mA	0031/IP 350mA	0143/IP 500mA	0141/DIM PUSH - 1...10V	0141/DALI DIM DALI	0145/DALI DIM DALI	0145 DIM
6362	1-6	1-10	1-6	1-10	1-7	1-12	1-12	1-21	1-21

Solo collegamento in serie - Only serial connection

Accessori - Accessories



0229
KIT: cassaforma drenante + Conettore IP
KIT: draining junction + IP connector

Cod.	Drivers ON/OFF		IP67 drivers	DIMMABLE drivers			
	0125 350mA	0128 350mA	0031/IP 350mA	0141/DIM PUSH - 1...10V	0141/DALI DIM DALI	0145/DALI DIM DALI	0145 DIM
6366	1-2	1-3	1-3	1-6	1-6	1-6	1-6

Solo collegamento in serie - Only serial connection



	<i>pag.</i>
DIMMERAZIONE 1...10V & PUSH PER COB E POWER LED	280
DIMMERAZIONE DALI COB E POWER LED	282
DIMMERAZIONE 12V - 24V PER LED STRIP	284
DIMMERAZIONE 24V PER LED STRIP	286
CONTROLLO RGB SMALL 22W	288
CONTROLLO RGB BIG 120W	290
CONTROLLO RGB PER LED STRIP SMALL 22W	292
CONTROLLO RGB PER LED STRIP SMALL BIG 120W	294
INTERFACCIA DMX	296
CONTROLLO EMERGENZA LED	298
CASAMBI	300
CONTROLLO RGB CASAMBI 120W	301
DRIVER CASAMBI IN CORRENTE 230V	302
ADATTATORI CASAMBI PER BINARI 230V	303

I nostri LED di potenza devono essere alimentati a bassa tensione SOLO con corrente continua e collegati IN SERIE. I nostri alimentatori sono predisposti per questo collegamento.

Our power LED must be powered ONLY with low voltage direct current ONLY IN SERIAL CONNECTION. Our converters are predisposed for this kind of connection.

Nos LED haute puissance doivent être alimentés SEULEMENT en courant direct en baisse tension et installés EN SERIE.

Nos alimentateurs sont prévus pour cette liaison.

Unser power LED sollen NUR mit niedervoltige D.C. Konverter als SERIENVERBINDUNG.

Unsere Konverter sind für diese Verbindungsart vorgesehen.

Nuestros LED de potencia se deben alimentar con baja tensión SOLO con corriente continua y conectados EN SERIE. Nuestros alimentadores están preparados para esta conexión.

Наши светодиоды высокой мощности должны запитываться только постоянным током низкого напряжения только при ПОСЛЕДОВАТЕЛЬНОМ ПОДКЛЮЧЕНИИ.

Наши конвертеры предназначены для такого подключения.

Si consiglia di non superare i 20 mt. nella lunghezza dei cavi tra alimentatore e LED. Collegare tutti i faretti prima di alimentare il circuito.

We recommend not to exceed 20m. of circuit length between converter and LED. Connect all elements before to give tension to the circuit.

On conseille de ne pas dépasser le 20 m. de longueur entre alimentateur et LED. Brancher tous les éléments avant d'alimenter le circuit.

Die Verkabelung zwischen Konverter und LED soll nicht länger als 20 m. sein. Alle di Elemente anschließen vor den Stromkreis einzuschalten.

Se aconseja no exceder en la longitud de los cables entre el alimentador y LED. Conectar todos los focos antes de alimentar el circuito.

Мы рекомендуем, чтобы между конвертером и светильником было не более 20 метров. Подсоединить все светильники прежде, чем подавать напряжение.

Rispettare le polarità nel collegamento elettrico per un corretto funzionamento.

Respect correct polarity when connecting.

Respecter la polarité dans l'installation pour un correct fonctionnement.

Beachten die richtige Polarisation bei der Installation.

Respetar la polaridad en la conexión para una buena instalación.

Соблюдать полярность подсоединений

E' vivamente sconsigliata l'installazione di interruttori tra alimentatore e led.

We strongly recommend to avoid installation of switches between converter and LED.

Ne pas installer des interrupteurs entre alimentateur et LED.

Zwischen Konverter und LED muss Kein Schalter installiert werden.

Es muy aconsejable la instalación de interruptores entre alimentador y LED.

Не монтировать выключатель между конвертером и светильником.

DIMMERAZIONE 1...10V & PUSH PER COB E POWER LED

1...10V & PUSH DIMMING FOR COB AND POWER LED

Alimentatori multipotenza forniti di dip-switch per la selezione della corrente in uscita.

Regolazione della luminosità 0-100% mediante funzione PUSH, interfaccia 1...10V.

Art. 0133 cavetto di sincronizzazione fornito separatamente; max 10 alimentatori sincronizzati, di cui uno solo comandato.

(1 Master + 9 Slaves)

Multi-power drivers supplied with dip-switch for selection of the output current.

Light regulation 0-100% by means of PUSH function, 1...10V interface.

Art. 0133 synchronization cable is sold separately, one commanded master driver can synchronize up to max. 9 slaves

0129

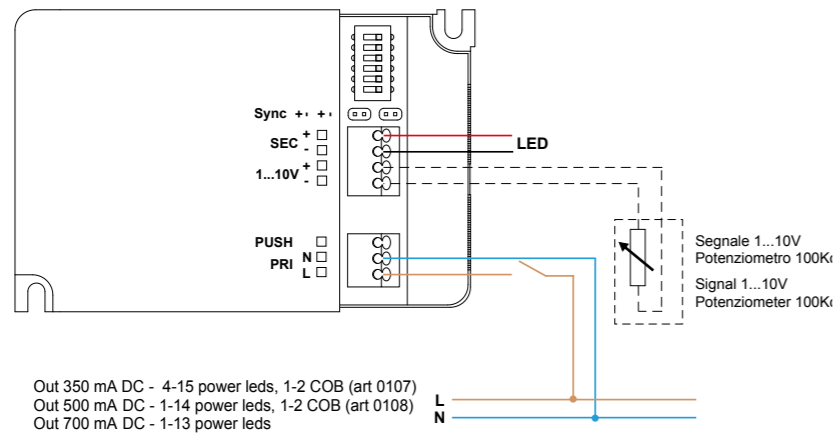

1...10 V

Per la regolazione mediante 1...10V il sistema è provvisto di morsetto specifico attivo.

For light regulation 1...10V the control systems are provided of active terminal connection.

0145

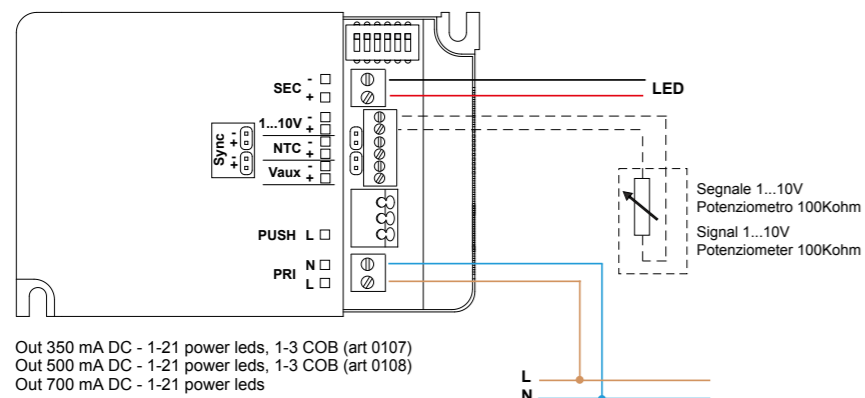

PUSH

Regolazione della luminosità mediante la funzione PUSH

Una breve pressione per accendere e spegnere; una pressione prolungata per aumentare o diminuire l'intensità luminosa. La regolazione si ferma automaticamente ai valori minimi e massimi. Per un nuovo comando accensione, regolazione o spegnimento, rilasciare il pulsante e dare nuovamente il comando desiderato.

Attenzione: Usare solo pulsanti di tipo normalmente aperto privi di spia luminosa incorporata.

Light regulation by means of PUSH function

A short push to turn on and off; a longer push to increase or decrease light intensity. Regulation automatically stops at minimum and maximum values. For another on, regulation or off command, release the push button and give the desired command again.

Attention: only use normally open push buttons with no incorporated warning light.

0129

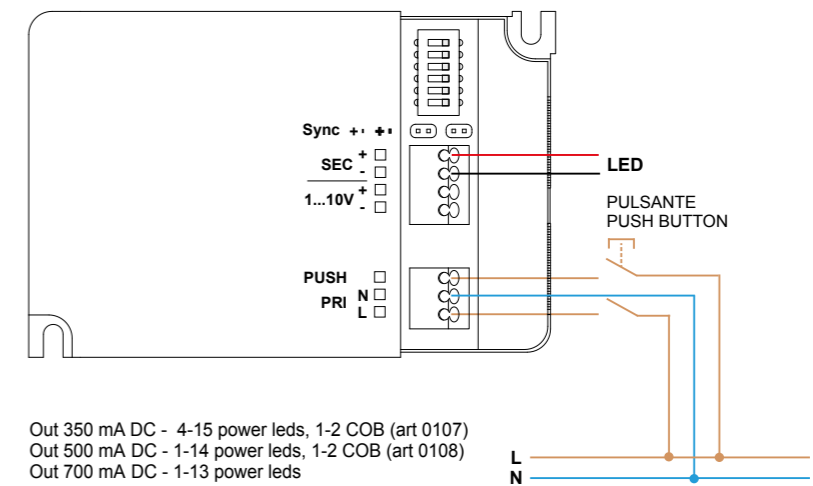

0145

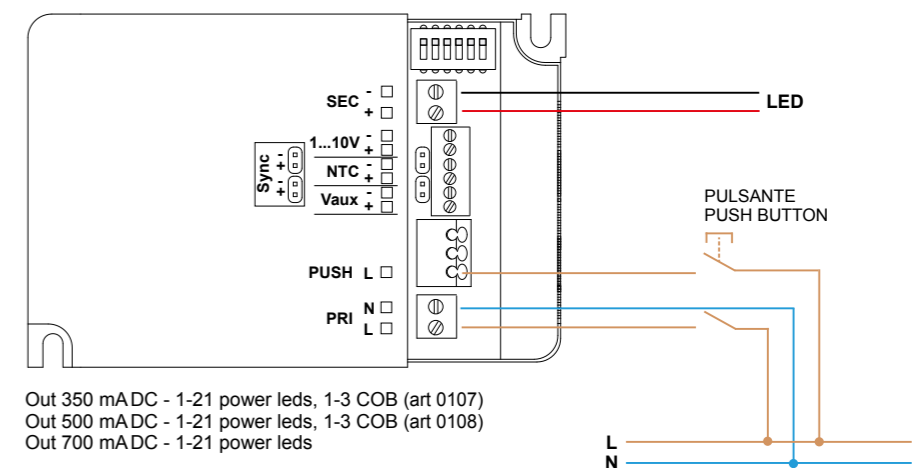

DIMMERAZIONE DALI COB E POWER LED

DALI DIMMING FOR COB AND POWER LED



Alimentatori multipotenza forniti di dip-switch per la selezione della corrente in uscita. Caratteristiche della regolazione DALI (0,5-100%):

- funzione di memoria per scenari o gruppi luminosi
- richiamo di funzioni memorizzate
- compatibilità con interfacce DALI standard

Art. 0133 cavetto di sincronizzazione fornito separatamente; max 10 alimentatori sincronizzati, di cui uno solo comandato.

Multi-power drivers supplied with dip-switch for selection of the output current. Features DALI dimming (0,5-100%):

- memory function for sets or light groups
- recall of stored functions
- compatible with standard DALI interfaces

Art. 0133 synchronization cable is sold separately, one commanded master driver can synchronize up to max. 9 slaves

Technology



0129/DALI

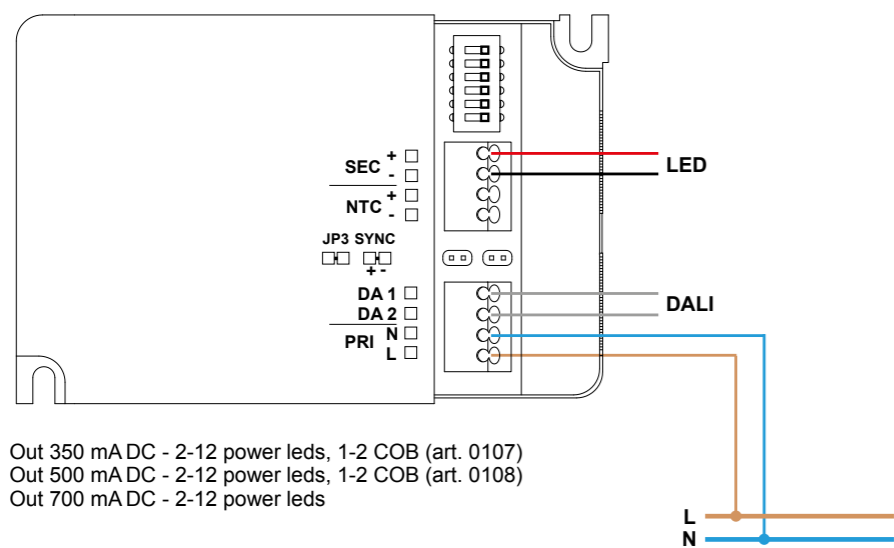

0145/DALI

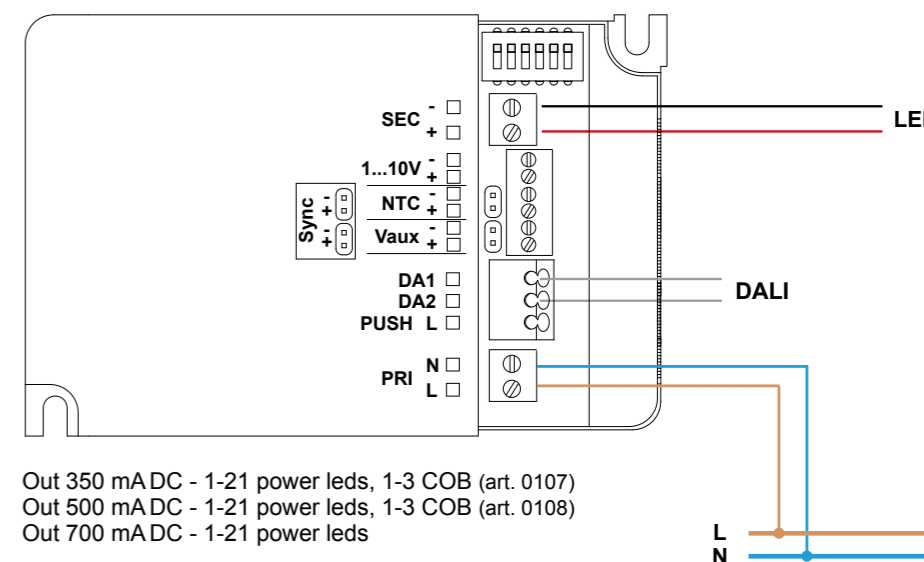

DIMMERAZIONE 12V - 24V PER LED STRIP

DIMMING 12V - 24V FOR LED STRIP

REGOLATORE DI LUMINOSITÀ PER DRIVER LED CON USCITA IN TENSIONE 12-24V DC.

LIGHT DIMMER FOR VOLTAGE LED DRIVER 12-24V DC

Sono previste tre distinte modalità di funzionamento lette all'avvio (impostate tramite dip-switch prima dell'accensione):

3 different modality available before activation (set by DIP switch before switch-on).

• DALI - configurazione di fabbrica
Power ON: 100%
System fail level: 100%

• DALI - factory preset.
Power ON: 100%
System fail level: 100%

• PUSH - impostazioni tramite DIP
Funzionamento regolazione:
pressione breve del tasto per ON/OFF;
pressione lunga del tasto per dimmer.
Memorizzazione dell'ultimo dato di dimming.
In presenza rete ad ogni ON il driver parte dall'ultimo dato impostato.

• PUSH - setting by DIP
Regulation controls:
Short key push for on ON-OFF.
Long push for dimming:
Dimming memory sets on last dimming level.
When connected to main supply at each on-switching the driver will restart from last selected level.

Procedura di allineamento (necessaria per compensare gli errori di sincronizzazione quando si hanno tanti driver in parallelo): da posizione ON/OFF tenere premuto il tasto a lungo (30 sec.) i driver si porteranno al 100%; alla successiva pressione del tasto il flusso luminoso inizierà a diminuire in accordo al profilo impostato.

Alignment procedure (required to compensate errors in case many drivers are connected in parallel): from ON-OFF position hold the key pushed for a long time (30 sec.), all the drivers will go to 100%; at the next push light flux will decrease in conformity with selected setting.

Massima lunghezza totali cavi PUSH: 15 mt.

Maximum cable length for PUSH 15 m.

• DIMMING 1...10V - 0...10V - impostazioni tramite DIP

• DIMMING 1...10V or 0...10V - setting by DIP

Utilizzo di dimmer attivi o passivi (impostazione tramite ponticello):
Impostare il ponticello sulla posizione A per potenziometri attivi e sistemi domotici: impedenza 130K.

Use with active or passive dimmer (setting by jumper):
Position the jumper on A for active potentiometers or home-automation systems.

Impostare il ponticello sulla posizione B per potenziometri passivi: Iout max 1,4mA.

Impedance 130K.
Position the jumper on B for passive potentiometers: Iout max 1.4 mA.



0110/DIM DALI

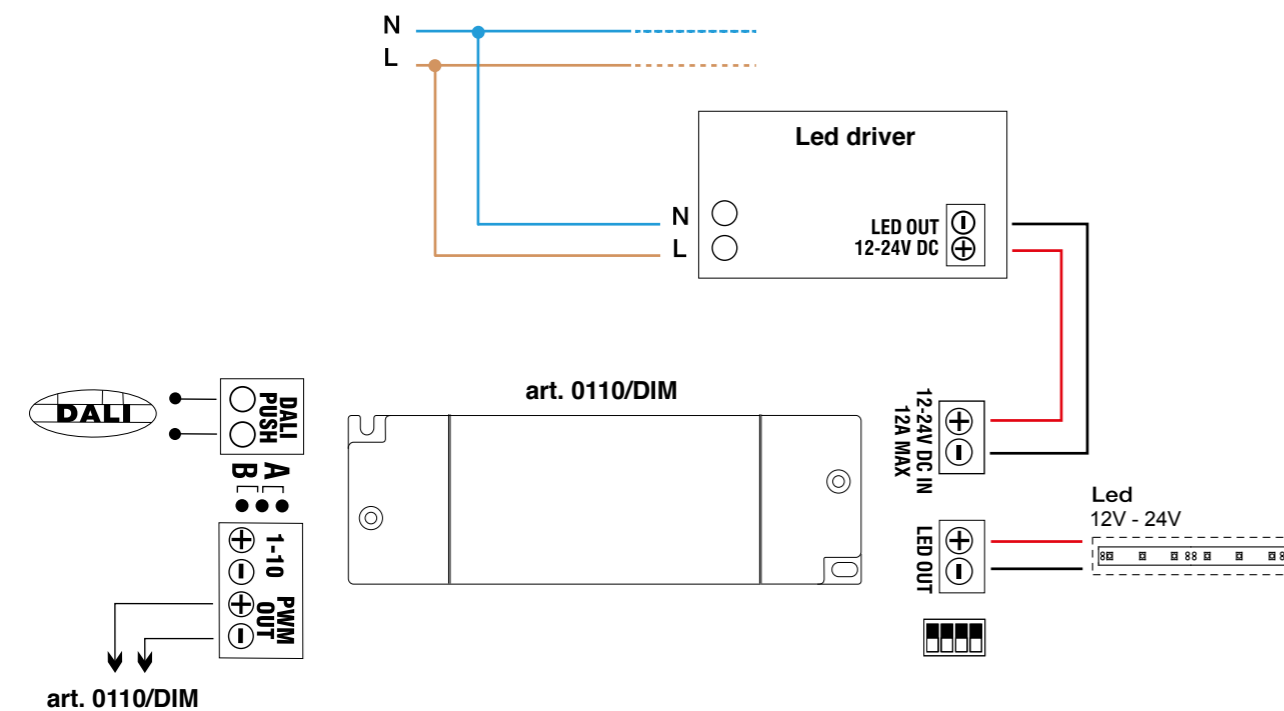

0110/DIM PUSH

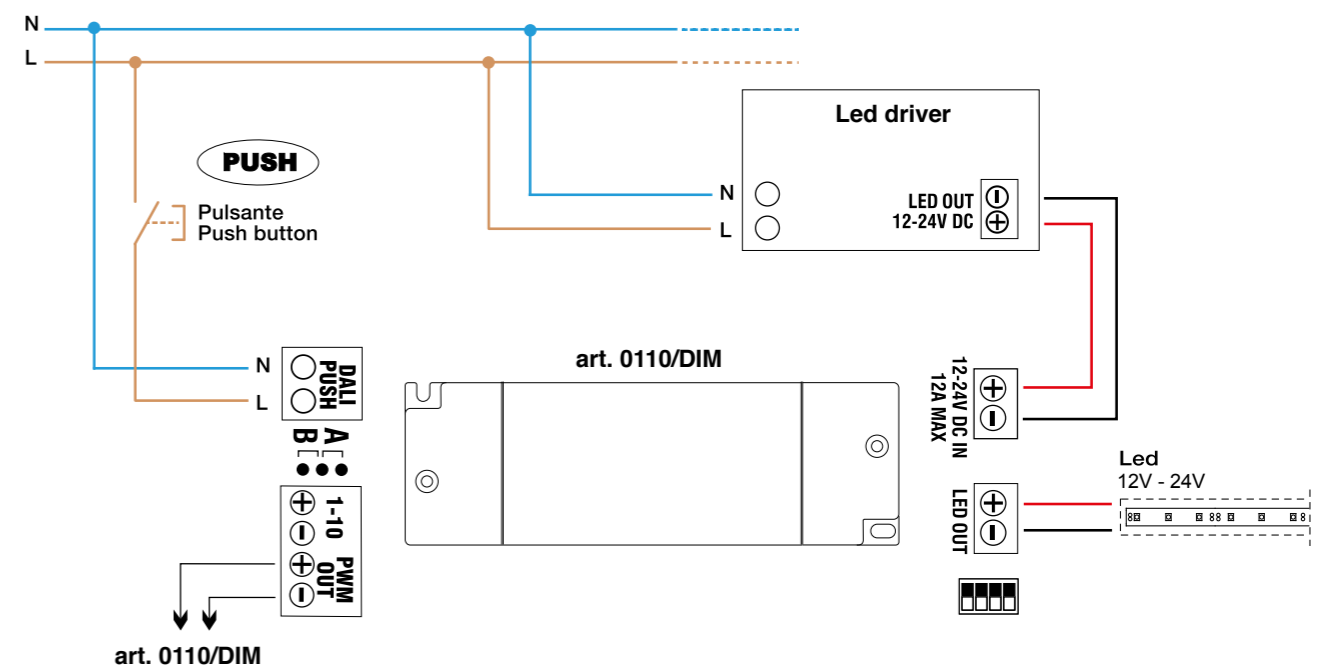

0110/DIM 1...10 V

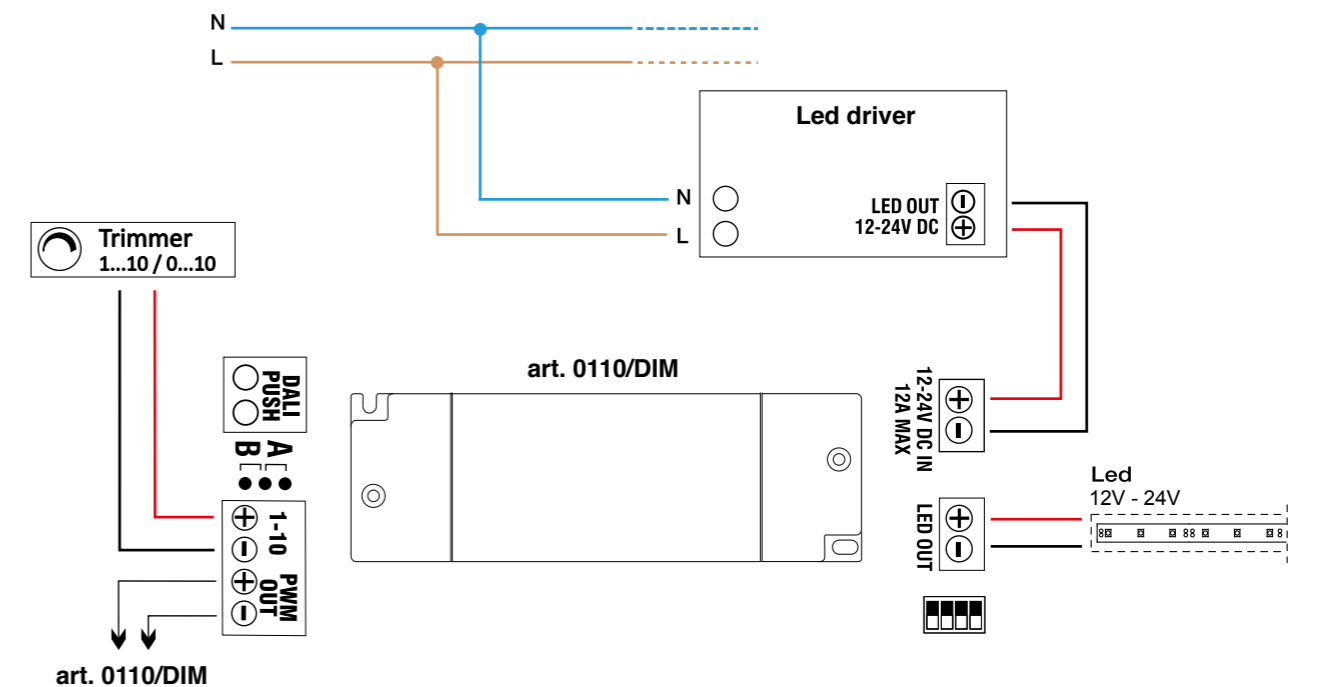

DIMMERAZIONE 24V PER LED STRIP

DIMMING 24V FOR LED STRIP

0717/DIM100

Technology

Technology



0717/DIM100

1) Ingresso DALI: selezionare il ponticello come indicato. Possibilità di collegare altri PBOX in parallelo attraverso il collegamento "Syncro".
 2) Ingresso 1...10V: selezionare il ponticello come indicato. Possibilità di collegare altri PBOX in parallelo attraverso il collegamento "Syncro".
 3) Ingresso Pulsante ON/OFF/Dimmer, selezionare il ponticello su "DALI" e attivare la memoria di stato. I collegamenti del pulsante sono in bassa tensione; mantenere isolamento dai collegamenti di rete
 Possibilità di collegare altri PBOX in parallelo attraverso il collegamento "Syncro".
 Togliere il ponticello a tutti i PBOX slave. Massimo 15 Slave.

1) *Input DALI: set the jumper as indicated. Possible parallel connection of more PBOX through Synchro-Mode*
 2) *Input 1...10V: set the jumper as indicated. Possible parallel connection of more PBOX through Synchro-Mode*
 3) *Input for push ON/OFF/Dimmer: set the jumper on Memory. Connections of push-button in low voltage; keep them far from mains connections. Possible parallel connection of more PBOX through Synchro-Mode. Remove the jumper by all Slaves. Max 15 pcs in total.*



1	2	3	4	Mode
OFF	OFF	ON	X	DALI
ON	OFF	ON	X	Push
OFF	ON	ON	X	0..10V
ON	ON	ON	X	1..10V
OFF	OFF	OFF	X	Slave

Impostazione del Dip-Switch ad apparecchio spento
 Dip-switch setting only when switched off

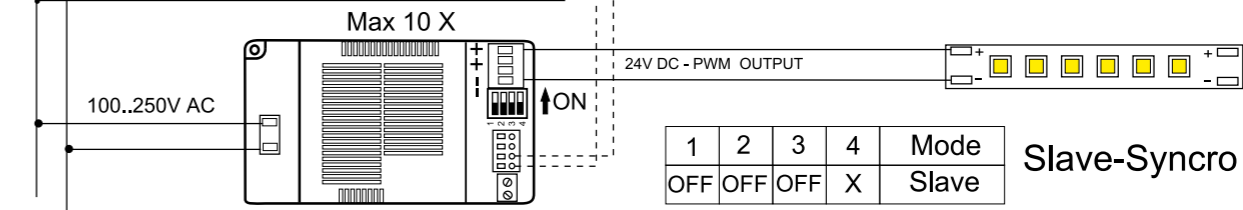
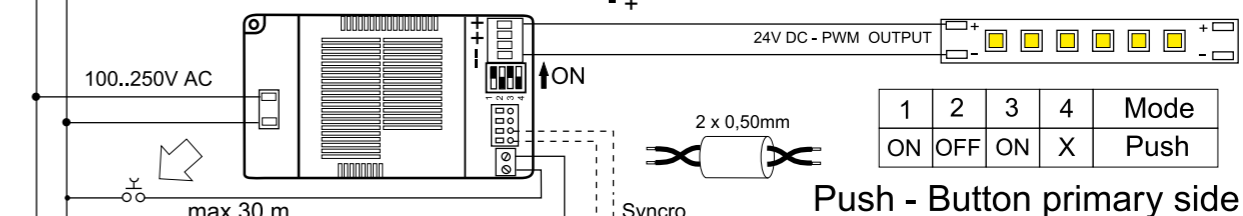
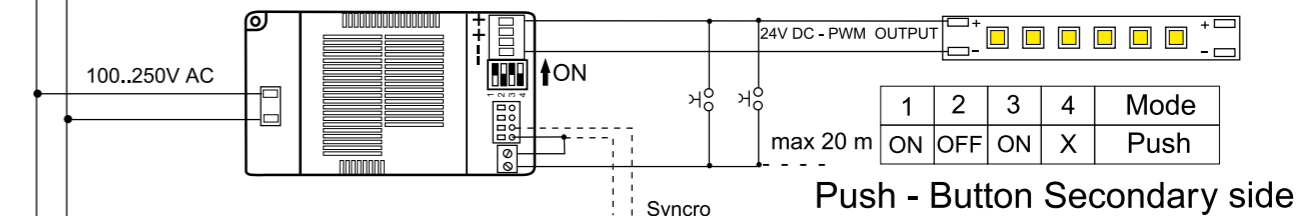
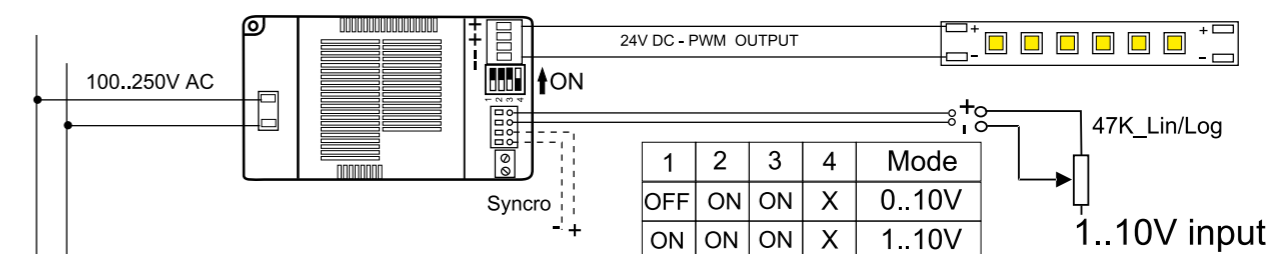
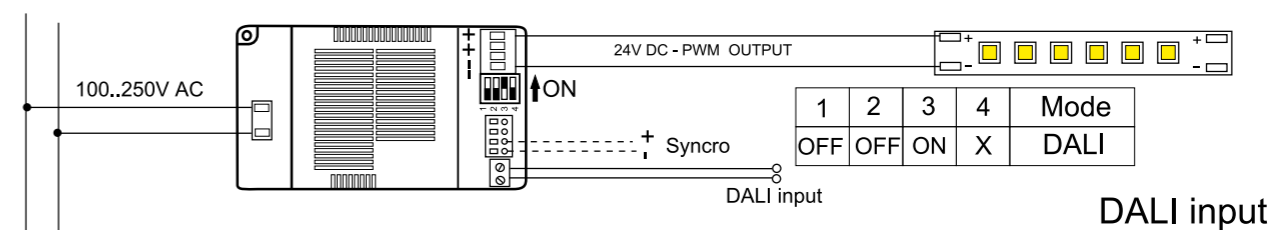

Linea Syncro: usare cavo per BUS dati , tenere lontano da cavi alta tensione per possibili disturbi
 Syncro Line: use data BUS cable , keep away from high voltage line to avoid interferences.

CONTROLLO RGB SMALL 22W

RGB CONTROL SMALL 22W

- 0167: alimentatore RGB master e slave uscita: 3 canali a 24V (max. 22W).
- 0168: converter RGB Ingresso 24V, uscita per moduli a 250mA (max. 5 Led per canale).
- 0166: cavo di sincronizzazione
- 0165: telecomando IR
- 0163: ricevitore IR

- 0167: RGB master and slave controller Output: 3 channels at 24V (max. 22W)
- 0168: RGB converter Input: 24V, modules output 250mA (max. 5 LED each channel)
- 0166: synchronization cable
- 0165: IR Remote controller
- 0163: IR Receiver



FUNZIONAMENTO REGOLAZIONE PUSH

- Pressione rapida da spento accensione con colore fisso ulteriori brevi pressioni attivano le scene luminose secondo la sequenza: RGB-WRGB-BG-YGR
- Pressione prolungata da spento (>2 sec.) attiva modalità scelta colore fisso; lentamente scorrono i colori, premendo brevemente si blocca scorrimento colori e una ulteriore pressione prolungata del tasto memorizza il colore e spegne il prodotto. Il colore scelto si ripresenterà come primo colore ad ogni accensione prodotto.

- Pressione prolungata spegne il prodotto.

HOW TO SELECT FUNCTIONS WITH PUSH BUTTON

- Short push with switched-off product Product will switch-on on a preselected fixed color, further short pushes will activate different lighting scenes following the sequence: RGB-WRGB-BG-YGR.

- Long push with switched-off product (>2 sec.) will activate choice of preselected fix color; colors changes slowly, a short push will stop on a selected color; a second long push will memorize this as preselected and then the product will switch off. Preselected color will be displayed as first any time you switch on the product.

- Long push with product switched on will switch off.

FUNZIONAMENTO TELECOMANDO

- Tasti regolazione singolo colore Premendo uno dei tasti colore si dimmerà il canale corrispondente. Se il canale (colore) non è alla massima intensità premendo il tasto si avrà un incremento di questa fino al massimo o fino al livello corrispondente al momento in cui si rilascia il tasto. Un ulteriore pressione del tasto inverte il verso di regolazione fino al totale spegnimento del canale o fino al livello corrispondente al momento in cui si rilascia il tasto. Se il canale (colore) è alla massima intensità premendo il tasto si avrà un decremento di questa fino allo spegnimento completo o fino al livello corrispondente al momento in cui si rilascia il tasto. Se si è nella funzione show, premere uno di questi tasti termina la funzione bloccando i colori nella condizione di quell'istante. Il tasto colore bianco regola l'intensità dei tre canali simultaneamente con la stessa modalità del singolo colore.

- Tasti tempo ciclo Sono disponibili i seguenti tasti: 30sec, 2min., 10min. Premere il tasto corrispondente al tempo ciclo desiderato.

- Tasto Show Permette la selezione di uno dei 4 show preimpostati: premendo il tasto si può scegliere lo show dal primo colore della sequenza Il tempo ciclo è di default 30 sec.

- Tasto accensione /spegnimento stand by Permette l'accensione e lo spegnimento del prodotto mettendolo in modalità stand by: alla prima accensione del prodotto i 3 canali saranno accesi alla massima intensità. Per le accensioni successive i canali saranno accesi all'intensità memorizzata allo spegnimento del prodotto.

REMOTE FUNCTIONS

- Single colour selection buttons Pushing one of those buttons dims corresponding channel (color). If the channel(color) is not at the max intensity, by pushing the button intensity will go up to maximum power or till the level reached when the button is released. A further push of the button will invert regulation mode and the intensity will fade up to total switch-off or till the level reached when the button is released. If the channel(color) is at the max intensity, the intensity will fade up to total switch-off or till the level reached when the button is released. If the show function is activated, pushing one of those buttons will terminate the show fixing the colors as they are. The white button dims all three channels simultaneously following same modality of color buttons.

- Cycle timing buttons Following buttons are available: 30sec, 2min., 10 min. Push the button corresponding at the desired cycle timing:

- Show button It allows selection among the 4 preset programs: first colour in a sequence can be selected by pushing this button. Default cycle duration is 30 sec.

- Switch on/off and stand-by button Controls on-off switching of the product activating standby mode: when switching on the product for the first time the 3 channels will activate at the intensity memorized during switch-off.

RGB push (22W)

220/240 Vac
50/60 Hz

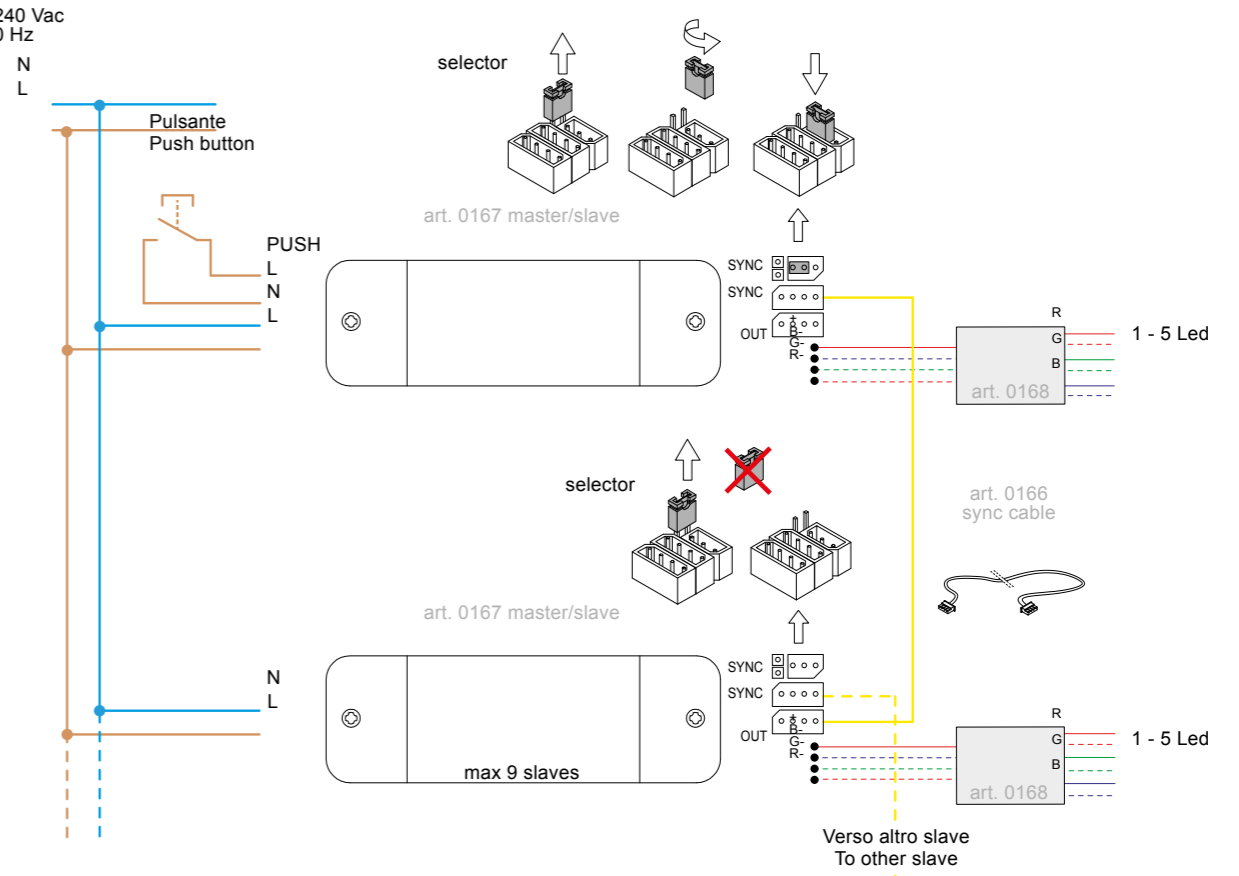

RGB remote (22W)

220/240 Vac
50/60 Hz

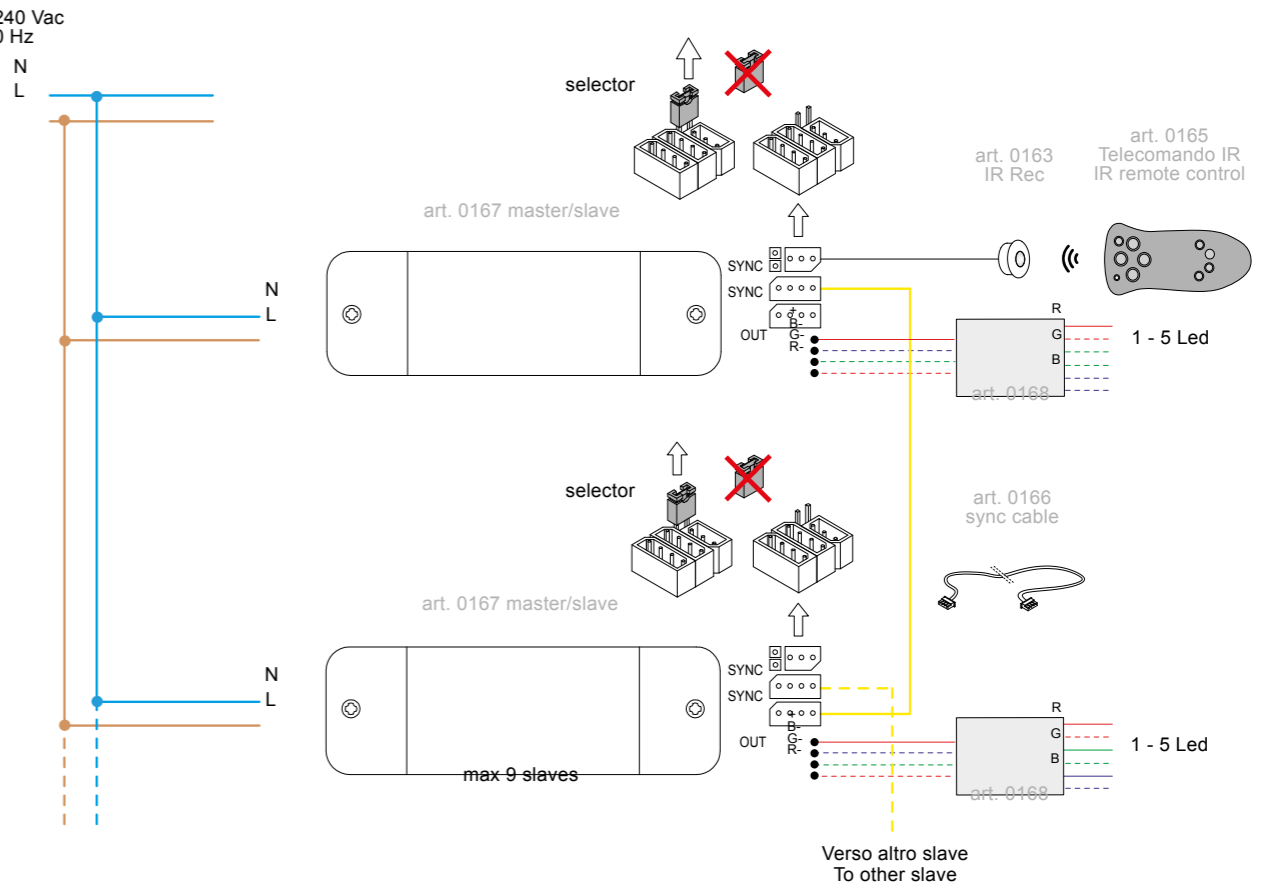

CONTROLLO RGB BIG 120W

RGB CONTROL BIG 120W

- 0164: alimentatore RGB master e slave uscita: 3 canali a 24V (max. 120W).
- 0168: converter RGB Ingresso 24V, uscita per moduli a 250mA (max. 5 Led per canale).
- 0166: cavo di sincronizzazione
- 0165: telecomando IR
- 0163: ricevitore IR

- 0164: RGB master and slave controller Output: 3 channels at 24V (max. 120W)
- 0168: RGB converter Input: 24V, modules output 250mA (max. 5 LED each channel)
- 0166: synchronization cable
- 0165: IR Remote control
- 0163: IR Receiver



FUNZIONAMENTO REGOLAZIONE PUSH

- Pressione rapida da spento accensione con colore fisso ulteriori brevi pressioni attivano le scene luminose secondo la sequenza: RGB-WRGB-BG-YGR
- Pressione prolungata da spento (>2 sec.) attiva modalità scelta colore fisso; lentamente scorrono i colori, premendo brevemente si blocca scorrimento colori e una ulteriore pressione prolungata del tasto memorizza il colore e spegne il prodotto. Il colore scelto si ripresenterà come primo colore ad ogni accensione prodotto.

- Pressione prolungata spegne il prodotto.

HOW TO SELECT FUNCTIONS WITH PUSH BUTTON

- Short push with switched-off product Product will switch-on on a preselected fixed color, further short pushes will activate different lighting scenes following the sequence: RGB-WRGB-BG-YGR.

- Long push with switched-off product (>2 sec.) will activate choice of preselected fix color; colors changes slowly, a short push will stop on a selected color; a second long push will memorize this as preselected and then the product will switch off. Preselected color will be displayed as first any time you switch on the product.

- Long push with product switched on will switch off.

FUNZIONAMENTO TELECOMANDO

- Tasti regolazione singolo colore Premendo uno dei tasti colore si dimmerà il canale corrispondente. Se il canale (colore) non è alla massima intensità premendo il tasto si avrà un incremento di questa fino al massimo o fino al livello corrispondente al momento in cui si rilascia il tasto. Un ulteriore pressione del tasto inverte il verso di regolazione fino al totale spegnimento del canale o fino al livello corrispondente al momento in cui si rilascia il tasto. Se il canale (colore) è alla massima intensità premendo il tasto si avrà un decremento di questa fino allo spegnimento completo o fino al livello corrispondente al momento in cui si rilascia il tasto. Se si è nella funzione show, premere uno di questi tasti termina la funzione bloccando i colori nella condizione di quell'istante. Il tasto colore bianco regola l'intensità dei tre canali simultaneamente con la stessa modalità del singolo colore.

- Tasti tempo ciclo Sono disponibili i seguenti tasti: 30sec, 2min., 10min. Premere il tasto corrispondente al tempo ciclo desiderato.

- Tasto Show Permette la selezione di uno dei 4 show preimpostati: premendo il tasto si può scegliere lo show dal primo colore della sequenza Il tempo ciclo è di default 30 sec.

- Tasto accensione /spegnimento stand by Permette l'accensione e lo spegnimento del prodotto mettendolo in modalità stand by: alla prima accensione del prodotto i 3 canali saranno accesi alla massima intensità. Per le accensioni successive i canali saranno accesi all'intensità memorizzata allo spegnimento del prodotto.

REMOTE FUNCTIONS

- Single colour selection buttons Pushing one of those buttons dims corresponding channel (color). If the channel(color) is not at the max intensity, by pushing the button intensity will go up to maximum power or till the level reached when the button is released. A further push of the button will invert regulation mode and the intensity will fade up to total switch-off or till the level reached when the button is released. If the channel(color) is at the max intensity, the intensity will fade up to total switch-off or till the level reached when the button is released. If the show function is activated, pushing one of those buttons will terminate the show fixing the colors as they are. The white button dims all three channels simultaneously following same modality of color buttons.

- Cycle timing buttons Following buttons are available: 30sec, 2min., 10 min. Push the button corresponding at the desired cycle timing:

- Show button It allows selection among the 4 preset programs: first colour in a sequence can be selected by pushing this button. Default cycle duration is 30 sec.

- Switch on/off and stand-by button Controls on-off switching of the product activating standby mode: when switching on the product for the first time the 3 channels will activate at max power. After that each channel will switch-on at the intensity memorized during switch-off.

RGB push (120W)

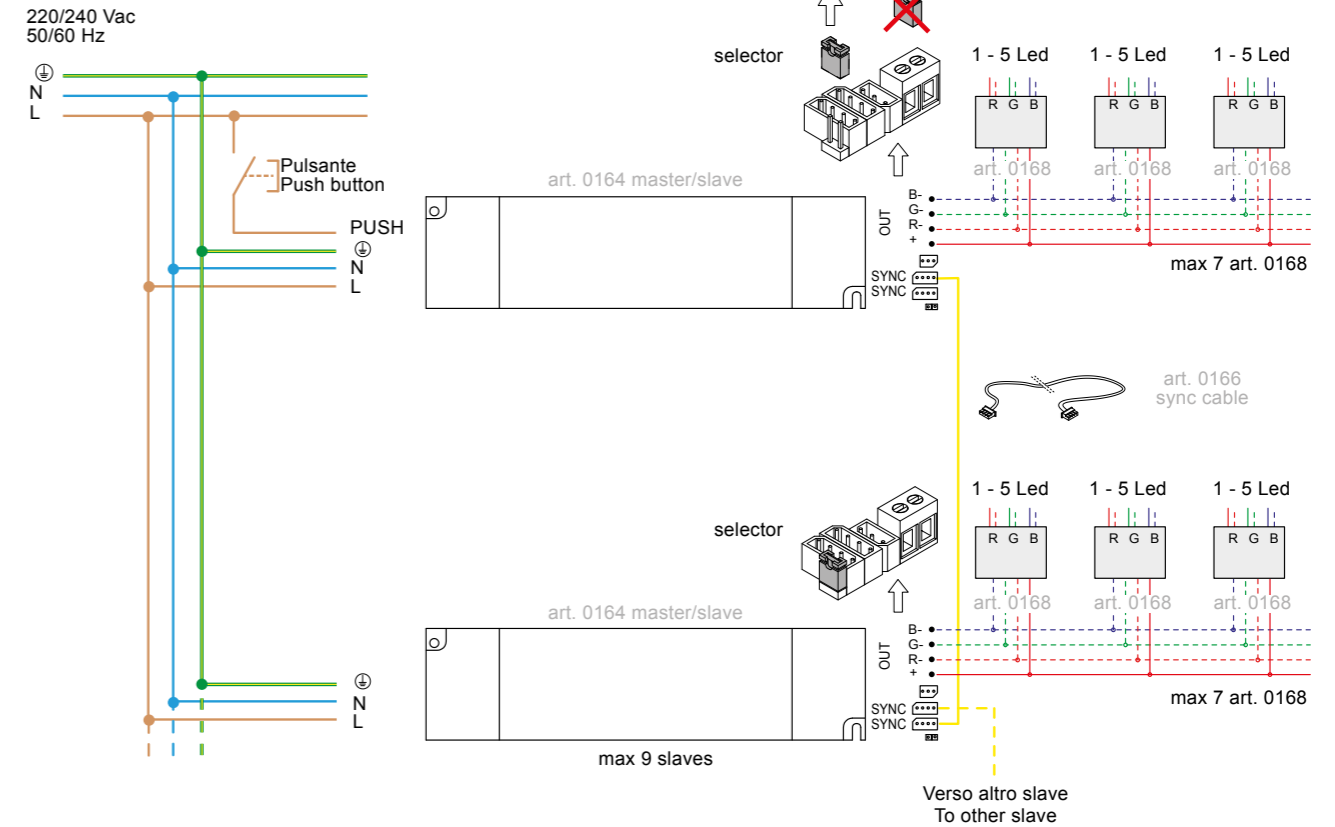

RGB remote (120W)

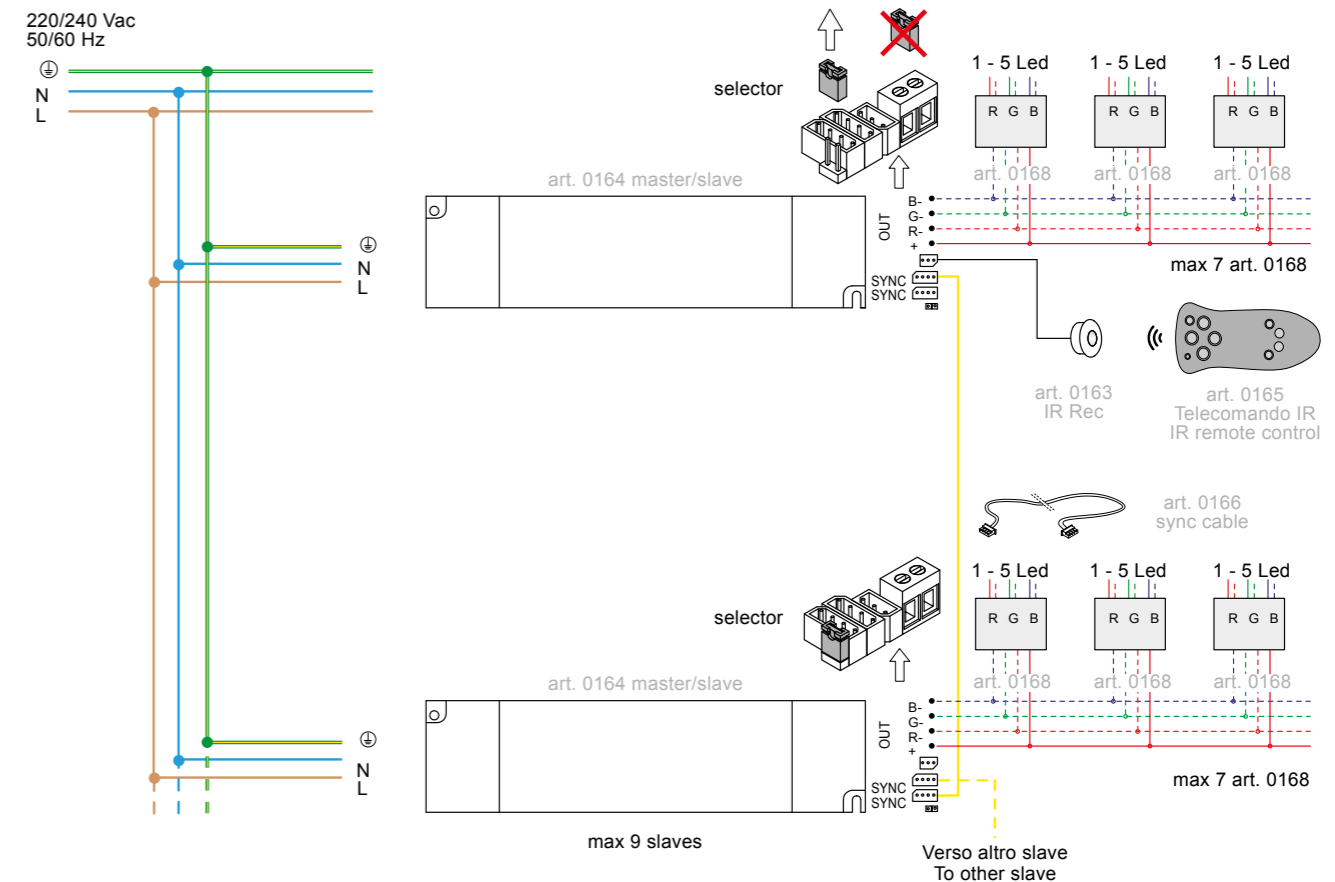

CONTROLLO RGB PER LED STRIP SMALL 22W

RGB CONTROL SMALL 22W FOR LED STRIP

- 0167: alimentatore RGB master e slave uscita: 3 canali a 24V (max. 22W).
- 0166: cavo di sincronizzazione
- 0165: telecomando IR
- 0163: ricevitore IR

- 0167: RGB master and slave controller Output: 3 channels at 24V (max. 22W)
- 0166: synchronization cable
- 0165: IR Remote control
- 0163: IR Receiver



FUNZIONAMENTO REGOLAZIONE PUSH

- Pressione rapida da spento accensione con colore fisso ulteriori brevi pressioni attivano le scene luminose secondo la sequenza: RGB-WRGB-BG-YGR
- Pressione prolungata da spento (>2 sec.) attiva modalità scelta colore fisso; lentamente scorrono i colori, premendo brevemente si blocca scorrimento colori e una ulteriore pressione prolungata del tasto memorizza il colore e spegne il prodotto. Il colore scelto si ripresenterà come primo colore ad ogni accensione prodotto.
- Pressione prolungata spegne il prodotto.

HOW TO SELECT FUNCTIONS WITH PUSH BUTTON

- **Short push with switched-off product**
Product will switch-on on a preselected fixed color, further short pushes will activate different lighting scenes following the sequence: RGB-WRGB-BG-YGR.
- **Long push with switched-off product (>2 sec.)**
will activate choice of preselected fix color; colors changes slowly, a short push will stop on a selected color; a second long push will memorize this as preselected and then the product will switch off.
Preselected color will be displayed as first any time you switch on the product.
- **Long push with product switched on**
will switch off.

FUNZIONAMENTO TELECOMANDO

- Tasti regolazione singolo colore
Premendo uno dei tasti colore si dimmerà il canale corrispondente.
Se il canale (colore) non è alla massima intensità premendo il tasto si avrà un incremento di questa fino al massimo o fino al livello corrispondente al momento in cui si rilascia il tasto. Un'ulteriore pressione del tasto inverte il verso di regolazione fino al totale spegnimento del canale o fino al livello corrispondente al momento in cui si rilascia il tasto.
Se il canale (colore) è alla massima intensità premendo il tasto si avrà un decremento di questa fino allo spegnimento completo o fino al livello corrispondente al momento in cui si rilascia il tasto. Se si è nella funzione show, premere uno di questi tasti termina la funzione bloccando i colori nella condizione di quell'istante.
Il tasto colore bianco regola l'intensità dei tre canali simultaneamente con la stessa modalità del singolo colore.
- Tasti tempo ciclo
Sono disponibili i seguenti tasti: 30sec, 2min., 10min. Premere il tasto corrispondente al tempo ciclo desiderato.
- Tasto Show
Permette la selezione di uno dei 4 show preimpostati: premendo il tasto si può scegliere lo show dal primo colore della sequenza. Il tempo ciclo è di default 30 sec.
- Tasto accensione /spegnimento stand by
Permette l'accensione e lo spegnimento del prodotto mettendolo in modalità stand by: alla prima accensione del prodotto i 3 canali saranno accesi alla massima intensità. Per le accensioni successive i canali saranno accesi all'intensità memorizzata allo spegnimento del prodotto.

REMOTE FUNCTIONS

- **Single colour selection buttons**
Pushing one of those buttons dims corresponding channel (color).
If the channel(color) is not at the max intensity, by pushing the button intensity will go up to maximum power or till the level reached when the button is released.
A further push of the button will invert regulation mode and the intensity will fade up to total switch-off or till the level reached when the button is released.
If the channel(color) is at the max intensity, the intensity will fade up to total switch-off or till the level reached when the button is released.
If the show function is activated, pushing one of those buttons will terminate the show fixing the colors as they are.
The white button dims all three channels simultaneously following same modality of color buttons.
- **Cycle timing buttons**
Following buttons are available: 30sec, 2min., 10 min. Push the button corresponding at the desired cycle timing:
- **Show button**
It allows selection among the 4 preset programs: first colour in a sequence can be selected by pushing this button. Default cycle duration is 30 sec.
- **Switch on/off and stand-by button**
Controls on-off switching of the product activating standby mode: when switching on the product for the first time the 3 channels will activate at max power. After that each channel will switch-on at the intensity memorized during switch-off.

RGB push (22W)

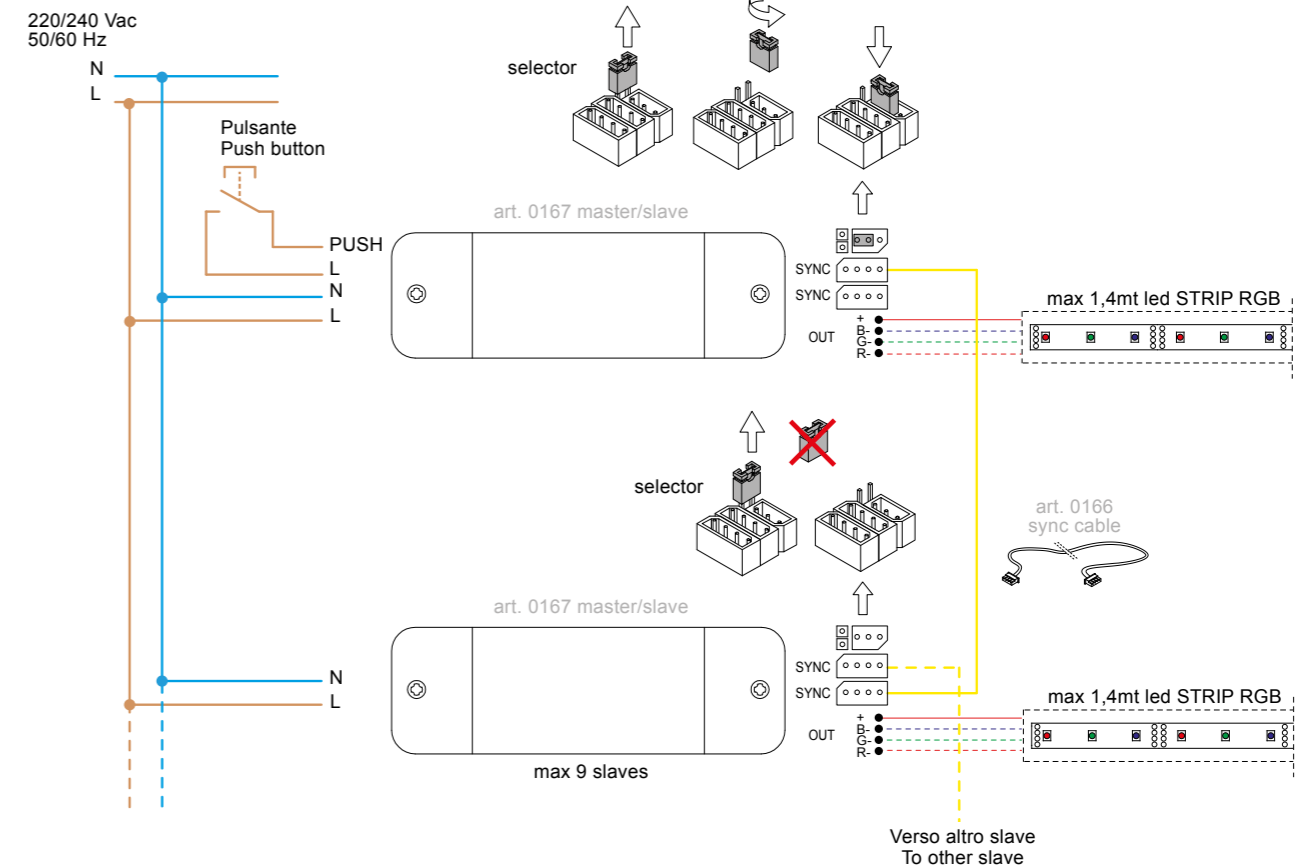

RGB remote (22W)

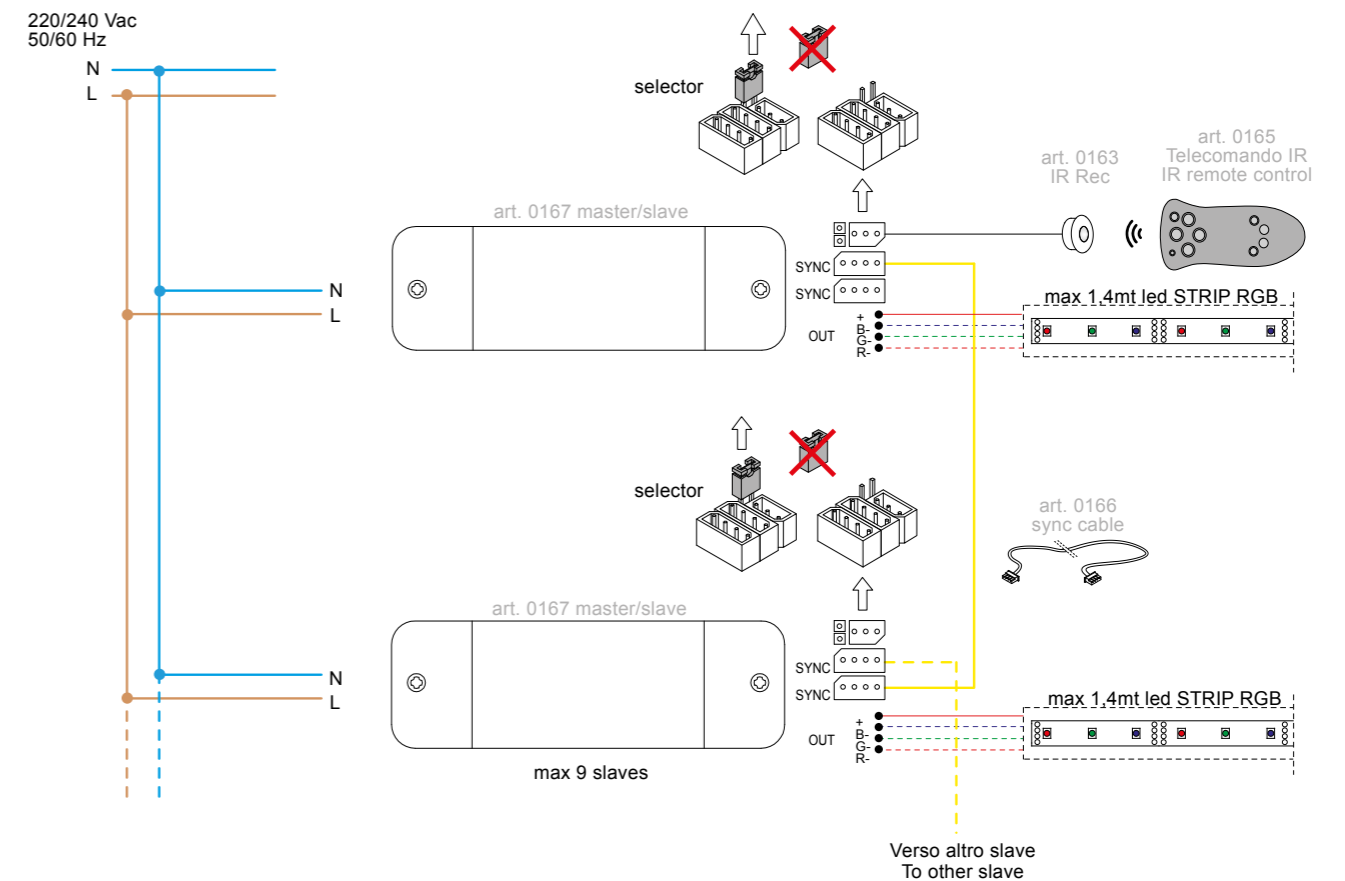

CONTROLLO RGB BIG 120W PER LED STRIP

RGB CONTROL BIG 120W FOR LED STRIP

0164: alimentatore RGB master e slave
uscita: 3 canali a 24V (max. 120W).

0166: cavo di sincronizzazione

0165: telecomando IR

0163: ricevitore IR

0164: RGB master and slave controller
Output: 3 channels at 24V (max. 120W)

0166: synchronization cable

0165: IR Remote control

0163: IR Receiver



FUNZIONAMENTO REGOLAZIONE PUSH

- Pressione rapida da spento accensione con colore fisso ulteriori brevi pressioni attivano le scene luminose secondo la sequenza: RGB-WRGB-BG-YGR

- Pressione prolungata da spento (>2 sec.) attiva modalità scelta colore fisso; lentamente scorrono i colori, premendo brevemente si blocca scorrimento colori e una ulteriore pressione prolungata del tasto memorizza il colore e spegne il prodotto. Il colore scelto si ripresenterà come primo colore ad ogni accensione prodotto.

- Pressione prolungata spegne il prodotto.

HOW TO SELECT FUNCTIONS WITH PUSH BUTTON

- **Short push with switched-off product**
Product will switch-on on a preselected fixed color, further short pushes will activate different lighting scenes following the sequence: RGB-WRGB-BG-YGR.

- **Long push with switched-off product (>2 sec.)**
will activate choice of preselected fix color; colors changes slowly, a short push will stop on a selected color; a second long push will memorize this as preselected and then the product will switch off. Preselected color will be displayed as first any time you switch on the product.

- **Long push with product switched on**
will switch off.

FUNZIONAMENTO TELECOMANDO

- Tasti regolazione singolo colore
Premendo uno dei tasti colore si dimmerà il canale corrispondente.

Se il canale (colore) non è alla massima intensità premendo il tasto si avrà un incremento di questa fino al massimo o fino al livello corrispondente al momento in cui si rilascia il tasto. Un'ulteriore pressione del tasto inverte il verso di regolazione fino al totale spegnimento del canale o fino al livello corrispondente al momento in cui si rilascia il tasto.

Se il canale (colore) è alla massima intensità premendo il tasto si avrà un decremento di questa fino allo spegnimento completo o fino al livello corrispondente al momento in cui si rilascia il tasto. Se si è nella funzione show, premere uno di questi tasti termina la funzione bloccando i colori nella condizione di quell'istante.

Il tasto colore bianco regola l'intensità dei tre canali simultaneamente con la stessa modalità del singolo colore.

- Tasti tempo ciclo
Sono disponibili i seguenti tasti: 30sec, 2min., 10min. Premere il tasto corrispondente al tempo ciclo desiderato.

- Tasto Show
Permette la selezione di uno dei 4 show preimpostati: premendo il tasto si può scegliere lo show dal primo colore della sequenza. Il tempo ciclo è di default 30 sec.

- Tasto accensione /spegnimento stand by
Permette l'accensione e lo spegnimento del prodotto mettendolo in modalità stand by: alla prima accensione del prodotto i 3 canali saranno accesi alla massima intensità. Per le accensioni successive i canali saranno accesi all'intensità memorizzata allo spegnimento del prodotto.

REMOTE FUNCTIONS

- **Single colour selection buttons**
Pushing one of those buttons dims corresponding channel (color).

If the channel(color) is not at the max intensity, by pushing the button intensity will go up to maximum power or till the level reached when the button is released. A further push of the button will invert regulation mode and the intensity will fade up to total switch-off or till the level reached when the button is released.

If the channel(color) is at the max intensity, the intensity will fade up to total switch-off or till the level reached when the button is released. If the show function is activated, pushing one of those buttons will terminate the show fixing the colors as they are. The white button dims all three channels simultaneously following same modality of color buttons.

- **Cycle timing buttons**
Following buttons are available: 30sec, 2min., 10 min. Push the button corresponding at the desired cycle timing:

- **Show button**
It allows selection among the 4 preset programs: first colour in a sequence can be selected by pushing this button. Default cycle duration is 30 sec.

- **Switch on/off and stand-by button**
Controls on-off switching of the product activating standby mode: when switching on the product for the first time the 3 channels will activate at max power. After that each channel will switch-on at the intensity memorized during switch-off.

RGB push (120W)

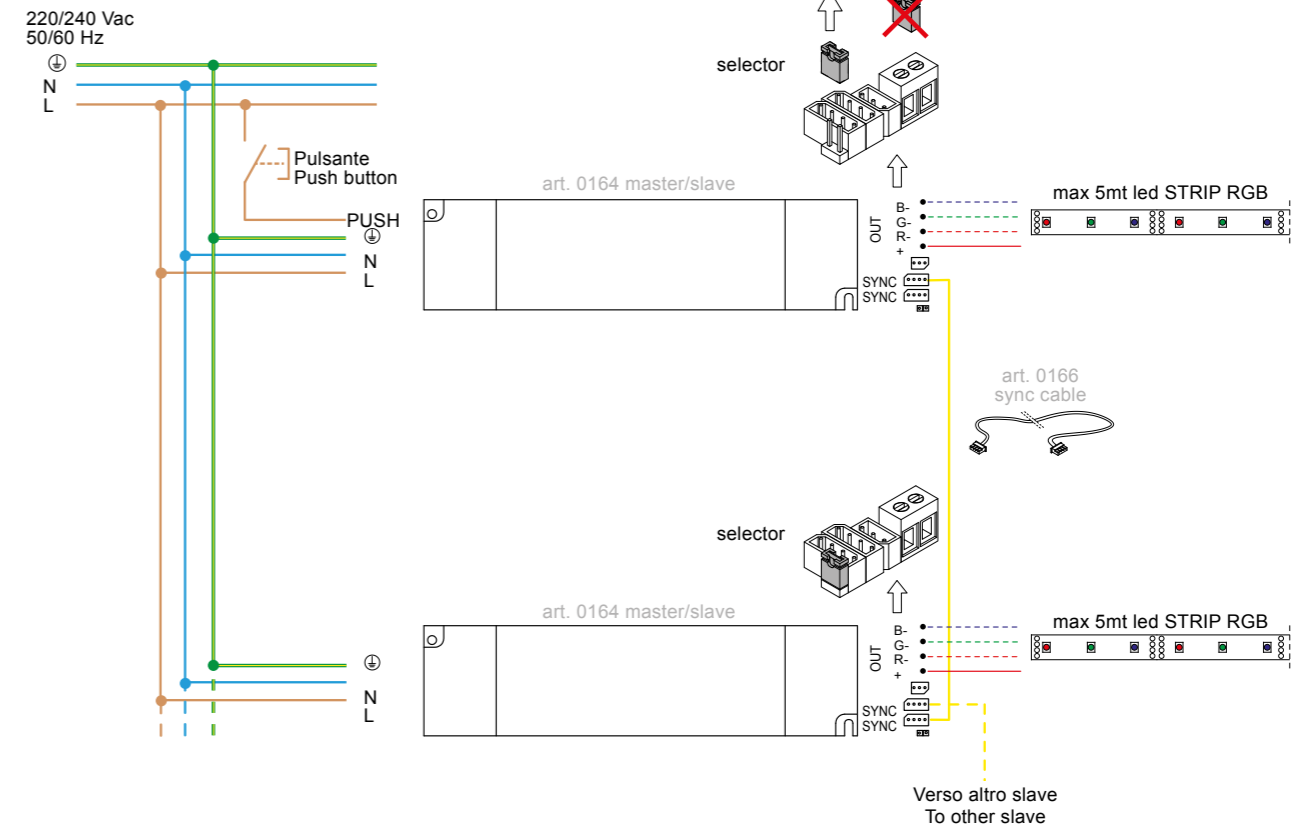

RGB remote (120W)

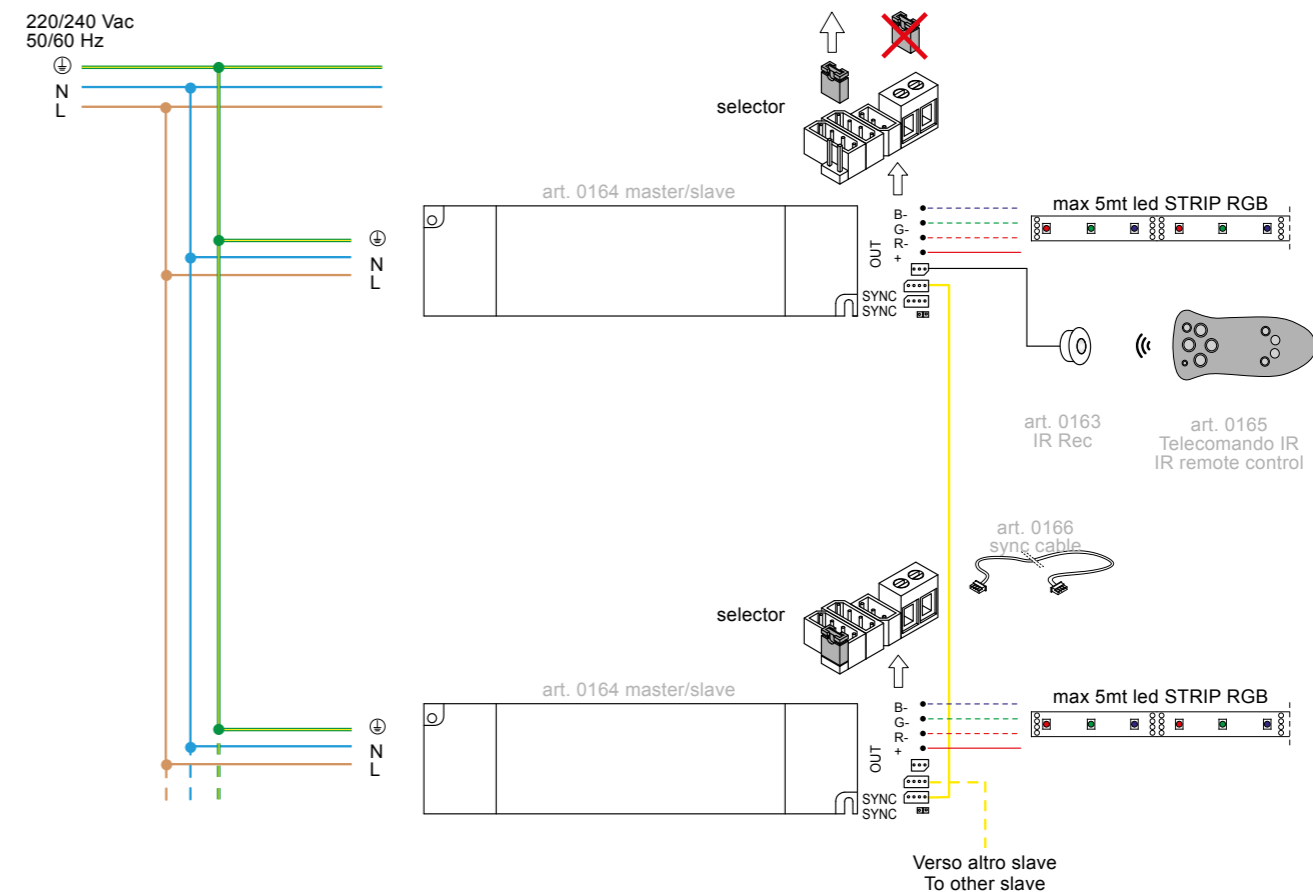

INTERFACCIA DMX - RGB

DMX - RGB INTERFACE

Technology



0729/DMX

Caratteristiche

- Interfaccia in grado di convertire il segnale con protocollo DMX in tre segnali PWM separati.
- Selezione indirizzo DMX tramite tre selettori rotativi posti sulla parte superiore dell'interfaccia.
- E' possibile inoltre utilizzare un unico cavo di sincronizzazione multicanale RGB (art.0166 fornito separatamente) per connettere fino a 10 alimentatori art. 0164, 0167.
- Il convertitore può essere alimentato direttamente dalla rete (100 ÷ 240 VAC).
- DMX mode tramite morsetteria per collegamento basato su protocollo DMX512A standard. Selettori rotativi tipo BCD per impostazione indirizzi e inserimento resistenza di terminazione linea.
- LED per indicazione dello stato della trasmissione DMX e velocità show.

Features

- Interface which can convert a signal with DMX protocol into three separated PWM signal.
- DMX address selection through 3 selectors on the upper side of the interface.
- It is possible to use one RGB multichannel sync cable (art.0166 supplied separated) to connect up to 10 drivers of 0164,0167
- The converter can be powered directly from the mains (100 ÷ 240 VAC). DMX mode based on DMX 512A Standard. BCD rotary switch for setting DMX address and line termination resistor.
- LED indicator of the state of DMX transmission and show speed.

0729/DMX + Art. 0167

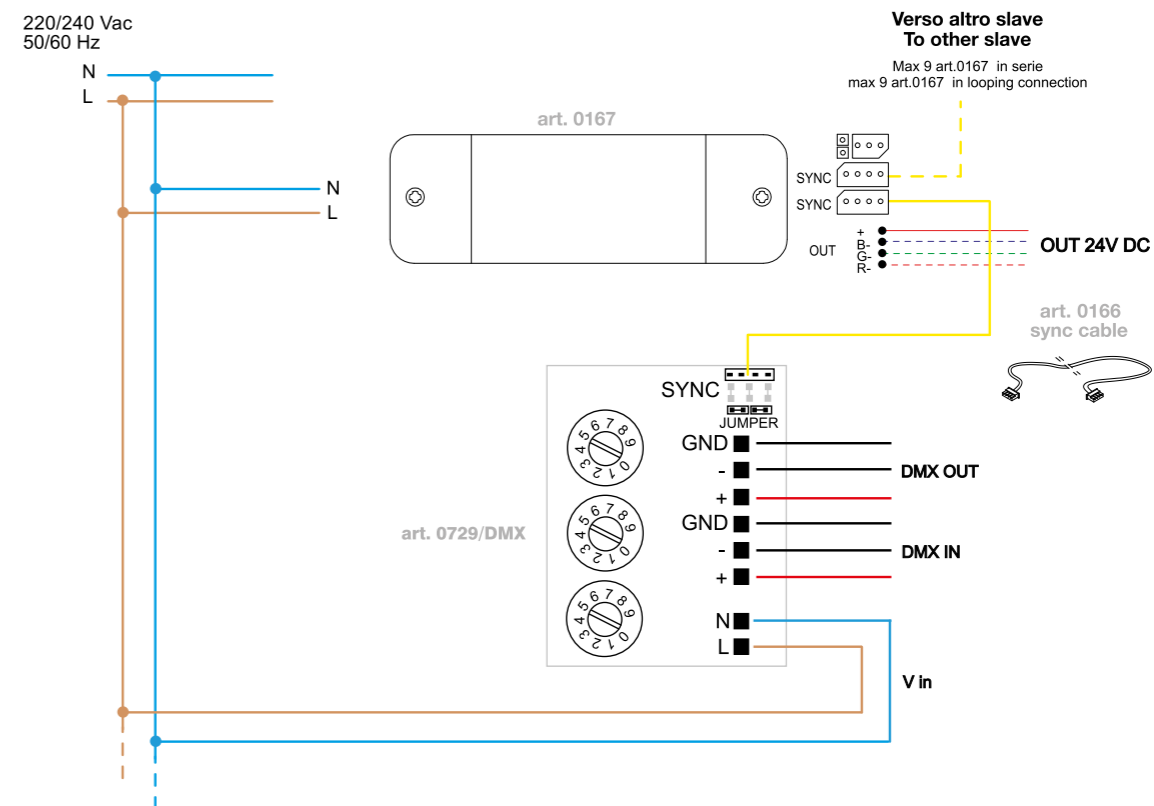

0729/DMX + Art. 0164

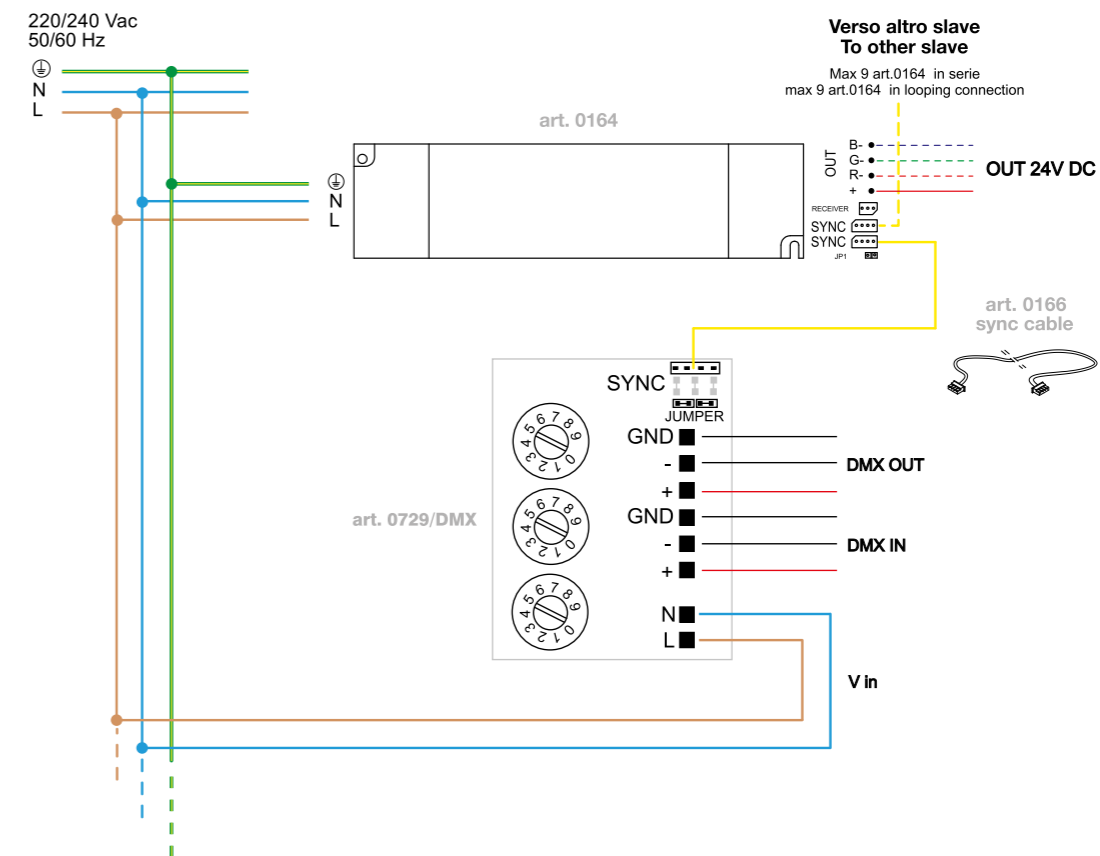

Technology

CONTROLLO EMERGENZA LED

LED EMERGENCY CONTROL



0115/EM (1h.) - 0115/EM/3 (3h.)

Gli alimentatori elettronici per illuminazione d'emergenza a funzionamento intermittente sono predisposti per alimentare LED di potenza (controllati in corrente) o moduli led (controllati in tensione) con la normale tensione di rete (220-240V - 50/60Hz), possono essere collegati per funzionamento permanente o non permanente, con qualsiasi tipo di alimentatore elettronico per LED. Tutti i modelli sono dotati di accumulatori ermetici al Ni-Cd in grado di garantire elevati rendimenti anche con alte temperature.

Caratteristiche tecniche:

- tensione di alimentazione: 220+240V - 50/60Hz
- tempo di funzionamento in emergenza: 1h o 3h
- tempo di ricarica: 24h
- collegabili ad alimentatori con tensione massima in uscita 90V, corrente massima in uscita 2A

Collegamenti:

- per non danneggiare i led collegare nell'ordine:
- sorgente LED
 - cavo batteria
 - alimentazione di rete
- non scollegare e ricollegare i LED con emergenza in funzione.

The electronic units for emergency lighting are suitable for power LED (current controlled) or LED modules (voltage controlled). They can be used indifferently for maintained (main, 220/240V - 50/60Hz, in combination with LED electronic driver), or emergency operation. All the models have sealed Ni-Cd batteries able to guarantee high efficiency with high temperatures.

Technical characteristics:

- supply voltage: 220+240V - 50/60Hz
- emergency light working time: 1h or 3h
- recharging time: 24h
- connected to power supplies 90V maximum output voltage 2A maximum output current

Wiring:

to not cause LED damage, please connect following this order:

- LED source
- battery cable
- mains connection

do not disconnect and connect the LED source during emergency operation.

0115/EM (1h.) - 0115/EM/3 (3h.)

Non permanente (solo emergenza) - Non-maintained (emergency only)

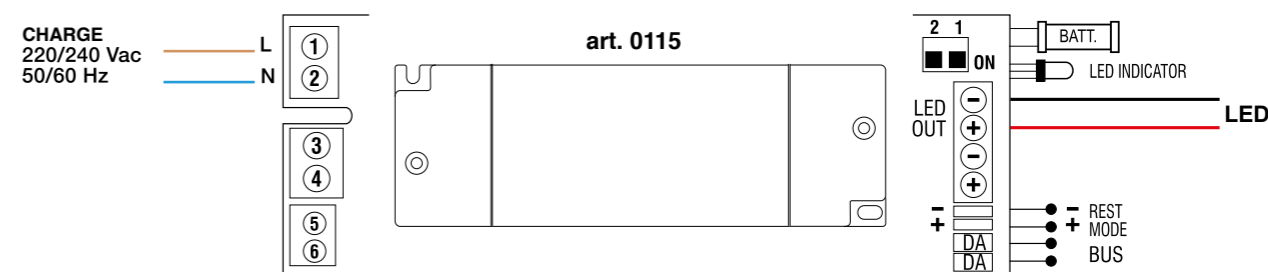

0115/EM (1h.) - 0115/EM/3 (3h.)

Permanente con alimentatore elettronico esterno (illuminazione ordinaria) - Maintained with external electronic driver

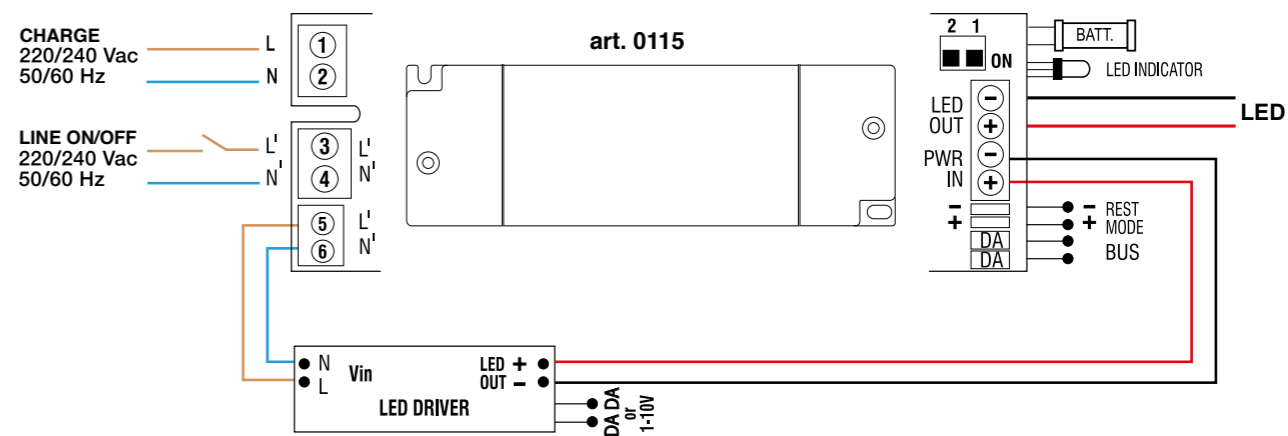

Tecnologia di comunicazione wireless per il controllo diretto da smartwatch, smartphone e tablet. Ideale per applicazioni residenziali e spazi commerciali.

CASAMBI è la giusta risposta ai clienti che cercano una soluzione che permetta la gestione semplice e User-friendly delle lampade, specialmente in ambito residenziale e commerciale.

CASAMBI consente di modificare l'intensità o il colore della luce in diversi modi. Questo sistema può essere usato per conseguire risparmi energetici, attivare scenari dinamici e fornire un'illuminazione incentrata sulle persone che ne promuove il benessere.

Grazie alla funzione timer è possibile richiamare scene luminose in determinati orari. Oltretutto, i moduli **CASAMBI** sono provvisti della tecnologia beacon per cui la luce può essere impiegata come guida per individuare il percorso migliore per raggiungere una determinata meta o come funzione «seguiami». (la luce si accende solo quando l'utente è vicino alla lampada).

L'App **CASAMBI** è facile da usare, si scarica gratuitamente. Segui questi semplici passaggi.

1. Scarica l'App dall'Apple App Store o da Google Play Store.
2. Accendi i tuoi apparecchi **CASAMBI**.
3. Apri l'App.
4. L'app **CASAMBI** troverà automaticamente tutti gli apparecchi abilitati **CASAMBI** che sono accesi.
5. Tocca "Utilizza tutti gli apparecchi di illuminazione"
6. L'App **CASAMBI** aggiungerà automaticamente tutti gli apparecchi a una rete e apre la scheda "Apparecchi"

Se vuoi controllare i tuoi apparecchi da più di un dispositivo mobile devi farlo modificare le impostazioni di condivisione della rete.

Come impostazione predefinita, la rete creata non lo è condiviso e archiviato solo nel dispositivo che lo ha creato.

1. Vai alla scheda "Altro" e seleziona "Configurazione della rete" e "Impostazioni di condivisione".
2. Toccare la condivisione e si aprirà la schermata "Modalità di condivisione".
3. Esistono quattro diverse modalità di condivisione: non condivisa, solo amministratore, Protetto da password e Apri. Quando selezioni Solo amministratore, Protetto da password o modalità aperta la rete verrà caricata sul server cloud e quindi è possibile accedervi anche da altri dispositivi mobili.
4. Aggiungi un indirizzo e-mail e una password per la rete. L'indirizzo e-mail è necessario per l'accesso remoto e il recupero della password.
5. Confermare le impostazioni con "Salva".

Dispositivi supportati **CASAMBI** App per iOS:
Richiede iOS 9.0 o successivo. iPhone 4S, iPhone 5, iPhone 5S, iPhone 5C o modelli più recenti, iPad di terza generazione (2012, A14xx) o più recenti, iPad mini tutti i modelli, iPod touch di sesta generazione o più recente.

Dispositivi supportati App **CASAMBI** per Android:
Requisiti minimi: dispositivi con Android 4.4 KitKat e BLE (Bluetooth Low Energy, BT 4.0)
Requisiti consigliati: dispositivi con Android 5.0 Lollipop o successivo e BLE (Bluetooth Low Energy, BT 4.0)

Wireless communication technology for direct control from smartwatches, smartphones and tablets. Ideal for residential applications and commercial spaces.

CASAMBI is the right answer for customers looking for a mesh solution that allows management simple and user-friendly of the lamps, especially in residential and commercial environments.

CASAMBI allows you to change the intensity or color of light in different ways. This system can be used to achieve energy savings, activate dynamic scenarios and provide lighting focused on the people who promote their well-being.

Thanks to the timer function it is possible to recall light scenes at certain times. Moreover, i **CASAMBI** modules are equipped with beacon technology whereby light can be used as guide to identify the best route to reach a certain destination or function "Follow me" (the light comes on only when the user is near the lamp).

It's very simple: download the **CASAMBI** app for free and follow these simple steps.

1. Download the app from Apple App Store or Google Play Store.
2. Turn on your **CASAMBI** enabled luminaires.
3. Open the app.
4. **CASAMBI** app will automatically find all **CASAMBI** enabled luminaires that are switched on.
5. Tap on the 'Take all luminaires into use'
6. **CASAMBI** app will automatically add all luminaires to one network and open the 'Luminaires' tab

If you want to control your luminaires from more than one mobile device you need to change the network sharing settings.

As a default the created network is not shared and only stored in the device that created it.

1. Go to 'More' tab and select 'Network setup' and 'Sharing settings'.
2. Tap on the Sharing and the 'Sharing mode' screen will open.
3. There are four different sharing modes: Not Shared, Administrator only, Password protected and Open. When you select Administrator only, Password protected or Open mode the network will be uploaded to cloud server and then it can be accessed also from other mobile devices.
4. Add an email address and a password for the network. Email address is needed for remote access and password recovery.
5. Confirm your settings with 'Save'.

Supported devices **CASAMBI** App for iOS:
Requires iOS 9.0 or later. iPhone 4S, iPhone 5, iPhone 5S, iPhone 5C or newer models, 3rd generation iPad (2012, A14xx) or newer, iPad mini all models, 6th generation iPod touch or newer.

Supported devices **CASAMBI** App for Android:
Minimum Requirements: Devices with Android 4.4 KitKat and BLE (Bluetooth Low Energy, BT 4.0)
Recommended Requirements: Devices with Android 5.0 Lollipop or Later and BLE (Bluetooth Low Energy, BT 4.0)



Alimentatore elettronico regolabile con uscita in tensione per moduli LED, tre uscite per moduli LED (RGB) con integrato modulo wireless CASAMBI.

Dimmable electronic driver with output voltage for LED modules, three outputs for LED modules (RGB) with integrated wireless CASAMBI module.



To be used through APP available on Apple Store and Play Store for iOS and Android. Utilizzabile tramite APP disponibile su Apple Store e Play Store per sistemi iOS e Android.

CASAMBI PROFILE	Channels
Independent channel mode Modalità canali indipendenti	CH 0 - 1 - 2
Tunable White mode Modalità Tunable White	CH 0 (W) - 1 (C)
RGB mode Modalità RGB	CH 0 - 1 - 2

0164/CASA - RGB (120W) FOR LED STRIP

220/240 Vac
50/60 Hz

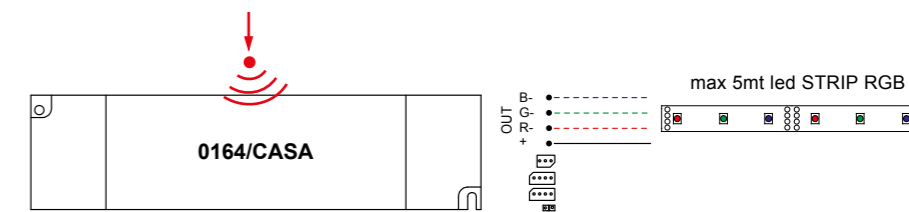
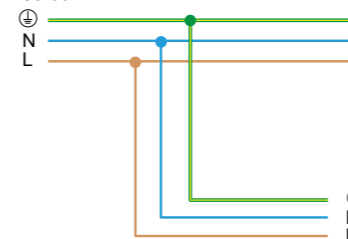

0164/CASA - RGB (120W)

220/240 Vac
50/60 Hz

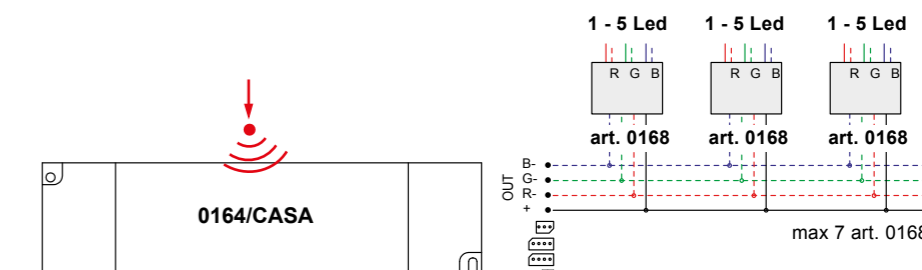
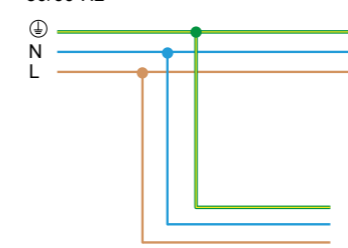



Oggi è possibile gestire numerose funzioni e differenti scenari luminosi in modo semplice e veloce tramite il proprio smartphone, smartwatches e tablet. Ne è un esempio l'applicazione CASAMBI che permette di accendere e spegnere la luce, impostare l'intensità ideale, creare scenari diversi nei luoghi di lavoro o all'interno di negozi in modo semplice e senza la presenza di installatori.

Today it is possible to manage numerous functions and different lighting scenarios quickly and easily using your smartphone, smartwatches and tablets. An example of this is the CASAMBI application that allows you to switch the light on and off, set the ideal intensity, create different scenarios in workplaces or inside shops in a simple way and without the presence of installers.

L'applicazione CASAMBI (disponibile per Android e Apple) si connette tramite bluetooth alle lampade.

The CASAMBI application (available for Android and Apple) connects via bluetooth to the lamps.

Anche l'utilizzo dell'APP è facile: basta scattare una foto delle stanze e collocare i controlli delle lampade nelle immagini stesse così da poter gestire il tutto in maniera intuitiva.

Even the use of the APP is easy: just take a photo of the rooms and place the lamp controls in the images themselves so that you can manage everything intuitively.

Le APP possono essere utilizzate da uno o più utenti ed è possibile comandare un solo apparecchio, una stanza o un gruppo di elementi.

APP can be used by one or more users and it is possible to control a single device, a room or a group of elements.

EGOLUCE propone una serie di driver TCI basati su queste tecnologie per controllare faretto, lampade ad incasso e proiettori su binario a tensione di rete 230V.

EGOLUCE proposes a series of TCI drivers based on these technologies to control spotlights, recessed lamps and 230V mains voltage track projectors.



0145/CASA



0718/CASA

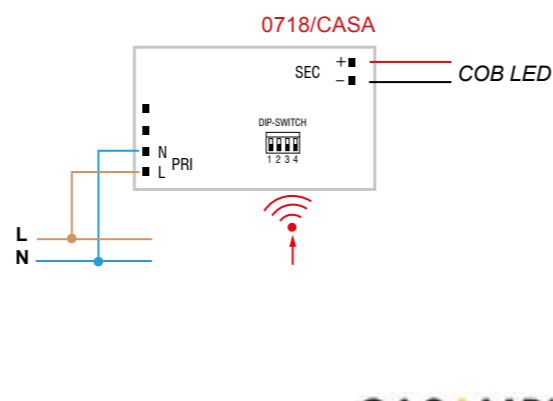
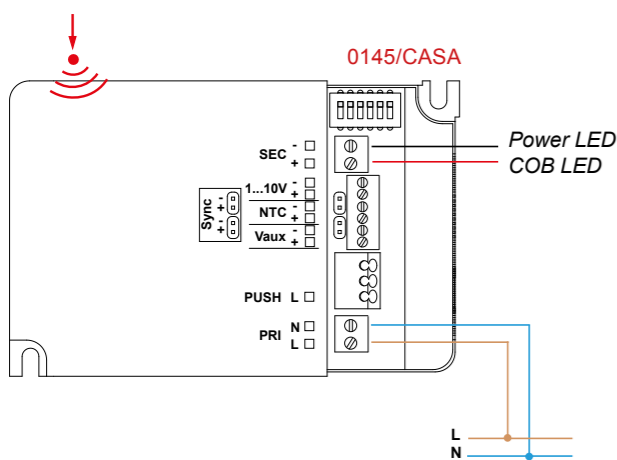

To be used through APP available on Apple Store and Play Store for iOS and Android.
Utilizzabile tramite APP disponibile su Apple Store e Play Store per sistemi iOS e Android.



Dispositivo multipotenza fornito di dip-switch per la selezione della corrente in uscita con integrato modulo wireless CASAMBI.

L'adattatore è da ordinare come articolo speciale e verrà fornito con l'apparecchio scelto. Può essere integrato con tutta la collezione NEWTON TRACK 230V e con tutte le soluzioni LED che lo permettono.

Multipower device supplied with dip-switch for the selection of the output current with integrated wireless CASAMBI module. The adapter is to be ordered as a special item and will be supplied with the chosen lamp. It can be integrated with the NEWTON TRACK 230V collection and with all the LED solutions that allow it.

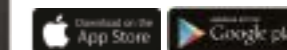
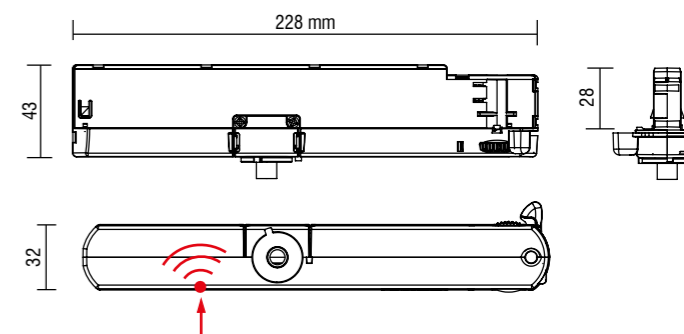

To be used through APP available on Apple Store and Play Store for iOS and Android.
Utilizzabile tramite APP disponibile su Apple Store e Play Store per sistemi iOS e Android.

0199
Kit Vetro
Kit diffuser Glass

Edy



0200/S
Kit cassaforma + Plaster
Wall Box + Plaster Kit

20,2 x 9 x 8,5h cm.

Edy



Not for 6302

0200
Cassaforma per calcestruzzo
Wall box for concrete

15,5 x 12 x 9h cm.

Edy



0201
Piastra per muratura.
Plaster kit

15 x 15 x 0,9h cm.

Edy



0206
Cassaforma tonda per installazione in cartongesso a scomparsa
Round wall box for installation in plasterboard false ceiling

- .01 Bianco - White
- .02 Nero - Black

Star 1 - Star 2 - Star IP - Star RGB

6,7 cm.



0207
Cassaforma quadrata per installazione in cartongesso a scomparsa
Square wall box for installation in plasterboard false ceiling

- .01 Bianco - White
- .02 Nero - Black

Star 1 - Star 2 - Star IP - Star RGB

5,5x5,5 cm.



- 0210/100** - 101,8 cm
- 0210/150** - 151,8 cm
- 0210/200** - 201,8 cm
- 0210/300** - 301,8 cm

Cassaforma per calcestruzzo - Wall box for concrete

Linea

0212 - Ø 2
Box + Plaster

Alcor, Byte, Cruise, Dot,
Dot Plus, Sirio, Snorky,
Top Mini, Trim, Vega

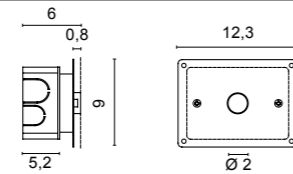

0213 - Ø 3
Box + Plaster

Cerchietto, Fire, Ice,
Pix, Top, Snorky Maxi

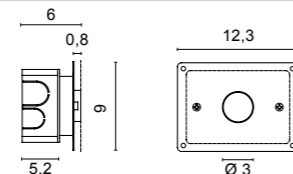

0214 - Ø 3,8
Box + Plaster

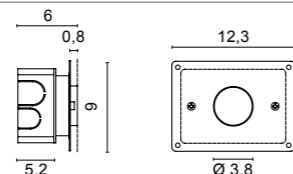

Spoon

0215 - Ø 2
Plastic Box

Alcor, Byte, Cruise, Dot,
Dot Plus, Sirio, Snorky,
Top Mini, Trim, Vega

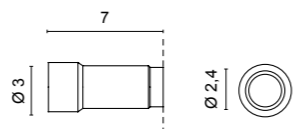

0216 - Ø 3
Plastic box

Cerchietto, Ice, Kross, Top,
Vista, Fire, Zeppelin,
Zeppelin RGB, Zeppelin Plus,
Snorky Maxi

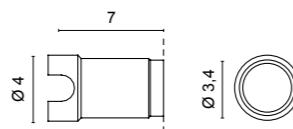

0217 - Ø 3,8
Plastic box

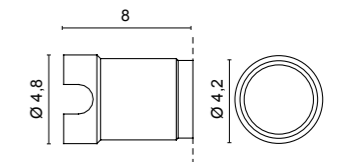

Cerchio, Cerchio RGB, Soft, Spoon

0218
Cassaforma per calcestruzzo
Wallbox for concrete

10 x 10,5 x 8,5h cm.

Edy Mini



0219
Piastra per muratura.
Plaster kit

13 x 10 x 0,7h cm.

Edy Mini



0220 - Ø 3
Kit cassaforma drenante
+ connettore stagno
Draining junction box
+ IP67 connector.

Kross, Zeppelin, Zeppelin Plus, Vista

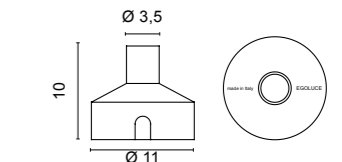

0223
Cassaforma per calcestruzzo
Wall box for concrete

9,1 x 9,5 x 9h cm.

Star

0228 - Ø 3
Cassaforma drenante
Draining junction box

Zeppelin RGB



0224/C
Piastra per muratura.
Plaster kit

Star 1 - Star 2
Star IP - Star RGB



0224/Q
Piastra per muratura.
Plaster kit

Star 3 - Star 4



0229
Kit cassaforma drenante
+ connettore stagno
Draining junction box
+ IP67 connector.

Drive

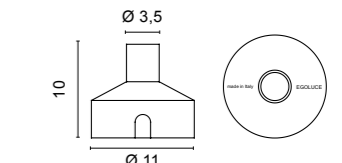

0230 - Ø 6
Kit cassaforma drenante
+ connettore stagno
Draining junction box
+ IP67 connector.

Zeppelin orientabile, Zeppelin Maxi, Zeppelin Maxi COB

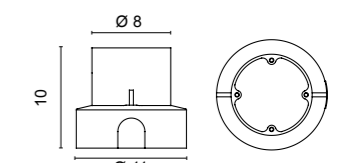

0231
Kit cassaforma drenante
+ connettore stagno
Draining junction box
+ IP67 connector.

Tris

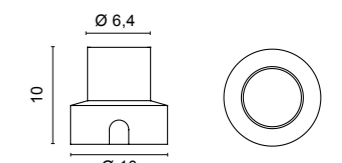

0232 - Ø 6
Plastic box da parete
Wall plastic box

Zeppelin orientabile, Zeppelin Maxi,
Step, Zen Led, Modus Led, Zeppelin Maxi COB

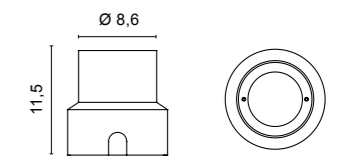

0234
Plastic box RGB



Pix, Pix RGB, Ice RGB, Vega Maxi RGB, Fire RGB, Alcor Maxi RGB

0235
Plastic box da parete
Wall plastic box

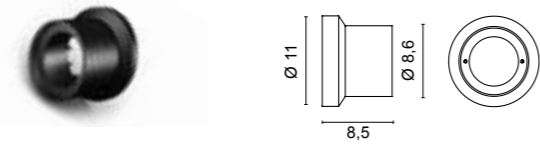

Tris

0243
Connettore IP per cavi Ø < 7.0 mm
IP Connector for cables Ø < 7.0 mm



Outdoor

Profilo in alluminio anodizzato
Anodized aluminum profile

0244/100 - 100 cm
0244/200 - 200 cm
0244/300 - 300 cm

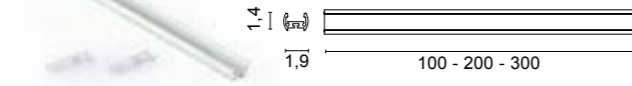

Picchetto per l'installazione
temporanea a terreno
Stake for temporary
installation on field



0246
Box + Plate



Kepl

0249
Box + Plaster
7x21x8,5 cm.

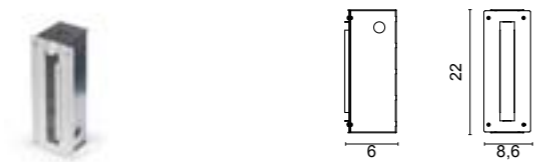

Slot

0250 - ø 3,8
Kit cassaforma drenante
+ connettore stagno
Draining junction box
+ IP67 connector.

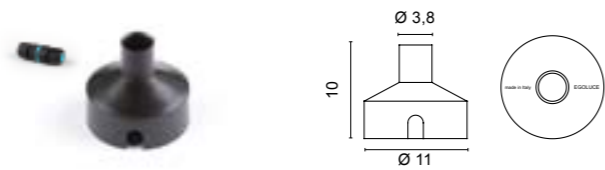

Soft, Cerchio

0251 - ø 3,8
Cassaforma drenante
Draining junction box

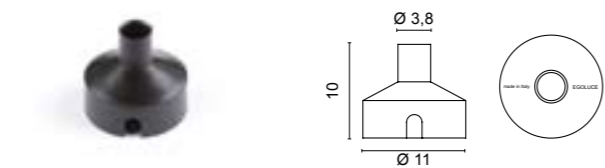

Cerchio RGB

0031/IP
IN: 220 - 240V
OUT: 350 mA - 1-10 Power leds 1W



IP67 SELV 4,2 cm.

0033/IP
IN: 220 - 240V
OUT: 24V - 14,4W



IP67 SELV 4,2 cm.

0034/IP
IN: 220 - 240V
OUT: 24V - 70W



IP67 SELV

0035/IP
IN: 220 - 240V
OUT: 24V - 160W



IP65 SELV 9,6 cm.

0036/IP
IN: 220 - 240V
OUT: 12V - 14,4W



IP67 SELV 4,2 cm.

0125
IN: 100 - 240V
OUT: 350 mA - 1-6 Power leds 1W,
1 0107



SELV 4,2 cm.

0126
IN: 110 - 240V
OUT: 700 mA - 1-6 Power leds 3W



CLASS 2 SELV 4,8 cm.

0127
IN: 100 - 240V
OUT: 500 mA - 1-6 Power leds 2W,
1 0108, 1 Dissy



CLASS 2 SELV 4 cm.

0128
IN: 100 - 240V
OUT: 350 mA - 1-10 Power leds 1W,
1-2 0107



CLASS 2 SELV 4 cm.

0130
IN: 220 - 240V
OUT: 8V - 1-40 Lucciole



4,5 cm.

LED DRIVERS

0135

IN: 220 - 240V
OUT: 500mA
600mA
700mA

CLASS 2 SELV 7,6 cm.

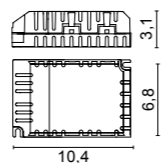

0136/15

IN: 100 - 240V
OUT: 350mA - 1-10 Power leds 2W,
1-2 Star1 - Star2 - Star3 - Sta4

SELV 3,2 cm.

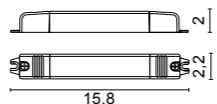

0143/IP

IN: 220 - 240V
OUT: 500 mA - 1-7 Power Leds 2W

IP67 SELV 4,5 cm.

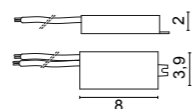

0147/COB

IN: 110 - 240V
OUT: 500 mA - 1-2 0108, 2 Dissy,
1 Vero mini, 1 Vero

SELV 4,8 cm.

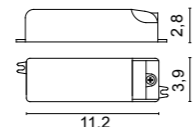

0148/COB

IN: 220 - 240V
OUT: 700 mA

SELV 4,2 cm.

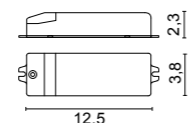

0149/COB

IN: 220 - 240V
OUT: 500 mA - 1 art. 0108, 1 Dissy

SELV 0,0 cm.

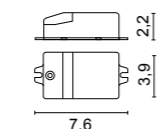

0151/150

IN: 220 - 240V
OUT: 150 mA - 1-2 Star

SELV 3,7 cm.

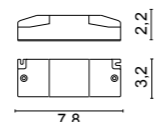

0155

IN: 100 - 240V
OUT: 24V - 13W

SELV 3,2 cm.

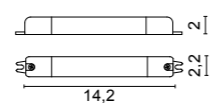

0156

IN: 100 - 240V
OUT: 24V - 25W

SELV 6 cm.

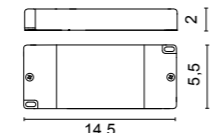

0157

IN: 220 - 240V
OUT: 24V - 75W

SELV 6,8 cm.

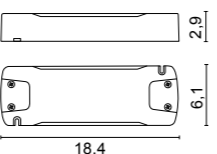

0159

IN: 100 - 240V
OUT: 12V - 25W

SELV 6 cm.

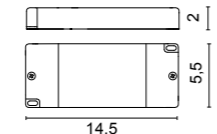

LED DRIVERS

0160

IN: 220 - 240V
OUT: 24V - 50W

SELV 6,6 cm.

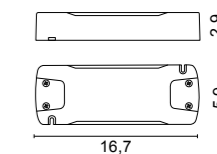

0161/100

IN: 220 - 240V
OUT: 24V - 100W

SELV 8 cm.

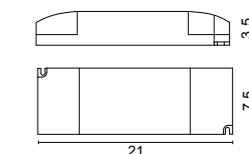

0162

IN: 220 - 240V
OUT: 24V - 150W

SELV 8 cm.

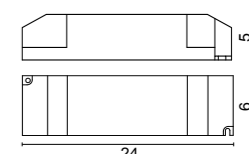

0169

IN: 220 - 240V
OUT: 350mA - 2-12 Power led 1W
500mA - 1 Vero, 1 Vero Mini,
2-12 Power led 2W
700mA

SELV 5,4 cm.

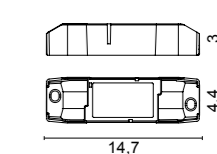

0173

IN: 100 - 240V
OUT: 12V - 50W

SELV 7 cm.

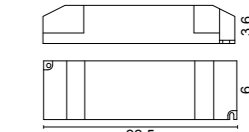

DIMMER

0110/DIM

IN: 12/24V 12A MAX
OUT: 12/24V

PUSH 1...10 V DALI SELV 5,6 cm.

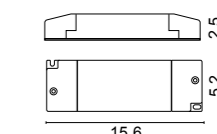

0112/48/DIM

IN: 12/24/48V
OUT: 12/24/48V 6,5A

PUSH 1...10 V 5 cm.

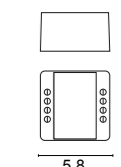

0112/48/DALI

IN: 12/24/48V
OUT: 12/24/48V 6,5A

DALI 5 cm.

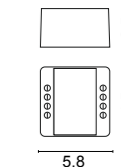

DIMMABLE LED DRIVERS

0129

IN: 110 - 240V
 OUT: 350 mA - 4-15 power leds, 1-2 COB (art.0107)
 500 mA - 1-14 power leds, 1-2 COB (art.0108)
 700 mA - 1-13 power leds

PUSH **1...10 V** **CE** **UL** **US** SELV \varnothing 7,2 cm.



0129/DALI

IN: 110 - 240V
 OUT: 350 mA - 2-12 power leds, 1-2 COB (art.0107)
 500 mA - 2-12 power leds, 1-2 COB (art.0108)
 700 mA - 2-12 leds
 12V DC - 10W
 24V DC - 20W

DALI **CE** **UL** **US** SELV \varnothing 7,2 cm.

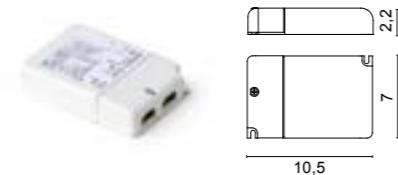

0141/DALI

IN: 110 - 240V
 OUT: 350 mA - 1-12 power leds, 1-2 COB (art.0107)
 500 mA - 1-11 power leds, 1-2 COB (art.0108)
 700 mA - 1-8 power leds

DALI **CE** **UL** **US** \varnothing 5,5 cm.

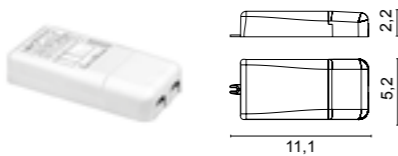

0141/DIM

IN: 110 - 240V
 OUT: 350 mA - 1-12 power leds, 1-2 COB (art.0107)
 500 mA - 1-11 power leds, 1-2 COB (art.0108)
 700 mA - 1-8 power leds

PUSH **1...10 V** **CE** **UL** **US** \varnothing 5,5 cm.

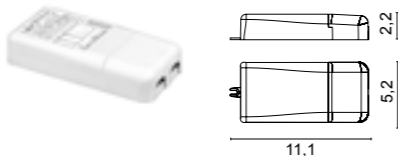

0145

IN: 110 - 240V
 OUT: 350 mA - 1- 21 power leds, 1-3 COB (art.0107)
 500 mA - 1-21 power leds, 1-3 COB (art.0108)
 700 mA - 1-21 power leds

PUSH **1...10 V** **CE** **UL** **US** SELV \varnothing 8,4 cm.

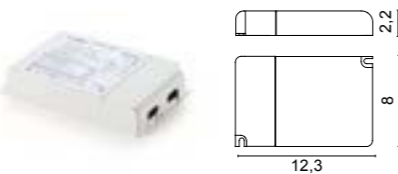

0145/DALI

IN: 110 - 240V
 OUT: 350 mA - 1- 21 power leds, 1-3 COB (art.0107)
 500 mA - 1-21 power leds, 1-3 COB (art.0108)
 700 mA - 1-21 power leds

PUSH **1...10 V** **DALI** **CE** **UL** **US** SELV \varnothing 8,4 cm.

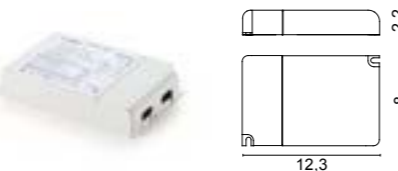

0133

Cavo di sincronizzazione per dimmer Led
 Synchronization cable for dimmer Led



0129, 0129 DALI, 0145, 0145 DALI

0717/DIM60

IN: 220 - 240V
 OUT: 24V - 60W

PUSH **1...10 V** SELV \varnothing 8,6 cm.



0717/DIM100

IN: 220 - 240V
 OUT: 24V - 100W

PUSH **1...10 V** **DALI** SELV \varnothing 8,2 cm.

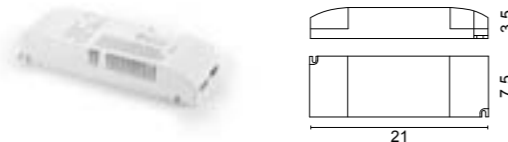

DIMMABLE LED DRIVERS

0717/DIM150

IN: 220 - 240V
 OUT: 24V - 150W

PUSH **1...10 V** **DALI** SELV \varnothing 8,2 cm.

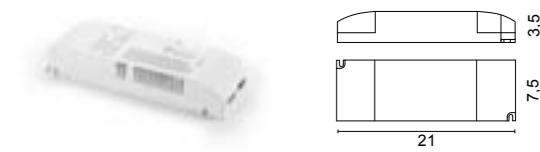

0726/DIM

Dimmable driver
 TAGLIO DI FASE (IGBT-TRIAC, TRAILING EDGE-LEADING EDGE)
 PHASE CUT-OFF (IGBT-TRIAC, TRAILING EDGE-LEADING EDGE)

IN: 220 - 240V
 OUT: 24V - 20W

350 mA - 1-12 power leds, 1-2 COB (art.0107)
 500 mA - 1-12 power leds, 1-2 COB (art.0108)
 700 mA - 1- 9 power leds
 2 DISSY - 1 VERO MINI - 1VERO

PUSH IGBT/TRIAC **CE** **UL** **US** SELV \varnothing 5,6 cm.

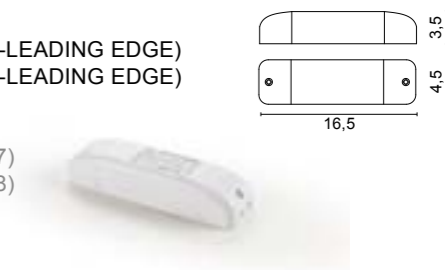

0727/DIM

Dimmable driver
 TAGLIO DI FASE (TRIAC, TRAILING EDGE-LEADING EDGE)
 PHASE CUT-OFF (TRIAC, TRAILING EDGE-LEADING EDGE)

IN: 220 - 240V
 OUT: 24V - 45W

TRIAC SELV \varnothing 8,2 cm.

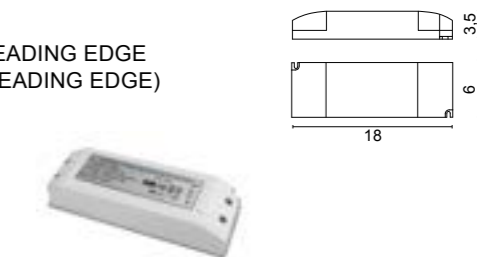

DMX INTERFACE

0729/DMX

Convertitore di segnale DMX - PWM
 DMX - PWM Signal converter
 IN: 100 - 240V

0164, 0167

0166

Cavo di sincronizzazione
 Synchronization cable

0164, 0167, 0729/DMX

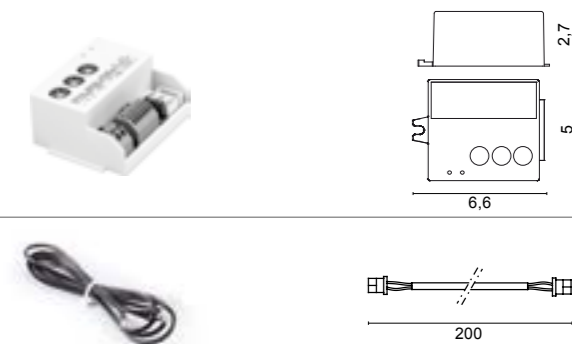

LED EMERGENCY UNIT

0115/EM

Kit Inverter + Battery

0115/EM/3

Kit Inverter + Battery 3h.

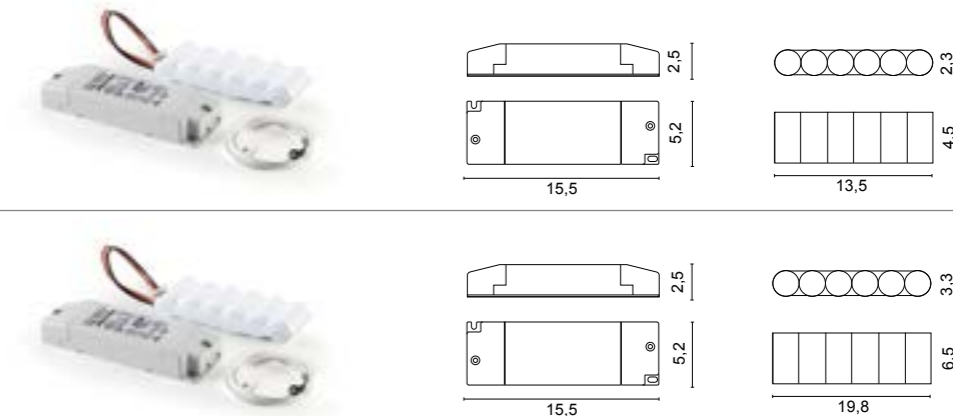

RGB DRIVERS

0167 Driver RGB 22W
IN: 220-240V
OUT: 3x24V

PUSH Remote 5,6 cm.



0164 Driver RGB 120W
IN: 220-240V
OUT: 3x24V

PUSH Remote 8 cm.



0168 Converter
IN: 3x24V
OUT: 3x250 mA 1-5 RGB



0163 IR Receiver

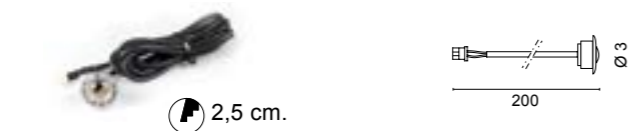

0164, 0167

0165 IR Remote Controller



0166
Cavo di sincronizzazione
Synchronization cable



0164, 0167

0152
Kit Lucciola RGB - art. 6353
Centralina RGB + Telecomando
RGB controller + Remote control



Centraline RGB non sincronizzabili tra loro
RGB controller cannot be synchronized with each other

WIRELESS BLUETOOTH DRIVERS

0718/CASA
Alimentatori multipotenza in corrente continua regolabili wireless.

Direct current dimmable wireless multipower drivers.

IN: 220-240V
OUT: max 38W

CASAMBI **PUSH** 5,4 cm.



0145/CASA
Alimentatori multipotenza in corrente continua regolabili wireless.

Direct current dimmable wireless multipower drivers.

IN: 220-240V
OUT: max 60W

CASAMBI **PUSH** 8,4 cm.



0164/CASA Driver RGB 120W
Alimentatori multipotenza in corrente continua regolabili wireless.

Direct current dimmable wireless multipower drivers.

IN: 220-240V
OUT: 3x24V
CASAMBI 8 cm.



WIFI SWITCH

0070/WIFI
Interruttore WIFI ON/OFF con controllo vocale.
Smart WIFI switch ON/OFF with voice control.

IN: 100-240V 50/60Hz
OUT: max 500W

4 cm.



SWITCH DIMMER E27

0074/DIM
Variatore universale per lampade ad incandescenza con attacco E27 purchè siano del tipo dimmerabile. Il dispositivo è azionabile tramite uno o più pulsanti normalmente aperti

Universal dimmer to adjust all the incandescent LAMPS, provided the type dimmable. The device can be operated by one or more push buttons.

IN: 220-240V 50/60Hz
OUT: 3-50W

LED

POWER LED



Color temperature	Optics	Light sources	lm
0120	4000K 25°	POWER LED max 2W 500mA	209lm
0122	3000K 25°	POWER LED max 2W 500mA	199lm

POWER LED



Color temperature	Optics	Light sources	lm
0121	4000K 25°	POWER LED max 3x3W 700mA	846lm
0123	3000K 25°	POWER LED max 3x3W 700mA	804lm

COB LED



Color temperature	Optics	Light sources	lm
0107/CW	5000K /24 /40 /60	COB LED 6,1W 17,3V 350mA	1066lm
0107/W	4000K /24 /40 /60	COB LED 6,1W 17,3V 350mA	975lm
0107/WW	3000K /24 /40 /60	COB LED 6,1W 17,3V 350mA	939lm
0107/XW	2700K /24 /40 /60	COB LED 6,1W 17,3V 350mA	896lm
0108/CW	5000K /24 /40 /60	COB LED 8,9W 17,8V 500mA	1480lm
0108/W	4000K /24 /40 /60	COB LED 8,9W 17,8V 500mA	1353lm
0108/WW	3000K /24 /40 /60	COB LED 8,9W 17,8V 500mA	1303lm
0108/XW	2700K /24 /40 /60	COB LED 8,9W 17,8V 500mA	1244lm
0108/W/IP	4000K /24 /38 /58	COB LED IP44 8,9W 17,8V 500mA	1353lm
0108/WW/IP	3000K /24 /38 /58	COB LED IP44 8,9W 17,8V 500mA	1303lm

0092/16 50/60Hz 220-240V
3,5W G9 LED 330lm 3000K

0093/19 50/60Hz 220-240V
3W GU10 LED 200lm 3000K

0094/16 50/60Hz 220-240V
7W GU10 LED 600lm 3000K

0104/16 50/60Hz 220-240V
7W GU10 LED 530lm 3000K
Dimmerabile - Dimmable

0105/12 50/60Hz 220-240V
12W E27 LED 1055lm 3000K

0105/15 50/60Hz 220-240V
15W E27 LED 1521lm 3000K

0105/30 50/60Hz 220-240V
30W E27 LED 3000lm 3000K

0105/MINI 50/60Hz 220-240V
6W E14 LED 600lm 3000K

0105/GLOBO 50/60Hz 220-240V
21W E27 LED 1950lm 3000K

230V HALO

0072 50W GU10

ONLY FOR LED VERSIONS



Dischi reggi lampadina
Dischi in metacrilato per il fissaggio del modulo LED da utilizzare come alternativa alle molle a filo.
Disponibili in finitura trasparente (TR) o satinata (ST).

Bulb fixers
Methacrylate disks for fixing LED module to be used instead of the wire springs.
Available in clear finish (TR) or satin (ST).

AVAILABLE FOR:



EXAMPLES:



INDEX

CODICE	PRODOTTO	Pag
1171	LANCIA TONDA CAVO	178
1172	LANCIA TONDA CAVO	178
1173	LANCIA TONDA CAVO	178
1543	RAIL SYSTEM SUSPENSION	150
1544	RAIL SYSTEM SUSPENSION	150
1565	LANCIA CAVO	176
1598	EDISON SYSTEM SUSPENSION	230
3502	KEPI'	244
4510	VISION 1	246
4511	VISION 3	247
4515	PLANA	186
4520	MARGO	184
4521	EXTRA	182
4522	MAGIKA	188
4523	MAGIKA	188
4536	WANDA	258
4537	WANDA	258
4538	WANDA RGB	258
4539	WANDA RGB	258
4555	VISION 3 COB	247
4559	GEO MONOEMISSIONE	248
4560	GEO BIEMISSIONE	248
4580	RAIL SYSTEM WALL	154
4581	RAIL SYSTEM WALL	154
5511	ASTRA - 15W/mt	194
5542	RAIL SYSTEM CEILING/WALL	144
5543	RAIL SYSTEM CEILING/WALL	144
5552	ASTRA - 9,6W/mt	194
5552	ASTRA - 4,8W/mt	194
5612	EDISON SYSTEM CEILING	230
6024	SPECCHIO INCASSO	72
6028	SPECCHIO LUNGO	72
6030	SPECCHIO CORTO	72
6048	GEKO QUADRO ADJUSTABLE	64
6056	GEKO QUADRO ADJUSTABLE 230V	64
6204	STELLA	71
6234	TUBO MINI	69
6238	CORNO MINI 230V	70
6240	CORNO 12V	70
6241	CORNO 230V	70
6249	GAMMA	71
6251	ZEN	66
6263	EOS PIU'	71
6265	MODUS	67
6290	GEKO 230V	61
6298	EDY MINI	52
6299	EDY 45° MINI	52
6302	EDY 230V	55
6305	EDY LED	54
6313	SNORKY MAKI	199
6316	DOT PLUS TONDO	201
6317	DOT PLUS QUADRO	201

CODICE	PRODOTTO	Pag
6318	TAPPO ADJUSTABLE	44
6319	TAPPO ADJUSTABLE 230V	45
6320	DOT TONDO	200
6321	DOT QUADRO	200
6322	PIX TONDO	222
6323	PIX QUADRO	222
6324	OCCHIO LED	68
6325	TAPPO MINI 230V	40
6326	NEWTON SPOT EASY 230V - GU10	135
6327	TAPPO MINI	40
6328	NEWTON SPOT RECESSED	134
6329	TAPPO 230V	43
6330	TAPPO	42
6336	TRIM TONDO BIEMISSIONE	202
6337	TRIM QUADRO BIEMISSIONE	202
6338	TRIM TONDO MONOEMISSIONE	202
6339	TRIM QUADRO MONOEMISSIONE	202
6340	FIRE	204
6341	FIRE RGB	205
6342	NEWTON SPOT	130
6343	NEWTON TRACK 48V	110
6344	NEWTON TRACK 48V	110
6344	NEWTON SPOT	130
6345	NEWTON TRACK 48V	110
6347	NEWTON RAIL	136
6348	ZEPPELIN TONDO	262
6349	ZEPPELIN QUADRO	262
6350	SPOON TONDO	206
6351	SPOON QUADRO	206
6353	LUCCIOLA RGB	209
6354	ICE TONDO	210
6355	ICE QUADRO	210
6356	BYTE TONDO	212
6357	BYTE QUADRO	212
6358	VEGA	216
6359	SIRIO	214
6360	ALCOR	218
6361	KROSS	275
6362	VISTA	276
6363	TOP	220
6364	TOP MINI	220
6365	ZEN LED	66
6366	DRIVE	277
6368	ZEPPELIN MAXI TONDO	267
6369	STEP QUADRO	274
6370	NEWTON TRACK 230V	120
6371	TRIS	270
6372	LUCCIOLA	208
6373	SNORKY	198
6374	NEWTON PLUS TRACK 230V	126
6375	PIX TONDO RGB	223
6376	ZEPPELIN TONDO RGB	263

CODICE	PRODOTTO	Pag
6377	ICE QUADRO RGB	211
6378	VEGA MAXI RGB	217
6379	ALCOR MAXI RGB	219
6381	SLOT	225
6382	CRUISE	224
6383	ZEPPELIN MAXI QUADRO	267
6384	ZEPPELIN TONDO 25 PLUS	264
6387	STEP TONDO	274
6388	SOFT	271
6389	CERCHIO	272
6390	CERCHIO RGB	273
6391	CERCHIETTO	224
6394	ZEPPELIN QUADRO25 PLUS	264
6395	ZEPPELIN QUADRO RGB	263
6397	ZEPPELIN MAXI COB	266
6398	MODUS LED	67
6409	DISSY QUADRO	32
6410	DISSY TONDO	33
6411	ZEPPELIN ORIENTABILE	268
6415	ROTONDO	86
6416	ROTONDO 230V	87
6417	SPOOK	252
6418	SPOOK	252
6419	SPOOK	252
6426	VERO MINI QUADRO	48
6427	VERO QUADRO	48
6431	EASY QUADRO LED	36
6432	EASY QUADRO 230V	36
6433	VERO MINI TONTO	49
6434	VERO TONDO	49
6441	EASY TONDO LED	37
6442	EASY TONDO 230V	37
6447	GEKO ADJUSTABLE	63
6448	NEWTON FLAT TRACK 48V	114
6449	NEWTON FLAT TRACK 48V	114
6450	NEWTON FLAT TRACK 48V	114
6451	NEWTON SLIM TRACK 48V	112
6452	NEWTON SLIM TRACK 48V	112
6455	GEKO ADJUSTABLE 230V	61
6460	GEKO	62
6461	NEWTON FLAT TRACK 230V	124
6462	NEWTON FLAT TRACK 230V	124
6463	NEWTON FLAT TRACK 230V	124
6464	NEWTON SLIM TRACK 230V	122
6465	NEWTON SLIM TRACK 230V	122
6466	NEWTON TRACK 230V	120
6467	NEWTON TRACK 230V	120
6468	NEWTON FLAT SPOT	133
6469	NEWTON FLAT SPOT	133
6470	NEWTON SLIM SPOT	132
6471	NEWTON SLIM SPOT	132
6474	NEWTON SLIM RAIL	138
6475	NEWTON FLAT RAIL	138

CODICE	PRODOTTO	Pag
6480	NEWTON EASY TRACK 230V - GU10	129
6481	NEWTON EASY 230V - GU10	131
6492	DELTA MINI LED	57
6560	GEKO EDISON SPOT E27	234
6561	TAPPO EDISON SPOT E27	234
6605	MIRAGE MINI LED	90
6607	GHOST MAXI LED	84
6608	GHOST LED	83
6609	MIRAGE LED	91
6615	LINEA	166
6616	LINEA	166
6617	LINEA RGB	166
6618	LINEA RGB	166
6621	CASPER 230V	80
6622	CASPER LED	81
6624	GHOST MINI LED	82
6624	ZERO 230V	88
6625	ZERO LED	89
6627	QUADRATO 230V	78
6628	QUADRATO LED	79
6649	PHANTOM SYSTEM DIMM 1...10V	104
6650	PHANTOM SYSTEM	100
6653	PHANTOM SYSTEM DIMM DALI	104
6654	MIRAGE MAXI LED	92
6655	LINEA MAXI	170
6656	LINEA MAXI	170
6657	LINEA MAXI RGB	170
6658	LINEA MAXI RGB	170
6660	RAIL SYSTEM RECESSED	160
6661	INTO	190
6662	WOODY	192
6671	NIHIL TONDO 230V	95
6671	NIHIL QUADRO 230V	97
6672	NIHIL TONDO LED	95
6672	NIHIL QUADRO LED	97
6676	NIHIL TONDO MINI 230V	94
6677	NIHIL QUADRO MINI 230V	96
6680	GEKO MINI	60
6681	GEKO MINI ADJUSTABLE 230V	60
6689	STAR ZERO	76
6690	STAR 1	18
6691	STAR 2	18
6692	STAR IP	20
6693	STAR RBG	21
6695	STAR 3	22
6696	STAR 4	23
6698	SNORKY INCASSO	69
6705	STAR MAXI TONDO	26
6706	STAR MAXI TONDO	26
6707	STAR MAXI QUADRO	28
6708	STAR MAXI QUADRO	28



I nostri prodotti sono costruiti in conformità alle norme europee CEI-EN 60598 e, come tali, recano la marcatura CE.

Our fittings are manufactured in conformity with the european standard CEI-EN 60598 and, consequently, get the mark CE.

Nos appareils sont fabriqués en conformité aux règles européennes CEI-EN 60598 et, par conséquence, fournis avec marque CE.

Unsere Produkte werden gemäss europäischer Norm CEI-EN 60598 hergestellt und sind als solche mit dem CE-Zeichen gekennzeichnet.

Nuestros productos son fabricados de conformidad con las normas europeas UNE EN 60598 y, como tal, lleva la marca CE.

Наши изделия изготовлены в соответствии с европейскими нормами CEI-EN 60598 и поэтому отмечены знаком CE.

Egoluce s.r.l. si riserva la facoltà di modificare, in qualsiasi momento e senza preavviso, le caratteristiche tecniche dei modelli illustrati nel presente catalogo.
I colori si intendono indicativi.

Egoluce s.r.l. reserves the right to change, at any time and without prior warning, the technical specification of any product illustrated in this catalogue.
Colours are simply indicative of the real nuance.

Egoluce s.r.l. se réserve le droit de modifier, à n'importe quel moment et sans préavis, les caractéristiques techniques des éléments illustrés dans ce catalogue.
Les couleurs sont simplement a titre indicatif.

Egoluce s.r.l. behält sich vor, jederzeit und fristlos die in beiliegendem Katalog erläuterten technischen Daten zu ändern.
Die Farben sind nicht genau wirklichkeitsgetreu.

Egoluce s.r.l. Nos reservamos el derecho de cambiar, en cualquier momento y sin previo aviso de las especificaciones de los productos mostrados en este catálogo.
Los colores son aproximados.

Фабрика Egoluce s.r.l. сохраняет за собой право в любое время и без предварительного уведомления менять технические спецификации любого изделия в этом каталоге.

EDITION

January 2020 © All rights reserved

ART DIRECTION, LAYOUT, GRAPHICS

U.T. Egoluce

PHOTOS

Bordegoni s.r.l.

PRINTING

Rotolito - Italy

Egoluce s.r.l. si riserva la facoltà di modificare, in qualsiasi momento e senza preavviso, le caratteristiche tecniche dei modelli illustrati nel presente catalogo.
I colori si intendono indicativi.

Egoluce s.r.l. reserves the right to change, at any time and without prior warning, the technical specification of any product illustrated in this catalogue.
Colours are simply indicative of the real nuance.

Gradi di protezione - IP

Simboli - Signs

1a cifra protezione alla penetrazione di corpi solidi.
1st digit: protection against penetration by solid bodies.

2a cifra protezione contro la penetrazione d'acqua.
2nd digit: protection against penetration by water.

0
Non protetto.
No protection.

0
Non protetto.
No protection.

1
Protetto da corpi solidi superiori a 50mm.
Protected against solid matters (over 50mm).

1 
Protetto contro la caduta verticale di gocce d'acqua.
Protected against drops of water falling vertically.

2
Protetto da corpi solidi superiori a 12mm.
Protected against solid matters (over 12mm).

3 
Protetto contro la pioggia.
Rain proof fixture.

3
Protetto da corpi solidi superiori a 2,5mm.
Protected against solid matters (over 2,5mm).

4 
Protetto contro gli spruzzi.
Splash proof fixture.

4
Protetto da corpi solidi superiori a 1mm.
Protected against solid matters (over 1mm).

5 
Protetto contro getti d'acqua.
Water jet proof.

5 
Protetto contro la polvere.
Dust proof.

6
Protetto contro le ondate.
Wave proof.

6 
Totalmente protetto contro la polvere.
Fully dust proof.

7 
Protetto contro immersione.
Watertight immersion fixture.



Foro incasso.
Cut out.

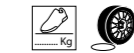

Apparecchi calpestabili - Apparecchi carrabili
Walk over fitting - Drive over fittings



Temperatura superficiale <.....°C
Surface temperature <.....°C



Alimentatore incluso – Alimentatore non incluso
Converter included – Converter not included



Lunghezza cavo
Cable length



Dimmer incluso
Dimmer included



CRI > 90 Indice di resa cromatica
CRI > 90 Color rendering index



Apparecchio riparabile
Fixture repairable

Marchi - Mark



Apparecchio in Classe II, munito di isolamento doppio o rinforzato.

Fixture on Class II, with double or reinforced insulation.



Apparecchio a bassissima tensione con trasformatore remoto.

SELV fixture with remote transformer.



Apparecchio adatto ad essere installato su superfici normalmente infiammabili.

Fixture ready for installation on normally inflammable surfaces.



MADE IN ITALY

EGOLUCE s.r.l. Via I. Newton, 12 - 20016 Pero - Milano - Italy - Tel. +39 02339586.1 - Italia fax +39 023535112
Int. fax +39 0233911087 E-mail: info@egoluce.com - Int. E-mail: infoworld@egoluce.com - www.egoluce.com